

US00D525683S

(12) **United States Design Patent**
Schaffeld et al.

(10) **Patent No.:** **US D525,683 S**

(45) **Date of Patent:** **** Jul. 25, 2006**

(54) **FAUCET SPOUT**

(75) Inventors: **John Schaffeld**, Marshfield, MA (US);
Steffen Koury, Charlestown, MA (US)

(73) Assignee: **Masco Corporation of Indiana**,
Indianapolis, IN (US)

(**) Term: **14 Years**

(21) Appl. No.: **29/220,078**

(22) Filed: **Dec. 23, 2004**

(51) **LOC (8) Cl.** **23-01**

(52) **U.S. Cl.** **D23/257; D23/255**

(58) **Field of Classification Search** **D23/238-257;**
4/675-678; 137/801

See application file for complete search history.

(56) **References Cited**

U.S. PATENT DOCUMENTS

D33,860 S	*	1/1901	Glauber	D23/238
D384,729 S	*	10/1997	Fabian	D23/238
D387,417 S	*	12/1997	Doughty et al.	D23/243
D396,092 S	*	7/1998	Haug et al.	D23/238
D399,923 S	*	10/1998	Ko	D23/238
D412,969 S	*	8/1999	Brattoli et al.	D23/255
D418,583 S	*	1/2000	Hyde et al.	D23/255
D432,215 S	*	10/2000	Spangler	D23/249

D466,591 S	*	12/2002	Lord	D23/249
D469,166 S	*	1/2003	Lim	D23/255
D469,516 S	*	1/2003	Lim	D23/255
D488,537 S	*	4/2004	Shahar	D23/238
D501,671 S	*	2/2005	Bayer	D23/238
D510,977 S	*	10/2005	Jones	D23/238
D513,060 S	*	12/2005	Ouyoung	D23/238
D515,672 S	*	2/2006	Chu	D23/249

* cited by examiner

Primary Examiner—Louis S. Zarfes

Assistant Examiner—Gregory Andoll

(74) *Attorney, Agent, or Firm*—Kwadjo Adusei-Poku;
Lloyd D. Doigan

(57) **CLAIM**

The ornamental design for a faucet spout, as shown and described.

DESCRIPTION

FIG. 1 is a front perspective view of a faucet spout showing our design;

FIG. 2 is a front elevational view thereof;

FIG. 3 is a rear elevational view thereof;

FIG. 4 is a right side elevational view, the left side elevational view being a mirror image thereof;

FIG. 5 is a top plan view thereof; and,

FIG. 6 is a rear perspective view thereof.

1 Claim, 6 Drawing Sheets

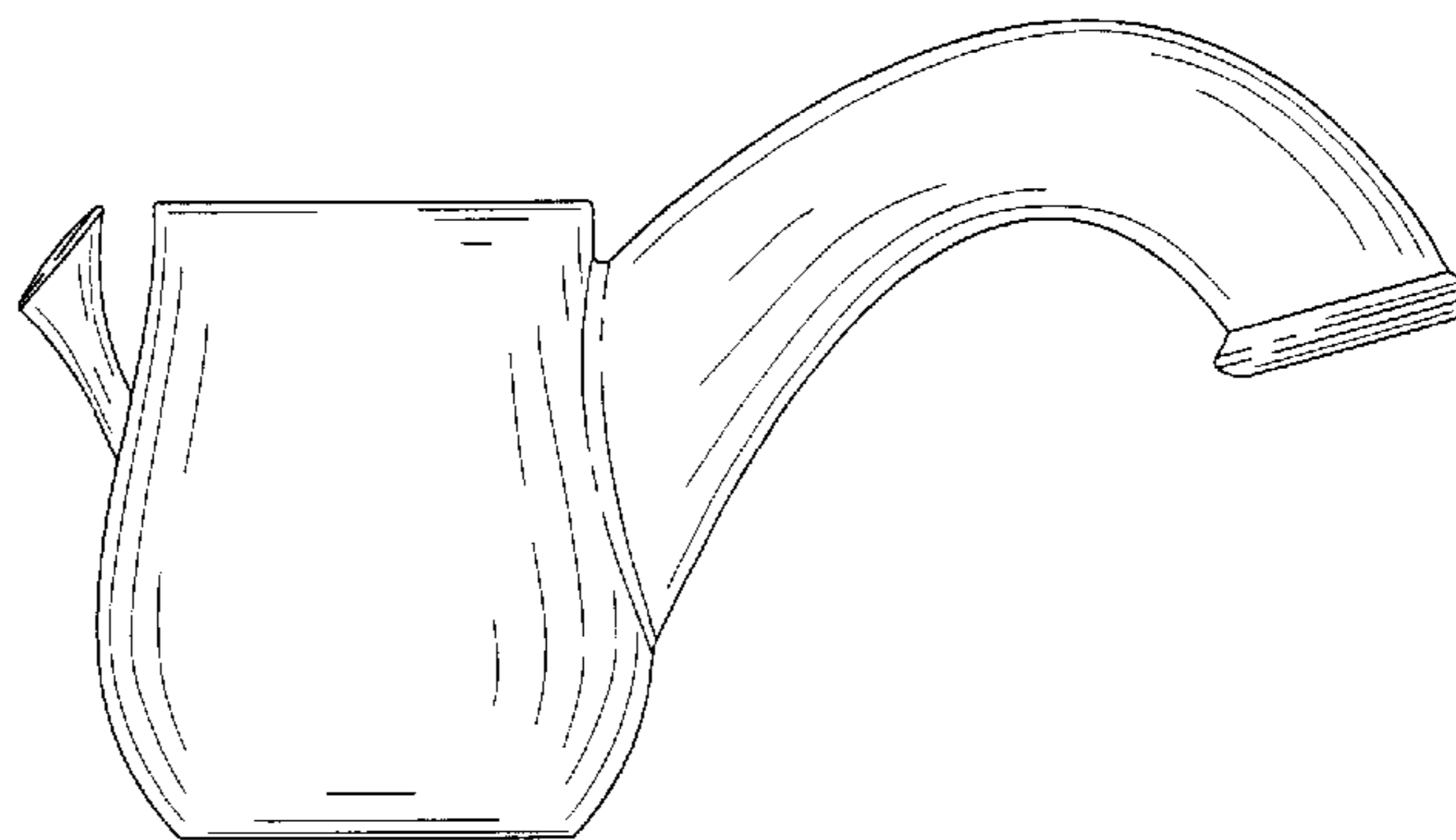
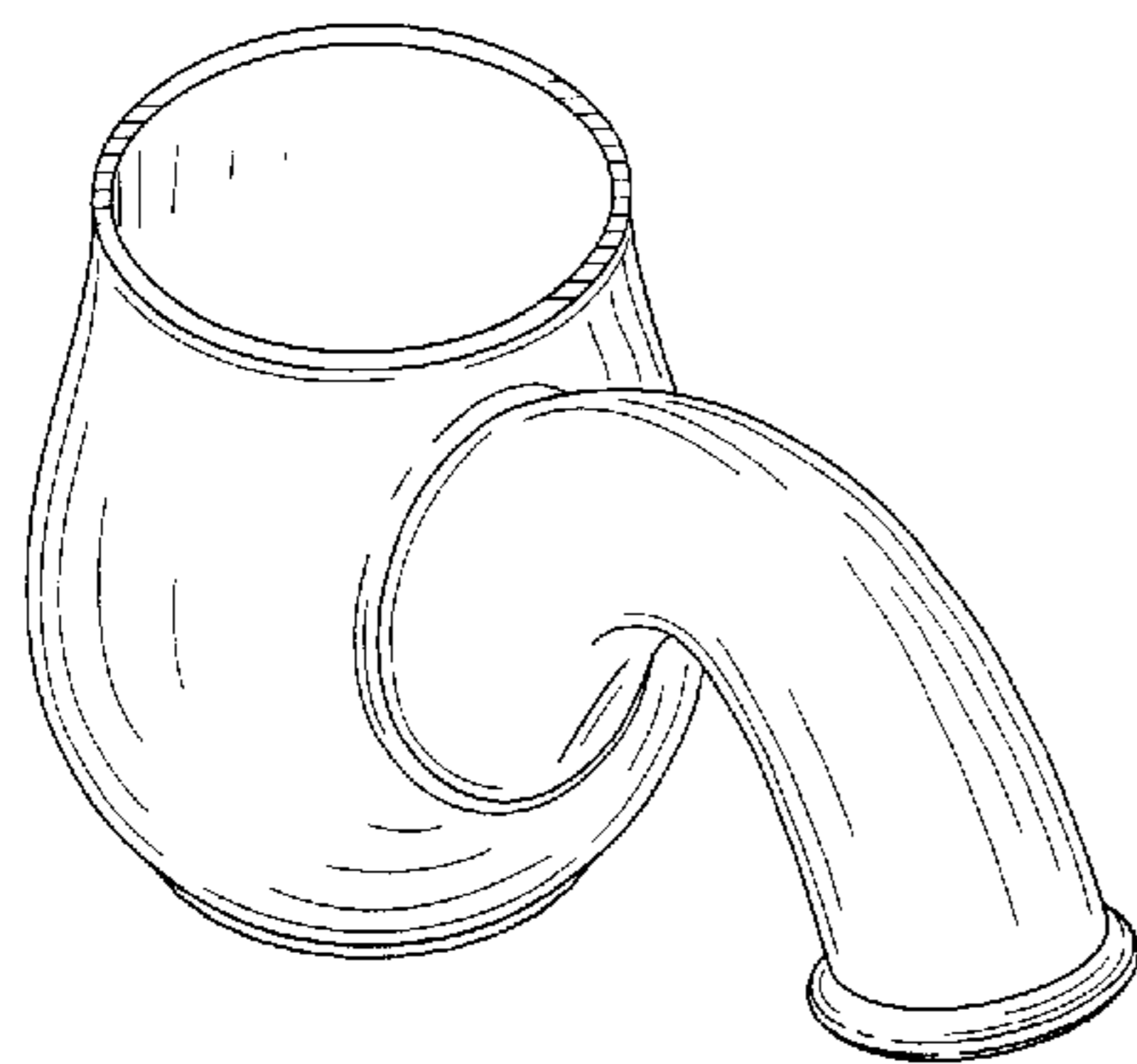

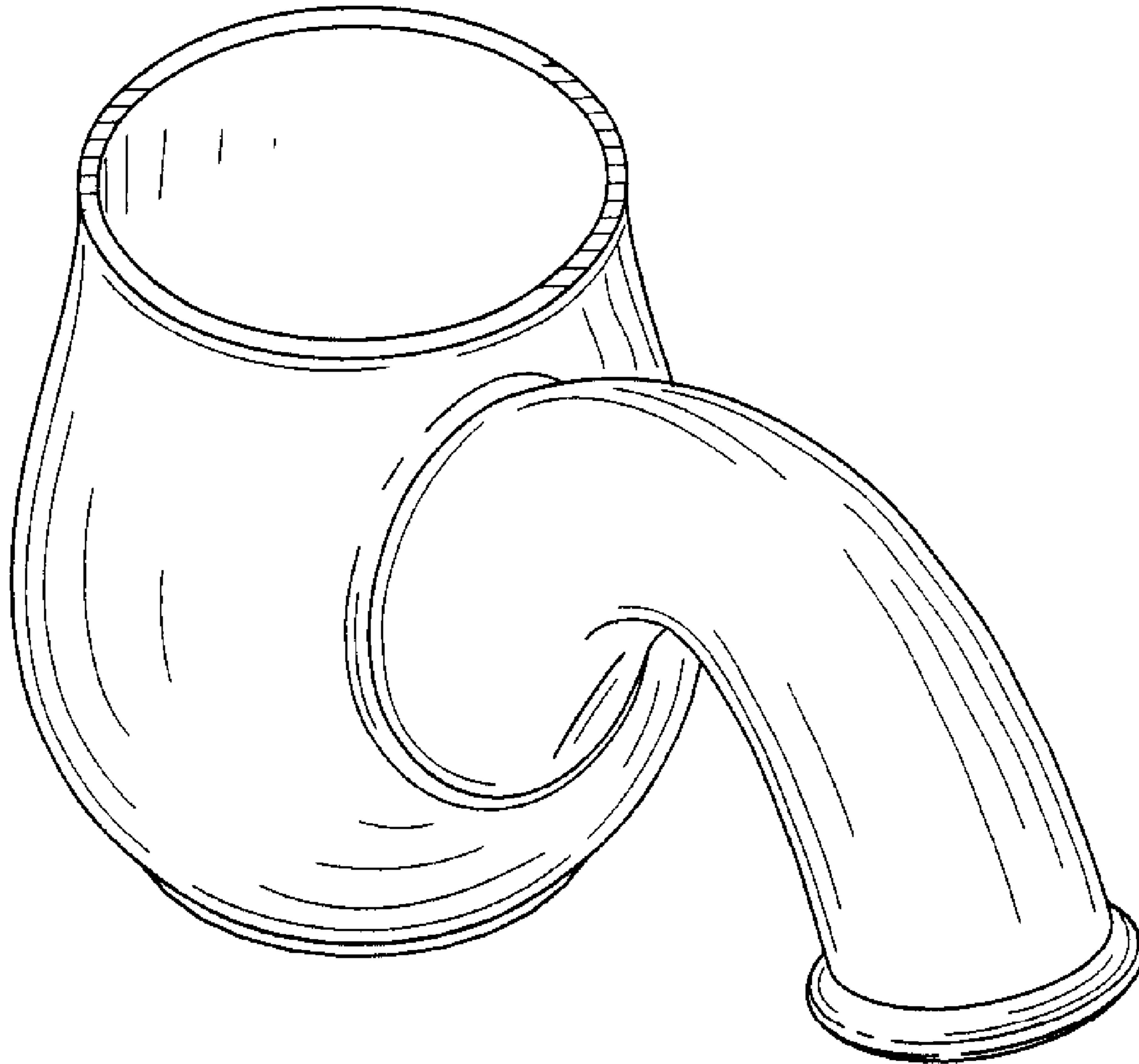

FIG. 1

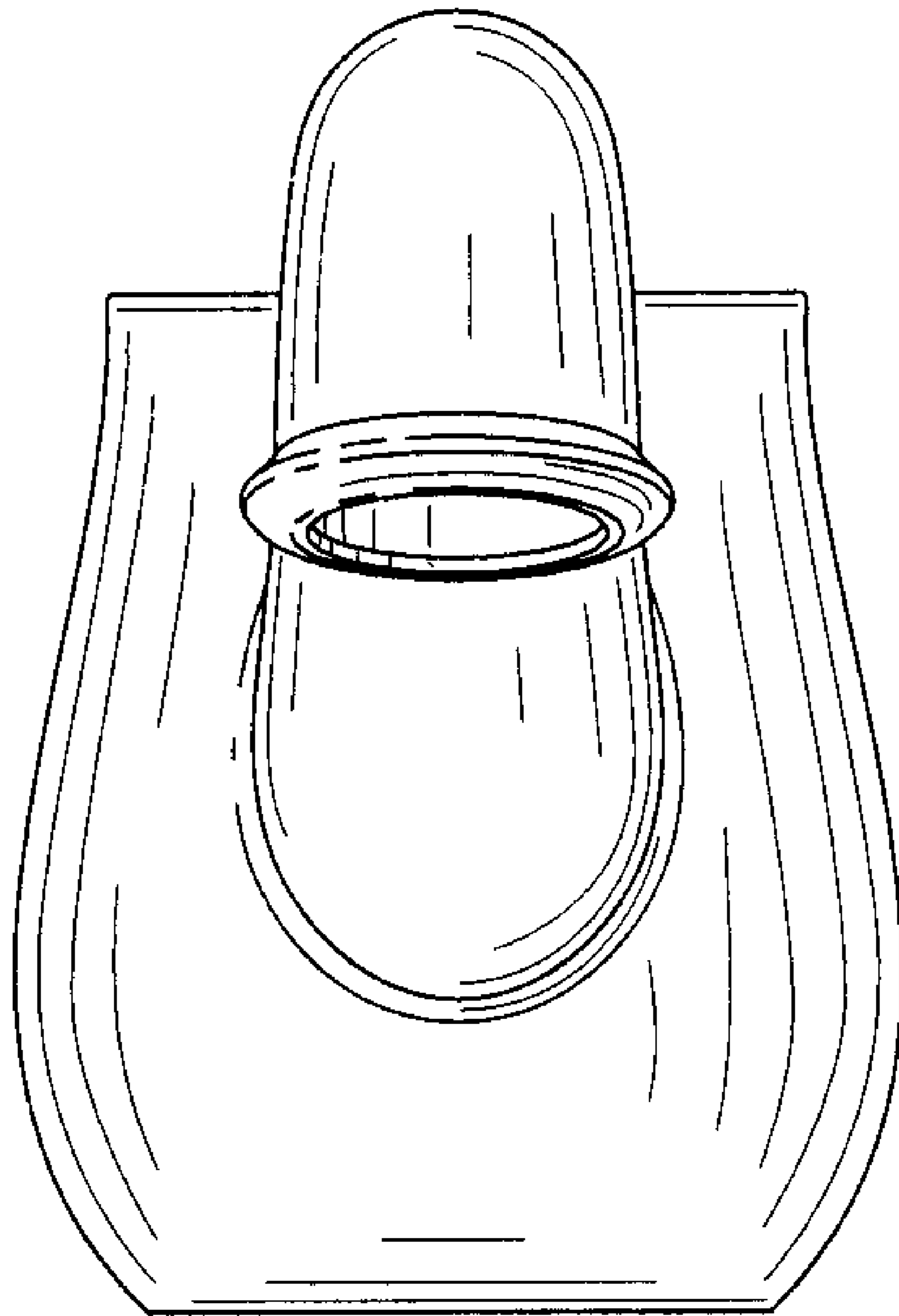

FIG. 2

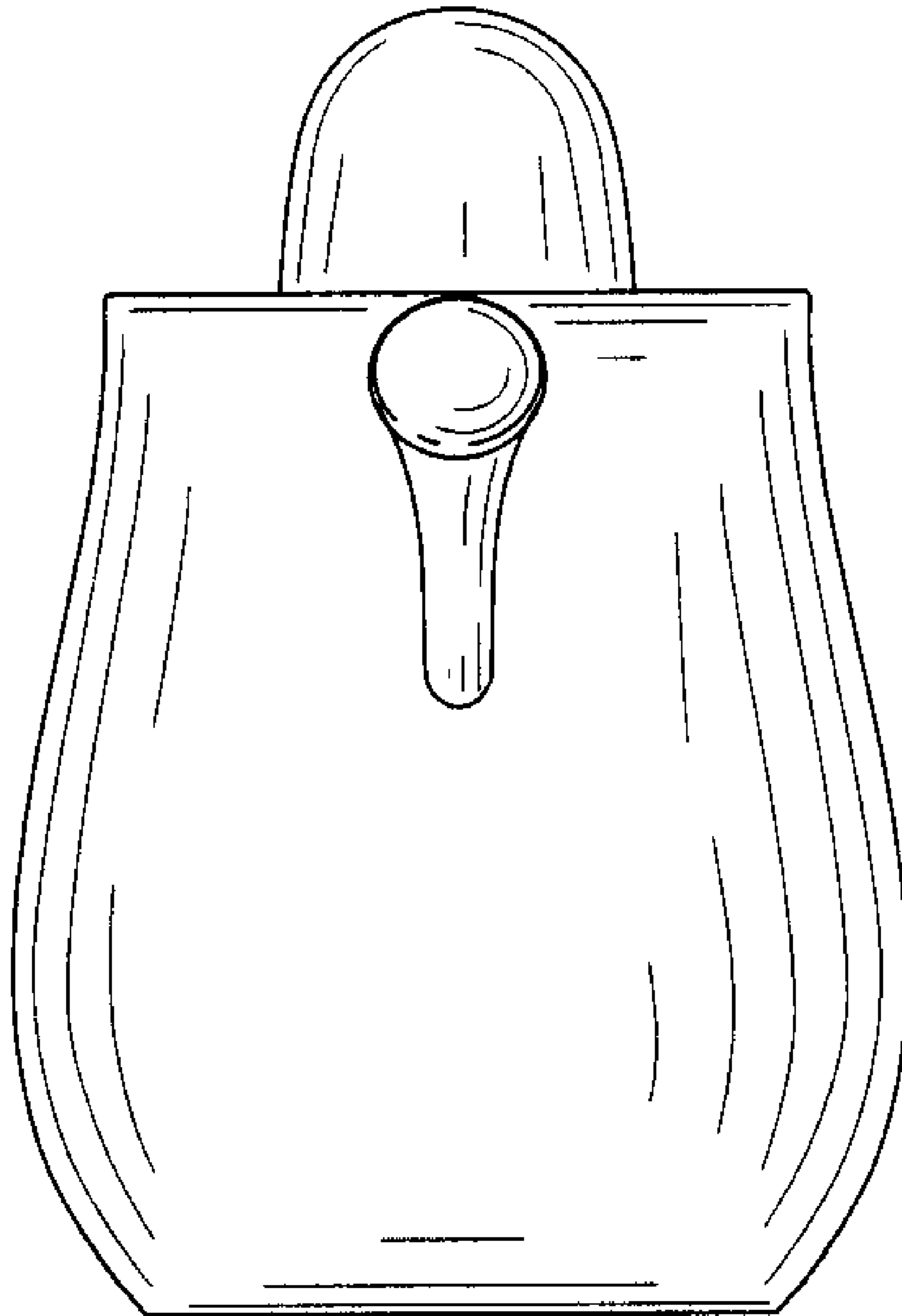

FIG. 3

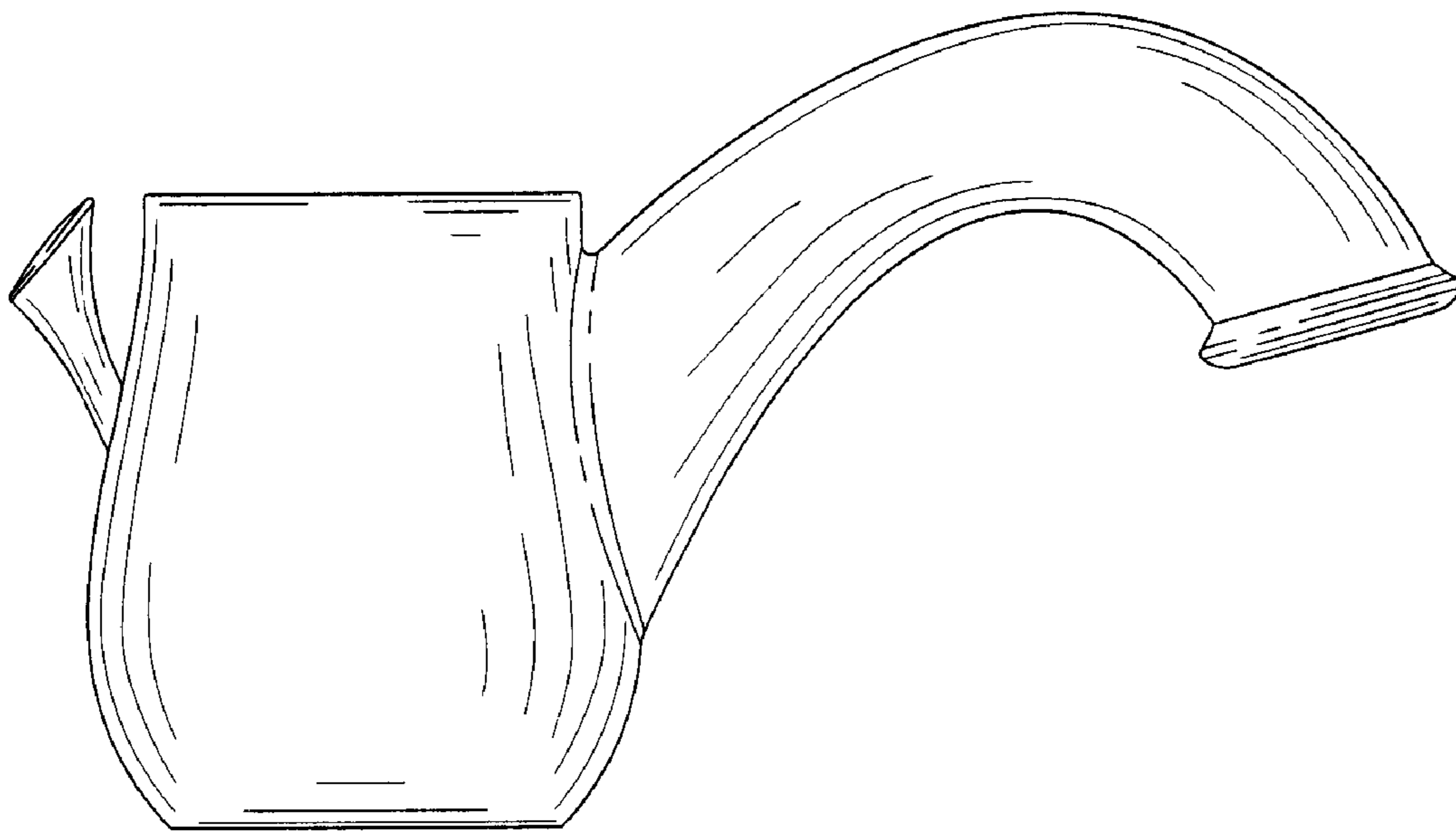

FIG. 4

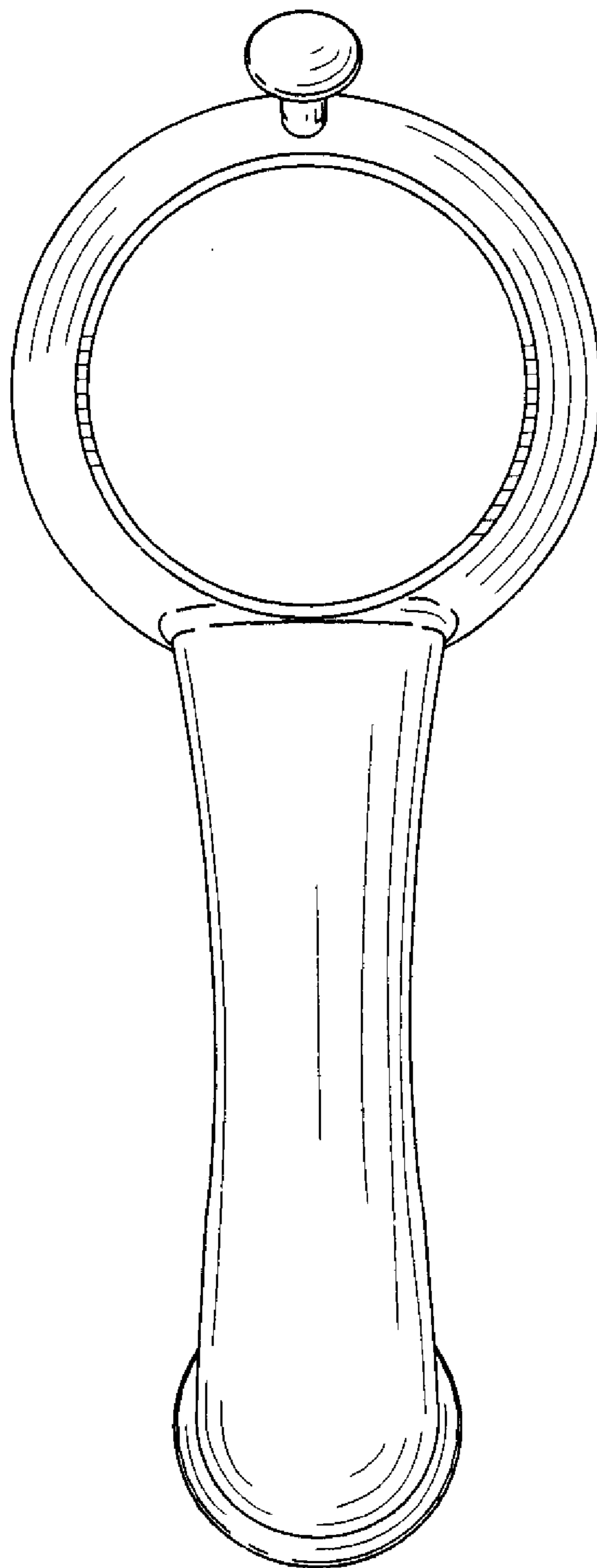

FIG. 5

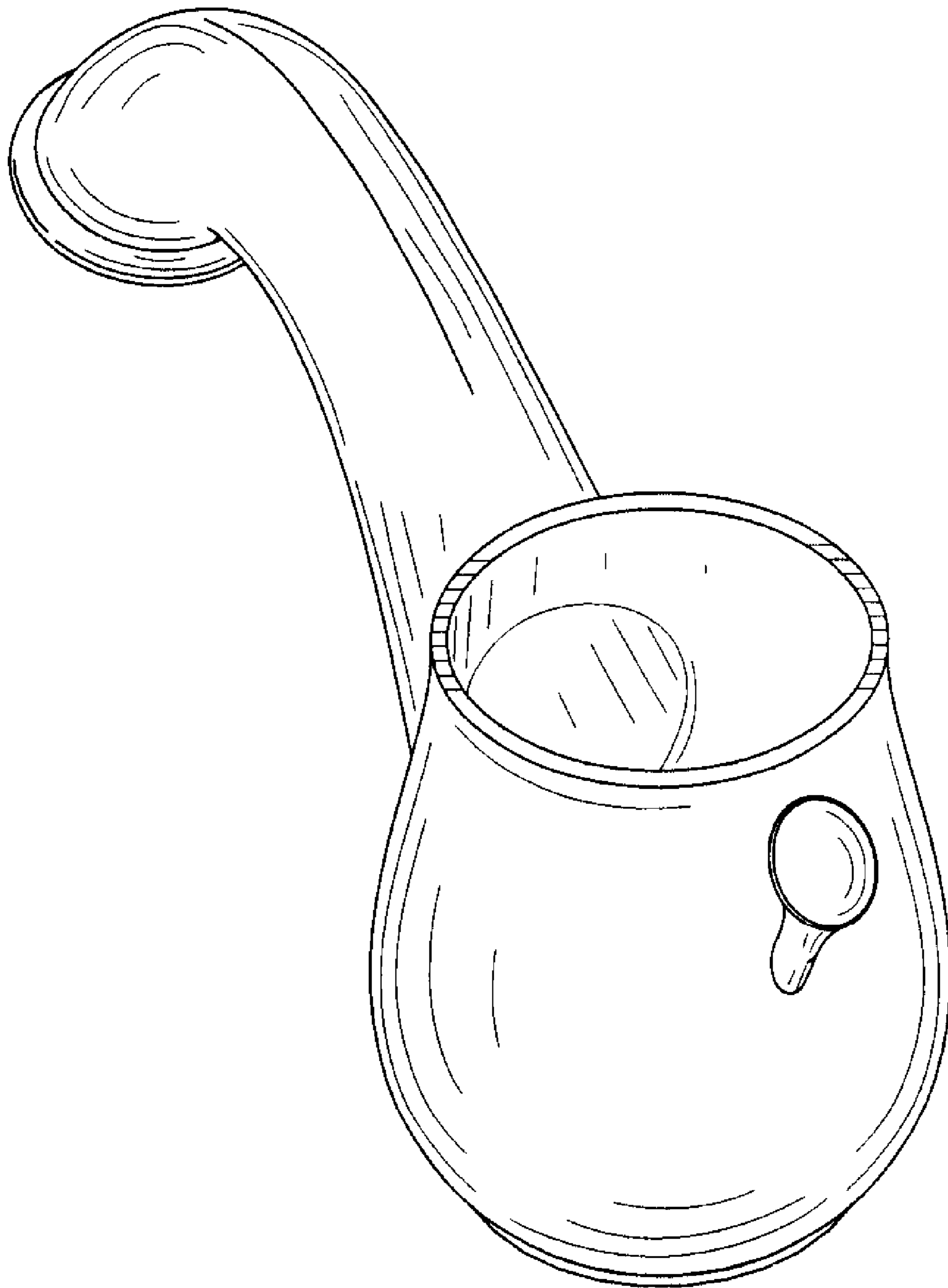

FIG. 6