

US00D525608S

(12) **United States Design Patent** (10) **Patent No.:** **US D525,608 S**  
**Ryu** (45) **Date of Patent:** **\*\* Jul. 25, 2006**

(54) **PORTABLE RADIOTELEPHONE**

(75) Inventor: **Yong Sun Ryu**, Seoul (KR)

(73) Assignee: **VK Corporation** (KR)

(\*\*) Term: **14 Years**

(21) Appl. No.: **29/219,942**

(22) Filed: **Dec. 22, 2004**

(30) **Foreign Application Priority Data**

Jun. 28, 2004 (KR) ..... 30-2004-0019303

(51) **LOC (8) Cl.** ..... **14-03**

(52) **U.S. Cl.** ..... **D14/138**

(58) **Field of Classification Search** ..... D14/137,  
D14/138, 147-148, 247-248, 144, 341-347;  
379/433.01-433.13; 455/575.4, 566, 575.1,  
455/556.1, 556.2, 90.3

See application file for complete search history.

(56) **References Cited**

**U.S. PATENT DOCUMENTS**

D466,096 S	*	11/2002	Takada	.....	D14/138
D479,215 S	*	9/2003	Yokoyama	.....	D14/138
D493,156 S	*	7/2004	Hamann et al.	.....	D14/138
6,822,871 B1	*	11/2004	Lee et al.	.....	361/727
D501,475 S	*	2/2005	Kim	.....	D14/346
D502,162 S	*	2/2005	Kim et al.	.....	D14/138
D502,454 S	*	3/2005	Lee	.....	D14/138
D503,164 S	*	3/2005	Park et al.	.....	D14/138
D503,699 S	*	4/2005	Lee et al.	.....	D14/138
D508,240 S	*	8/2005	Lee et al.	.....	D14/138
D508,473 S	*	8/2005	Lee et al.	.....	D14/138
D508,687 S	*	8/2005	Lee	.....	D14/138
D508,688 S	*	8/2005	Lee et al.	.....	D14/138

(Continued)

**OTHER PUBLICATIONS**

VK Mobile VK610 telephone, announced third quarter 2004, [online], [retrieved on Feb. 13, 2006]. Retrieved from the Internet ,<URL: <http://www.gsmarena.com>>.\*

VK Mobile VK900 telephone, announced fourth quarter 2004, [online], [retrieved on Feb. 14, 2006]. Retrieved from Internet ,<URL: <http://www.gsmarena.com>>.\*

Samsung D800 telephone, announced fourth quarter 2005, [online], [retrieved on Feb. 15, 2006]. Retrieved from Internet ,<URL: <http://www.gsmarena.com>>.\*

Samsung E350 telephone, announced first quarter 2005, [online], [retrieved on Feb. 14, 2006]. Retrieved from Internet ,<URL: <http://www.gsmarena.com>>.\*

Samsung Z320i telephone, announced fourth quarter 2005, [online], [retrieved on Feb. 17, 2006]. Retrieved from Internet ,<URL: <http://www.gsmarena.com>>.\*

Samsung D820 telephone, announced fourth quarter 2005, [online], [retrieved on Feb. 15, 2006]. Retrieved from Internet ,<URL: <http://www.gsmarena.com>>.\*

Samsung D600 telephone, announced first quarter 2005, [online], [retrieved on Feb. 14, 2006]. Retrieved from Internet ,<URL: <http://www.gsmarena.com>>.\*

*Primary Examiner*—Jeffrey Asch

(57) **CLAIM**

The ornamental design for a portable radiotelephone, as shown.

**DESCRIPTION**

FIG. 1 is a front perspective view of a portable radiotelephone according to the invention;

FIG. 2 is a front view of a portable radiotelephone according to the invention;

FIG. 3 is a rear view of a portable radiotelephone according to the invention;

FIG. 4 is a left side view of a portable radiotelephone according to the invention;

FIG. 5 is a right side view of a portable radiotelephone according to the invention;

FIG. 6 is a top view of a portable radiotelephone according to the invention;

FIG. 7 is a bottom view of a portable radiotelephone according to the invention; and,

FIG. 8 is a front view of a portable radiotelephone according to the invention in an open position.

**1 Claim, 8 Drawing Sheets**

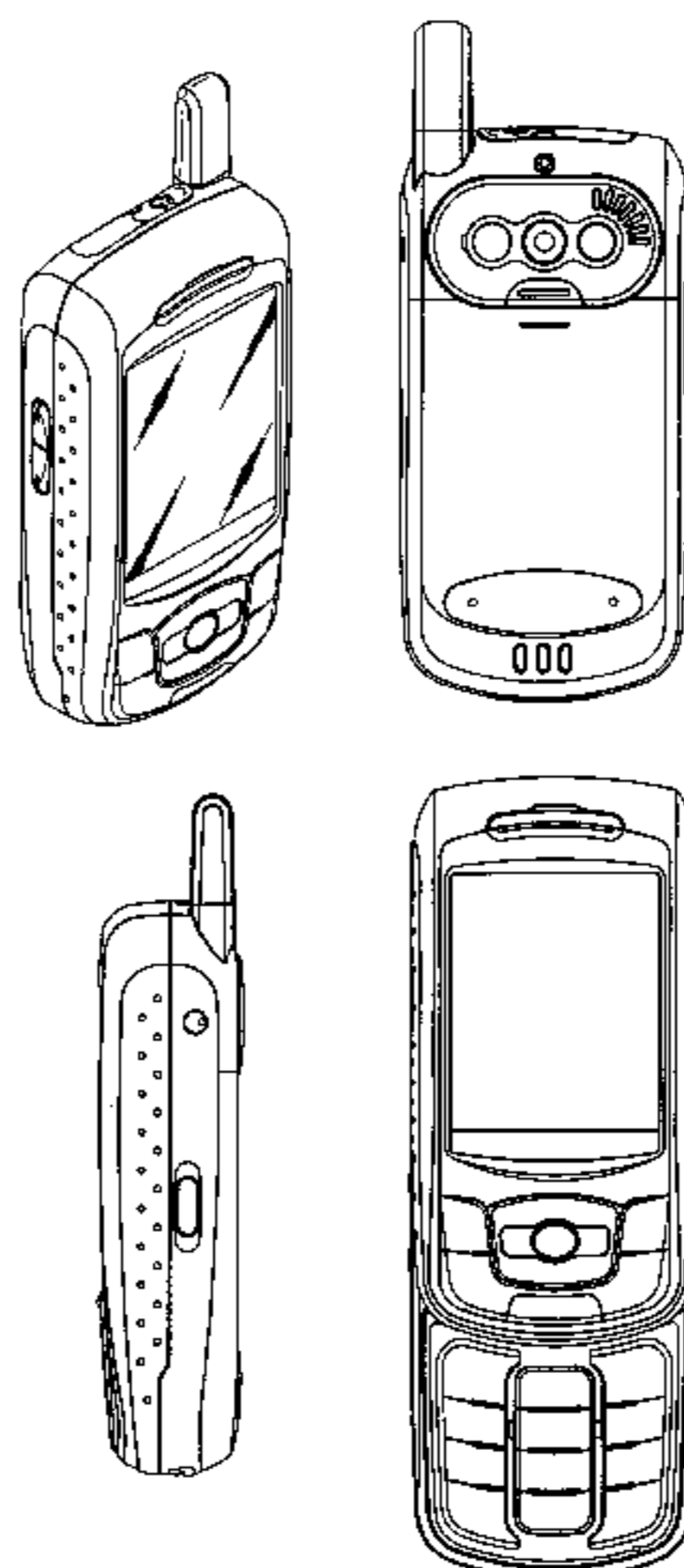

# US D525,608 S

Page 2

---

## U.S. PATENT DOCUMENTS

D509,202 S *	9/2005	Lee et al. ....	D14/138	2005/0090298 A1 *	4/2005	Park et al. ....	455/575.4
D509,204 S *	9/2005	Michler .....	D14/138	2005/0107126 A1 *	5/2005	Kim .....	455/565
D509,206 S *	9/2005	Jang .....	D14/138	2005/0124394 A1 *	6/2005	Kim et al. ....	455/575.3
D509,215 S *	9/2005	Han et al. ....	D14/343	2005/0233708 A1 *	10/2005	Im et al. ....	455/90.3
D512,702 S *	12/2005	Lee et al. ....	D14/138	2005/0245297 A1 *	11/2005	Lee et al. ....	455/575.4
D515,060 S *	2/2006	Lee et al. ....	D14/138	2005/0250532 A1 *	11/2005	Hwang et al. ....	455/550.1
2004/0259592 A1 *	12/2004	Taneyya et al. ....	455/556.1	2005/0266897 A1 *	12/2005	Ahn et al. ....	455/575.1
2005/0009581 A1 *	1/2005	Im et al. ....	455/575.4				

\* cited by examiner

FIG. 1

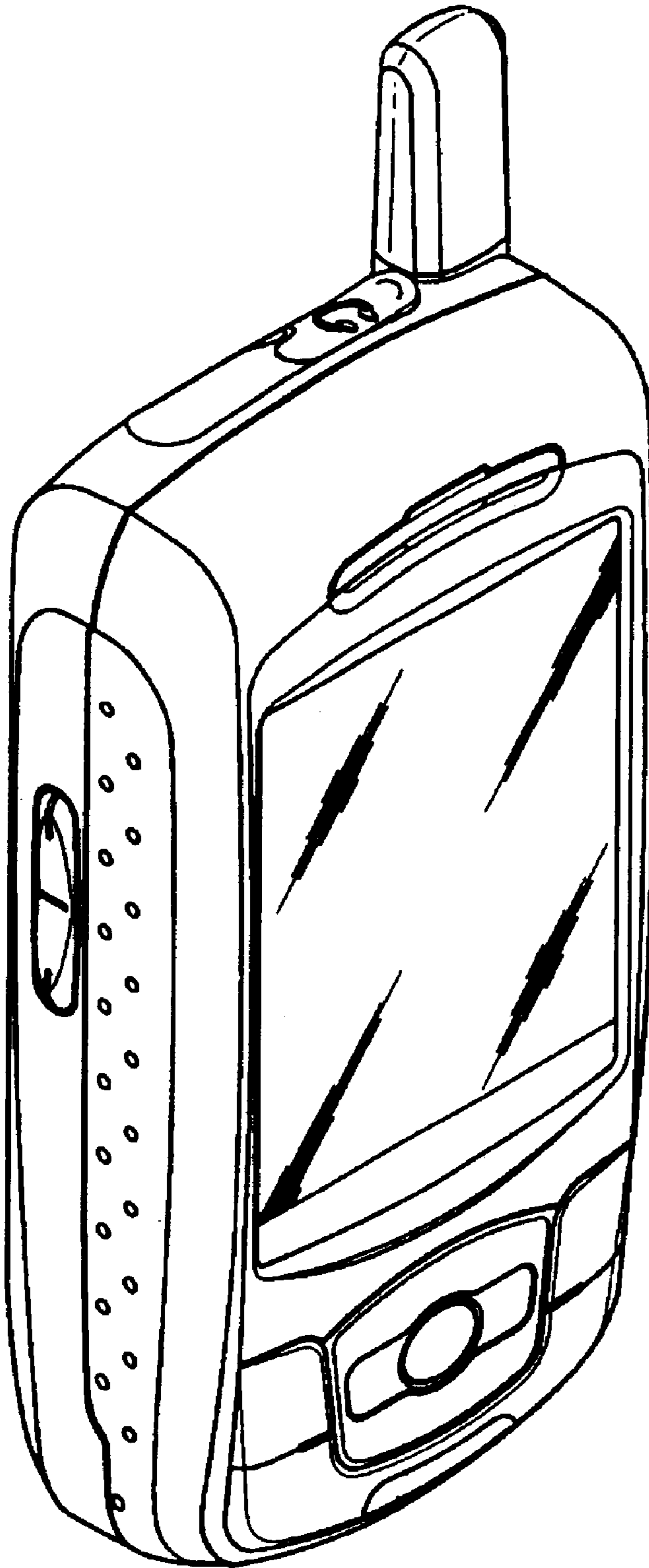

FIG. 2

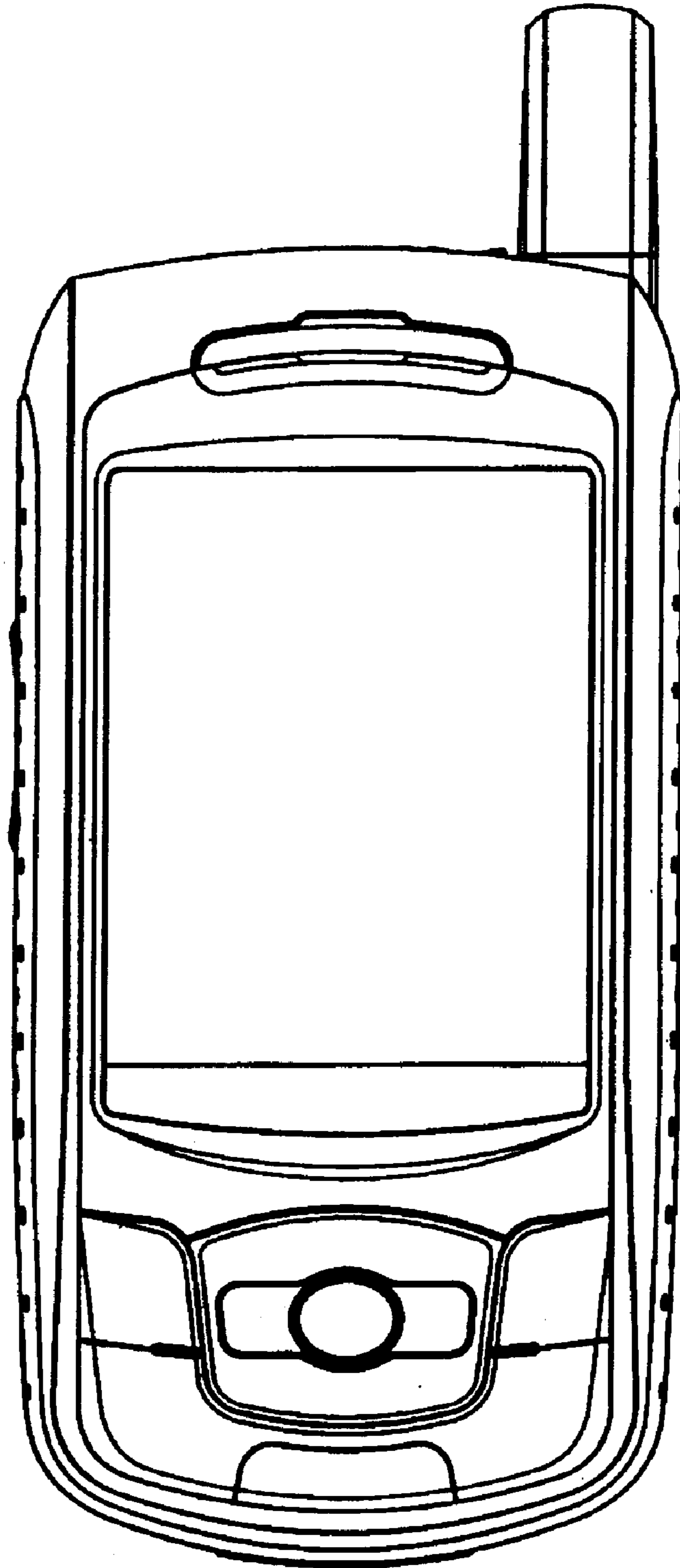

FIG. 3

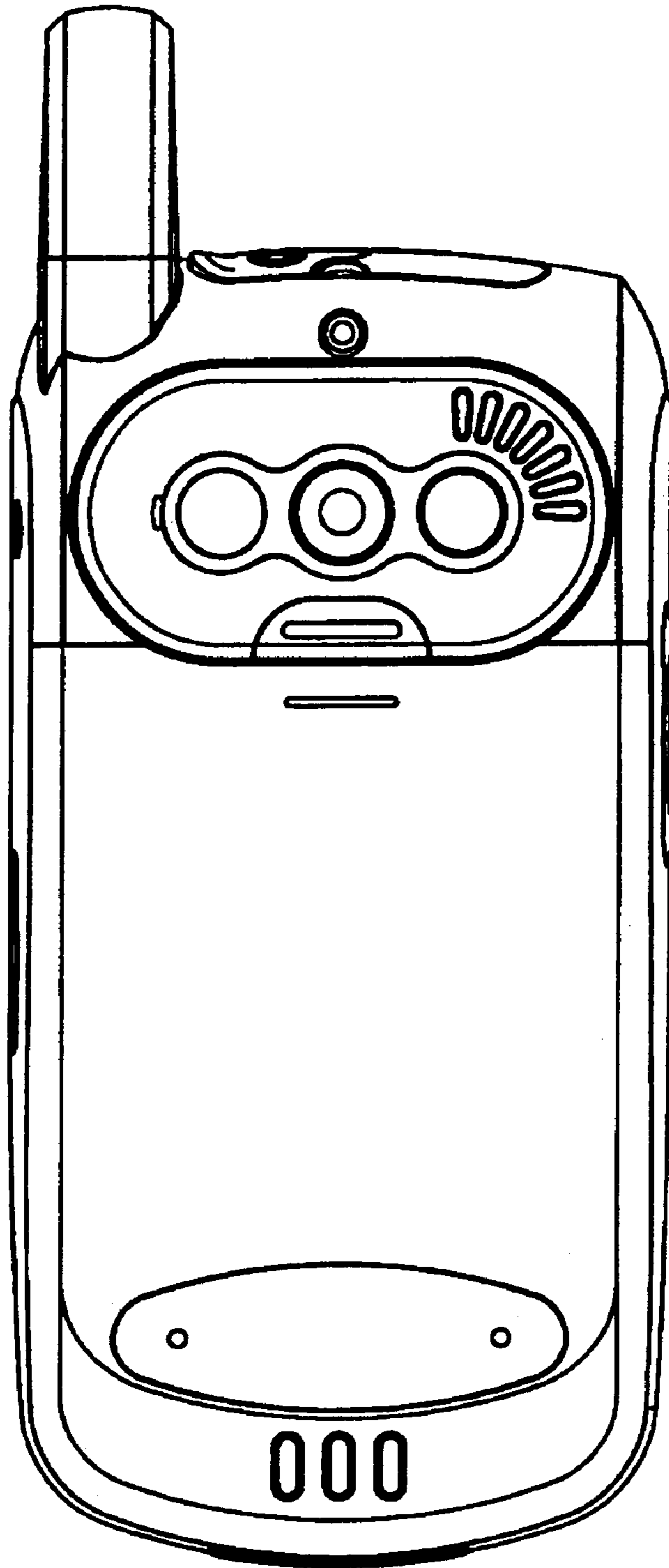

FIG. 4

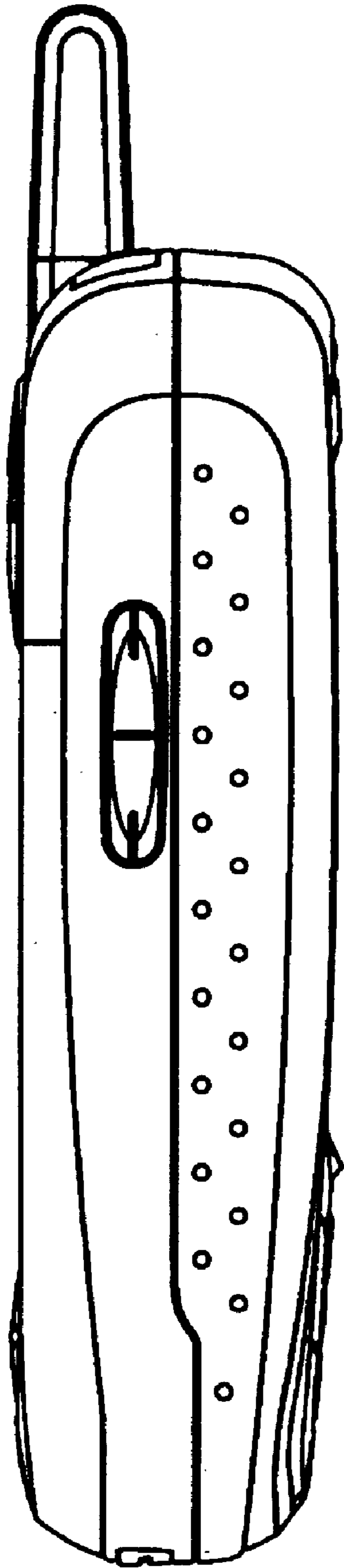
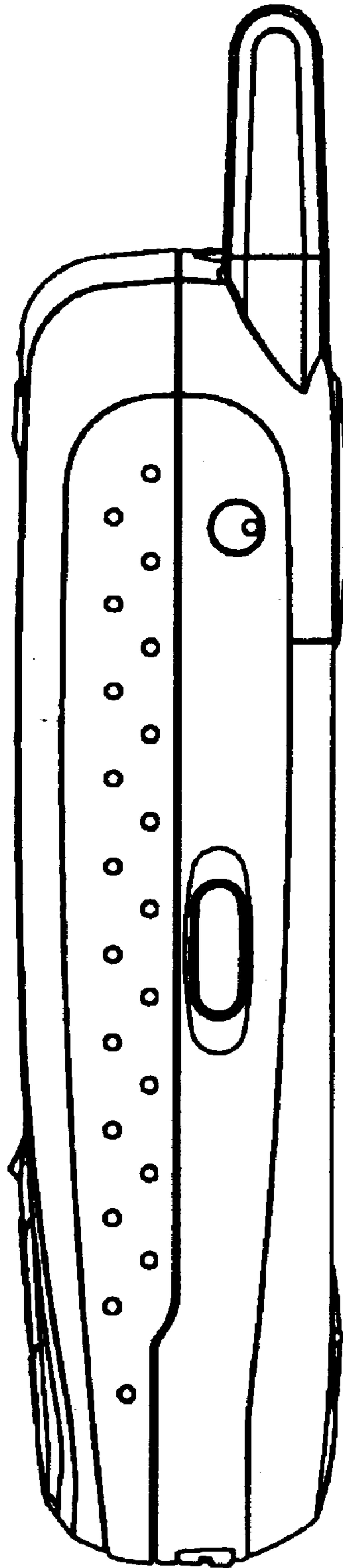

FIG. 5



**FIG. 6**

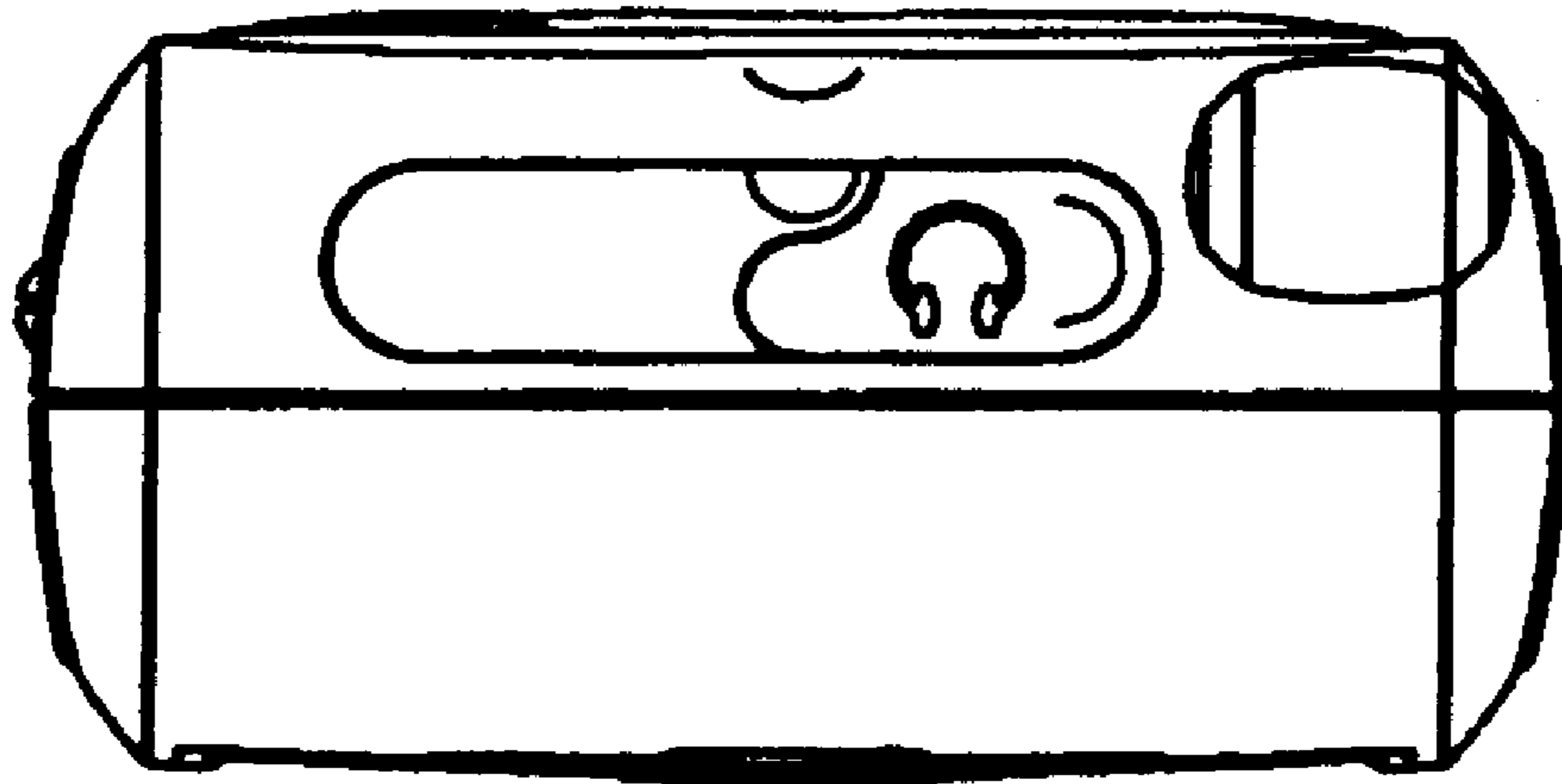



FIG. 7

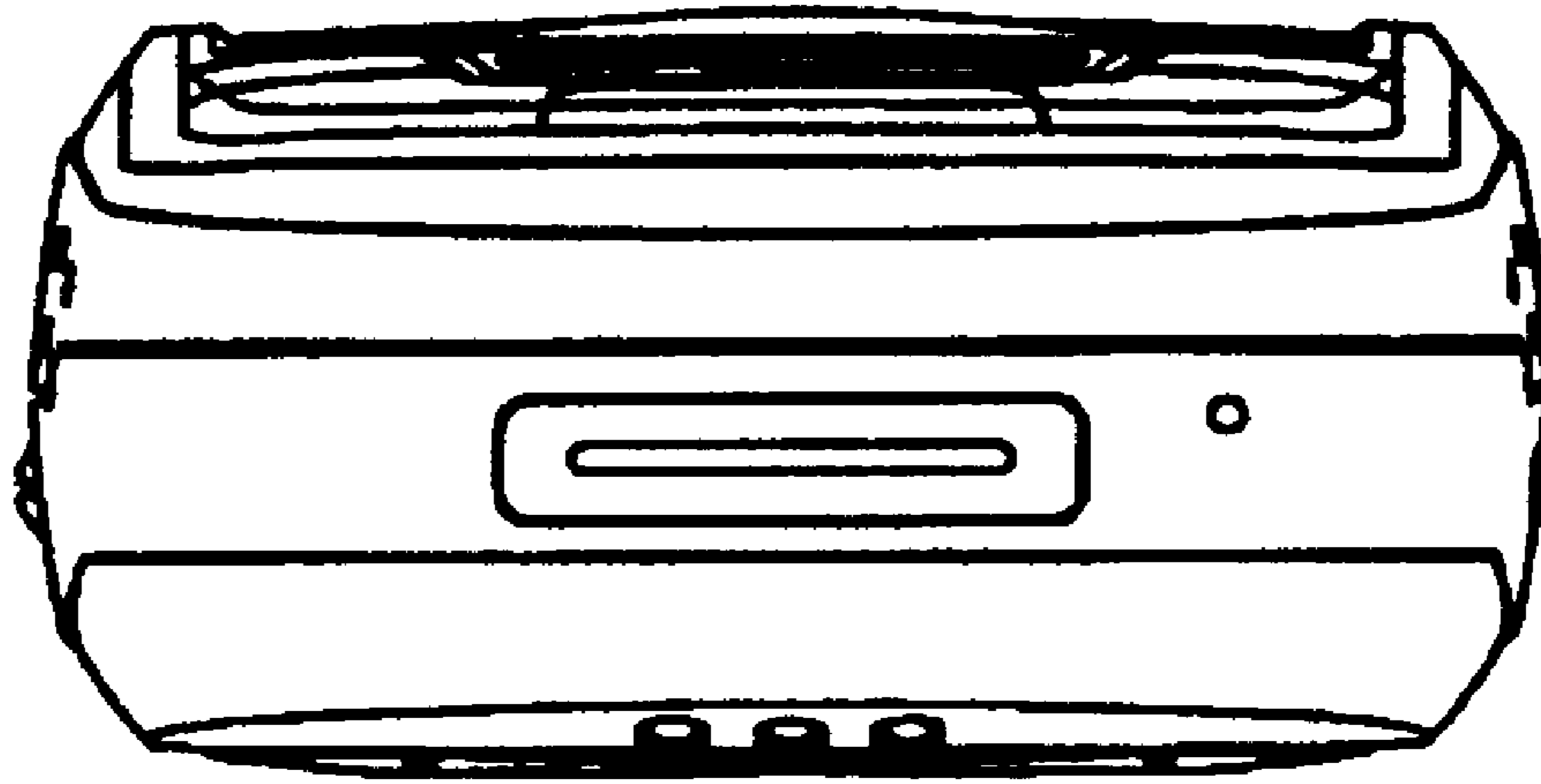

FIG. 8

