

US00D525597S

(12) **United States Design Patent**  
**Lin**

(10) **Patent No.:** **US D525,597 S**  
(45) **Date of Patent:** **\*\* Jul. 25, 2006**

(54) **TELEVISION SET**

(75) Inventor: **Roger Lin**, Taipei (TW)

(73) Assignee: **Hannspree, Inc.**, Taipei (TW)

(\*\*) Term: **14 Years**

(21) Appl. No.: **29/231,592**

(22) Filed: **Jun. 8, 2005**

(30) **Foreign Application Priority Data**

Dec. 10, 2004 (TW) ..... 93307564

(51) **LOC (8) Cl.** ..... **14-03**

(52) **U.S. Cl.** ..... **D14/126**

(58) **Field of Classification Search** ..... D14/125-134,  
D14/239, 371, 136, 374-377; 312/7.2; 348/836,  
348/838, 180, 184, 325, 739; 341/12; 248/917-924,  
248/465; 345/104, 133, 156, 168, 87, 173;  
720/605, 669, 600, 655; 369/99, 197; 455/344-347  
See application file for complete search history.

(56) **References Cited**

**U.S. PATENT DOCUMENTS**

D462,074 S \* 8/2002 Kim ..... D14/375

D473,867 S \* 4/2003 Lin ..... D14/371

D475,048 S \* 5/2003 Wu et al. .... D14/374  
D478,904 S \* 8/2003 Koo et al. .... D14/375  
D483,364 S \* 12/2003 Olson et al. .... D14/375  
D484,130 S \* 12/2003 Olson et al. .... D14/375  
D484,131 S \* 12/2003 Olson et al. .... D14/375  
D489,371 S \* 5/2004 Sarman ..... D14/371  
D491,901 S \* 6/2004 Chin et al. .... D14/134  
D502,452 S \* 3/2005 Peng ..... D14/126

\* cited by examiner

*Primary Examiner*—Raphael Barkai

(74) *Attorney, Agent, or Firm*—Troxell Law Office, PLLC

(57) **CLAIM**

The ornamental design for a television set, as shown and described.

**DESCRIPTION**

FIG. 1 is a perspective view of television set showing my design;  
FIG. 2 is front view thereof;  
FIG. 3 is a rear view thereof;  
FIG. 4 is a left side view thereof;  
FIG. 5 is a right side view thereof;  
FIG. 6 is a top view thereof; and,  
FIG. 7 is a bottom view thereof.

**1 Claim, 4 Drawing Sheets**

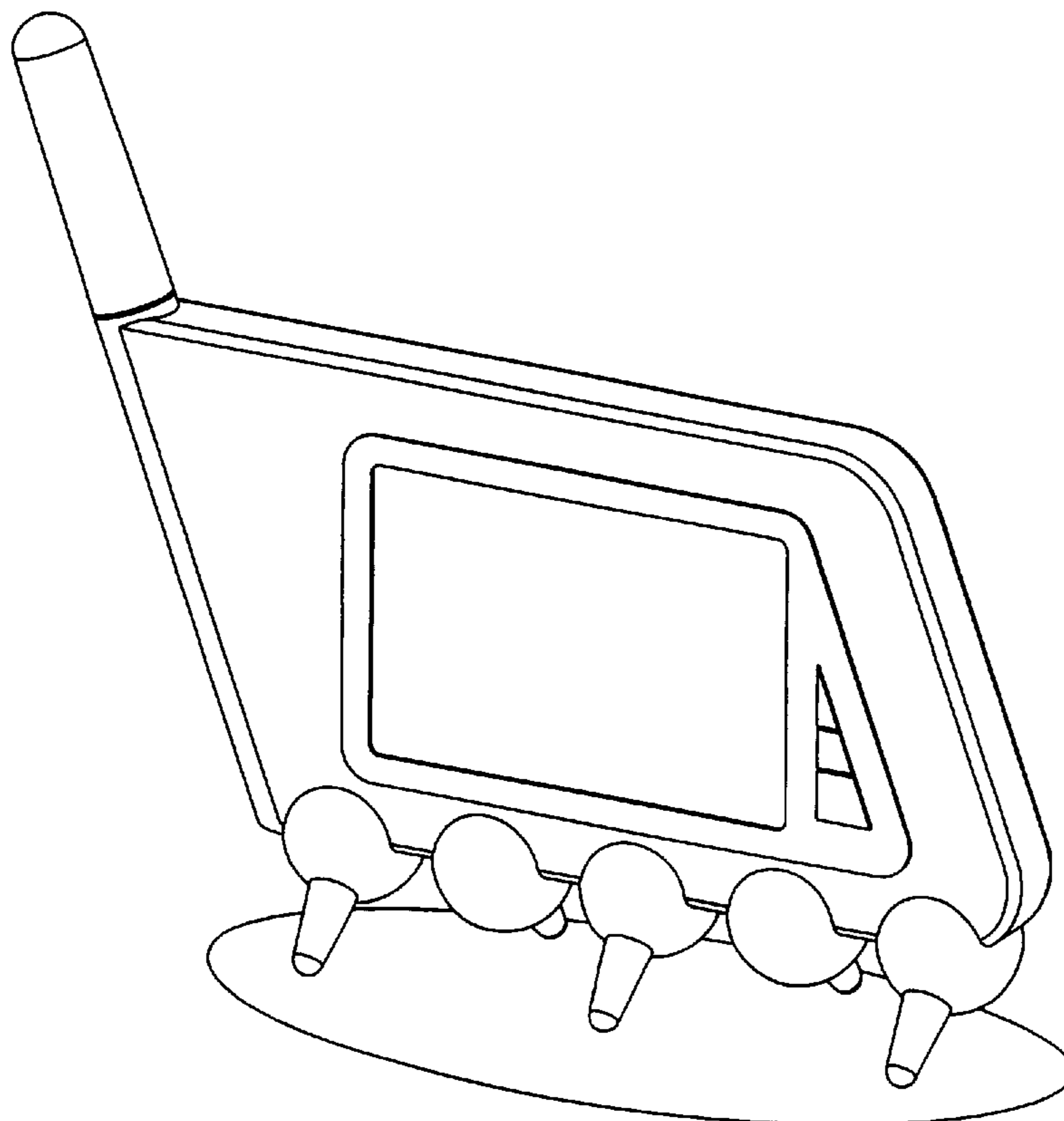

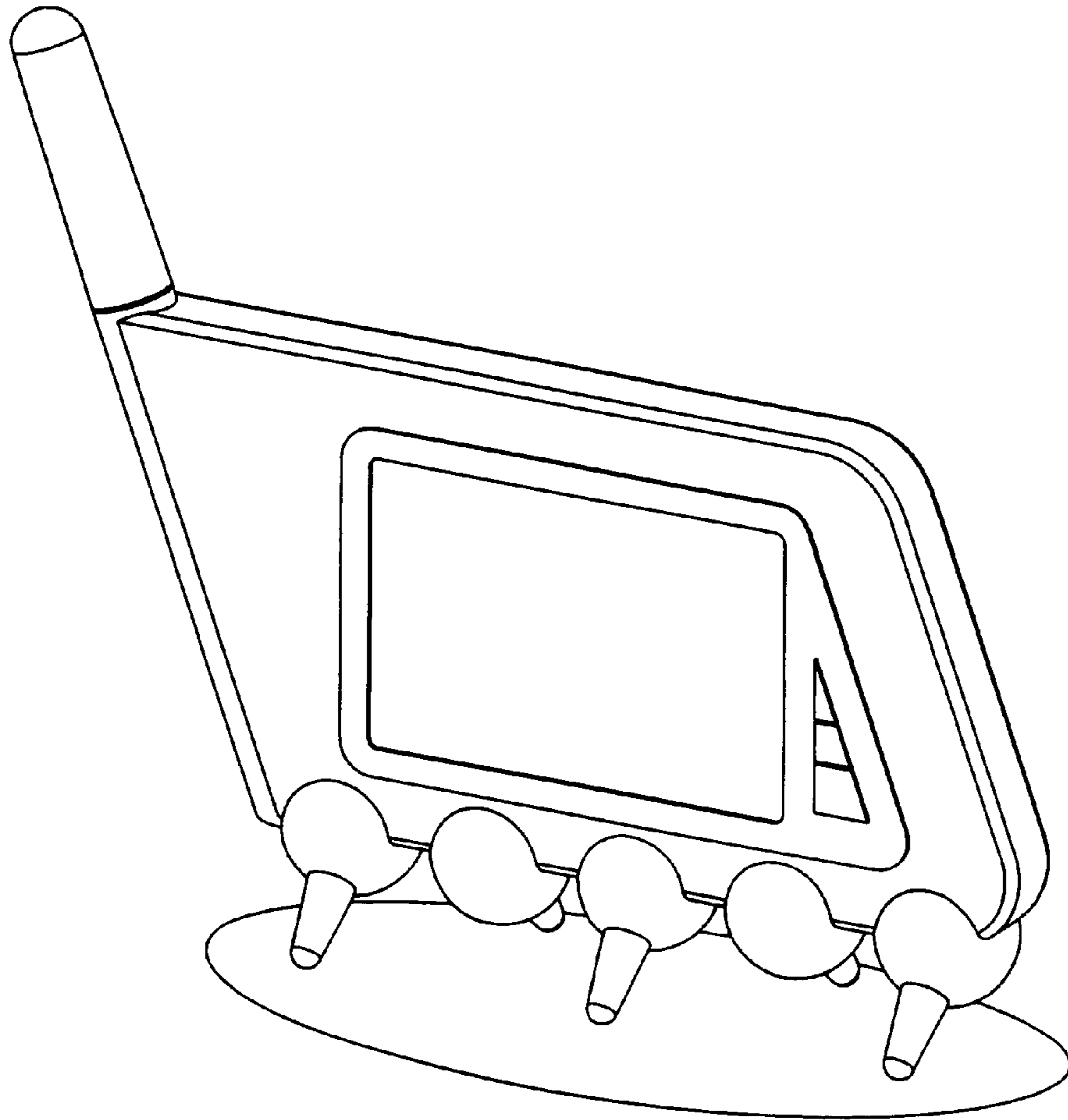

FIG. 1

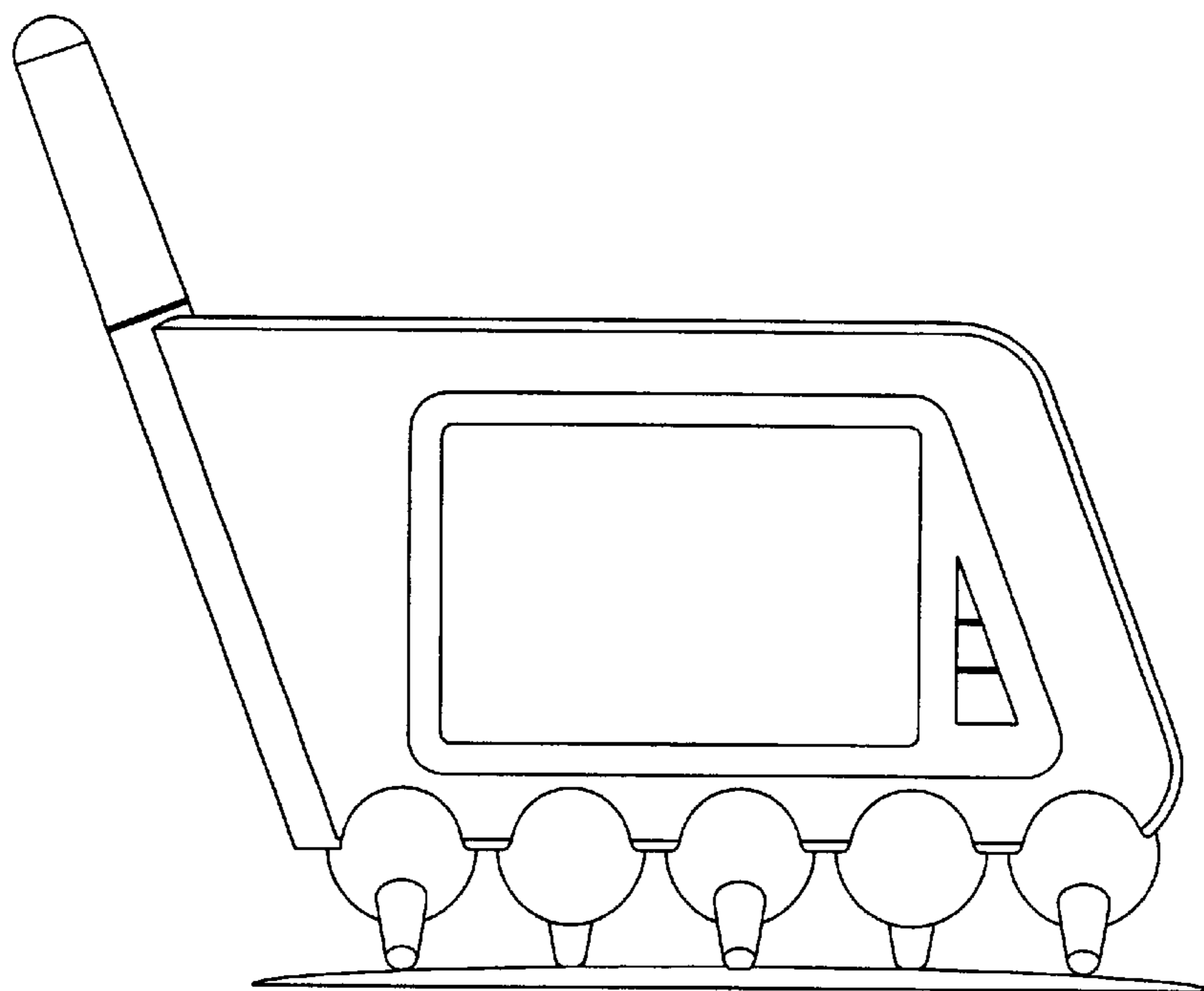

FIG. 2

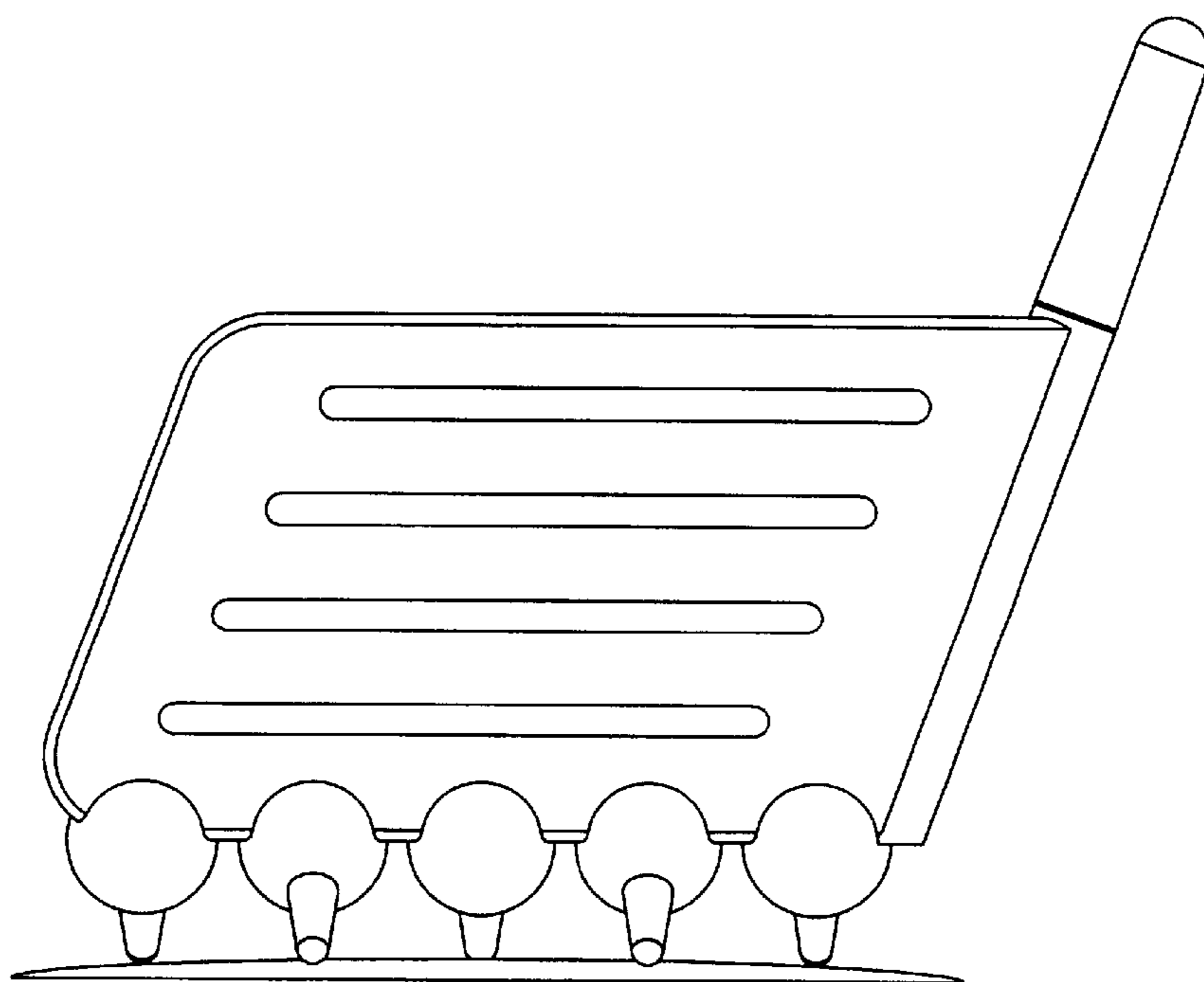

FIG. 3

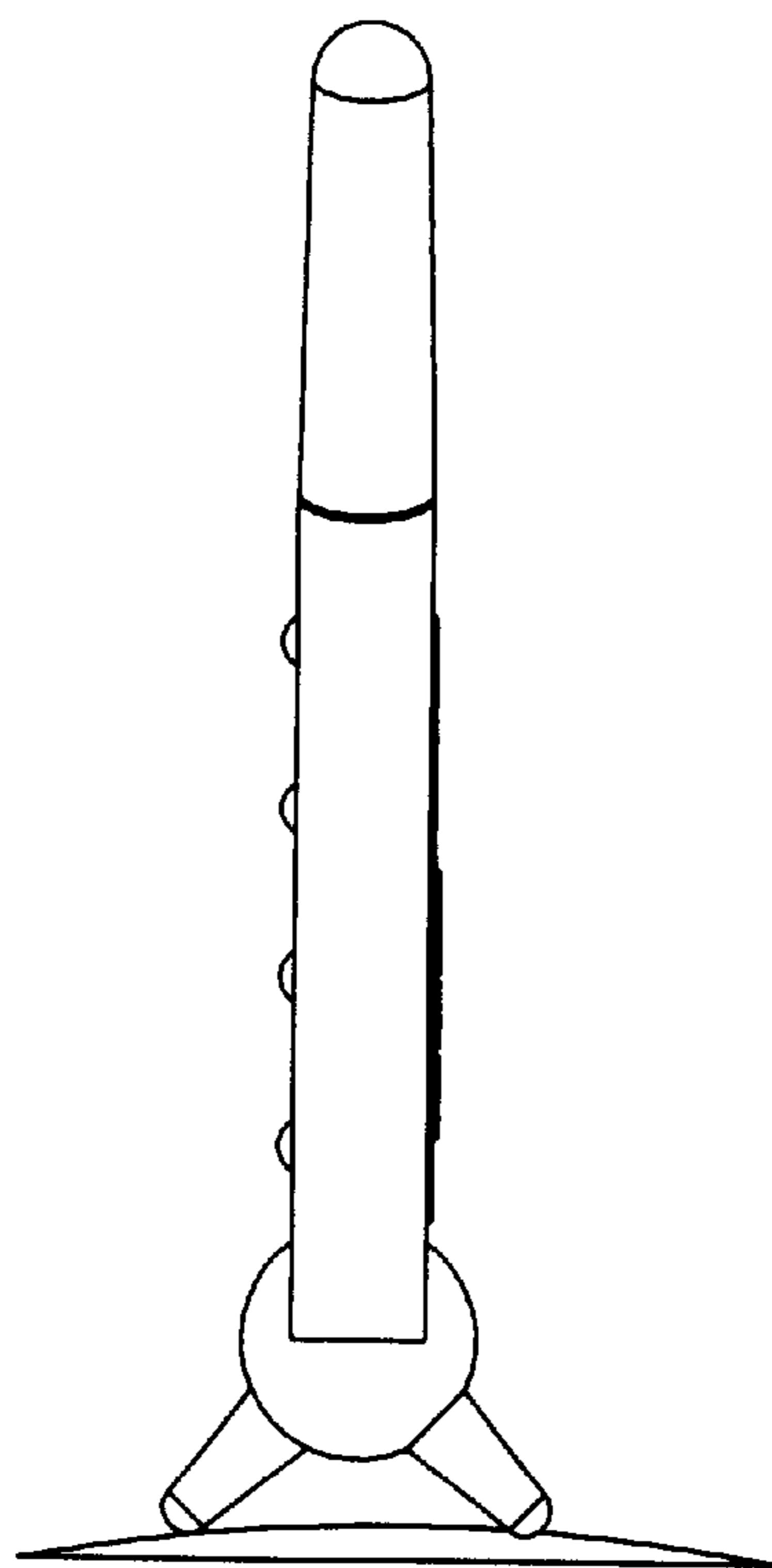

FIG. 4

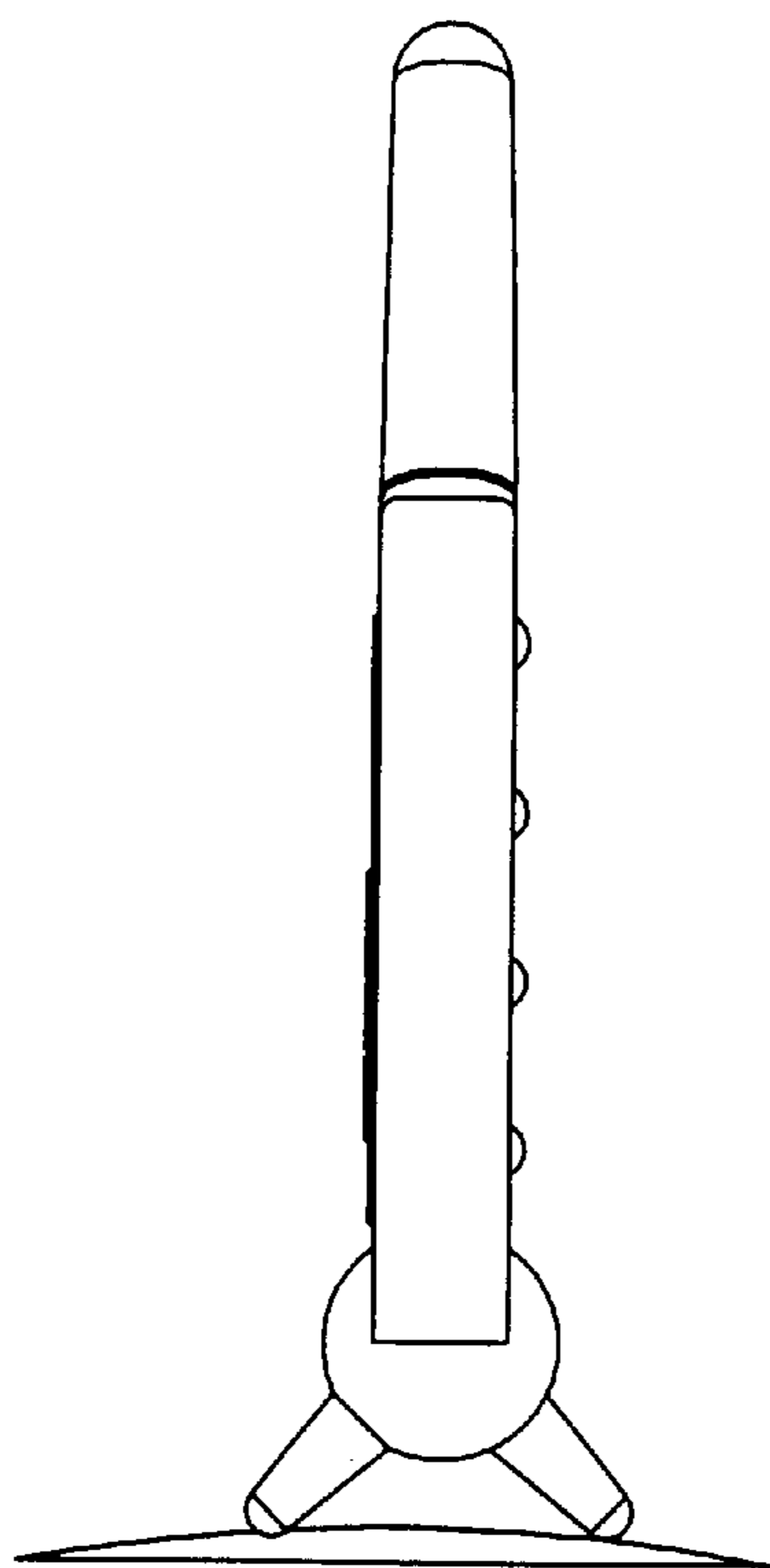

FIG. 5

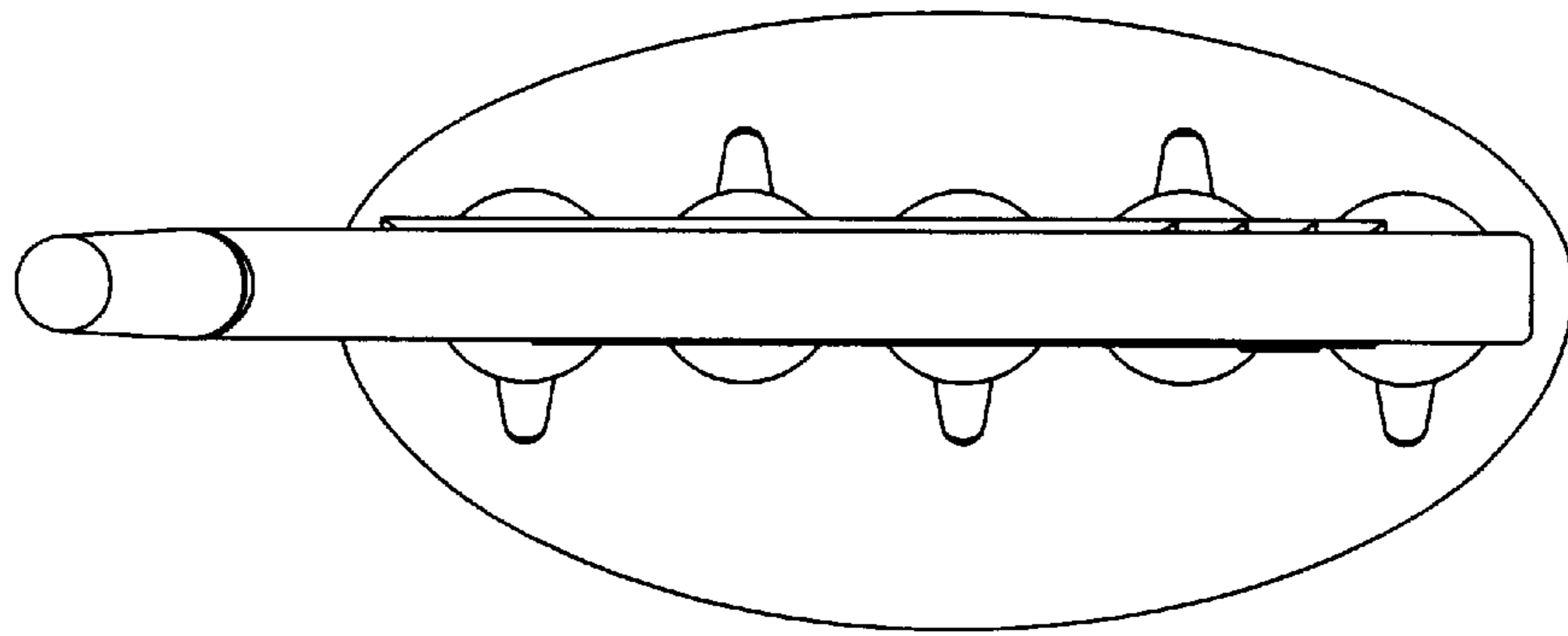

FIG. 6

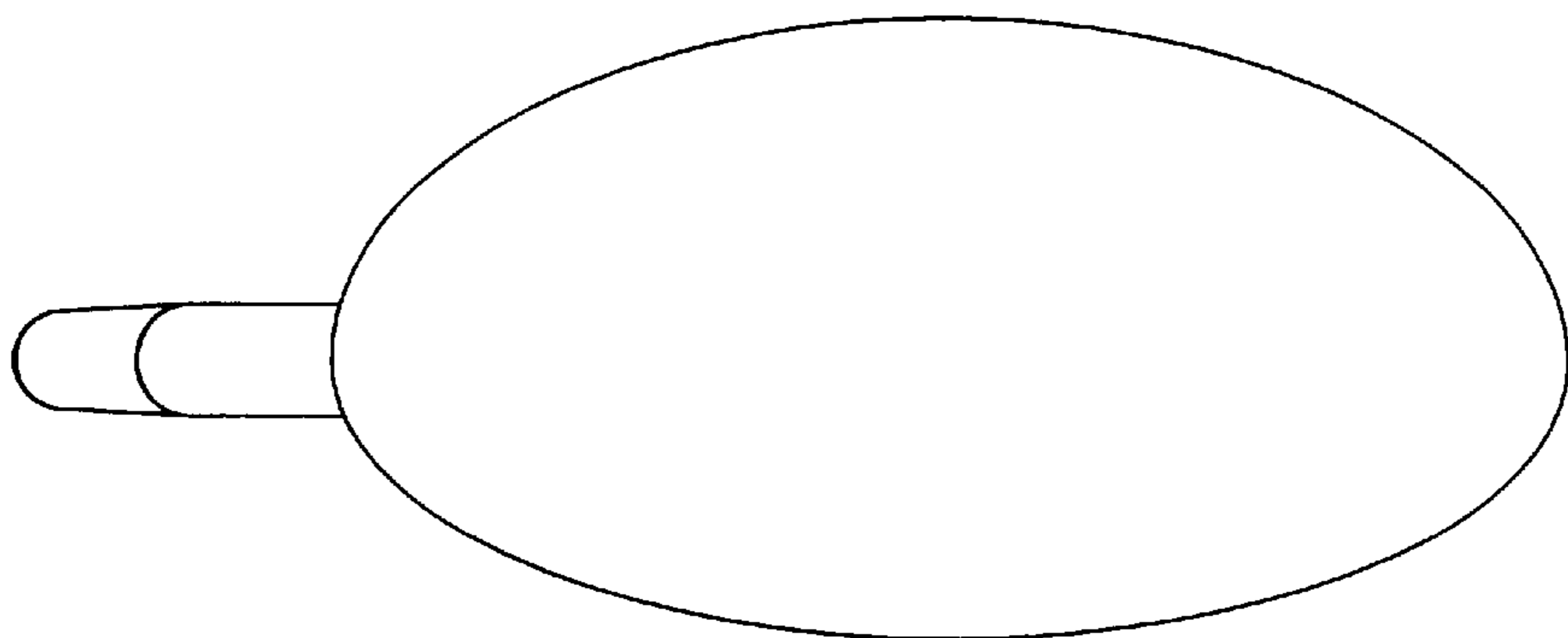

FIG. 7