



US00D525596S

(12) **United States Design Patent**
Imboden et al.

(10) **Patent No.:** **US D525,596 S**

(45) **Date of Patent:** **** Jul. 25, 2006**

(54) **TELEVISION SET**

(75) Inventors: **Ethan Imboden**, Sunnyvale, CA (US);
Timothy Roberts, Sunnyvale, CA (US)

(73) Assignee: **Hannspree, Inc.**, Taipei (TW)

(**) Term: **14 Years**

(21) Appl. No.: **29/230,640**

(22) Filed: **May 25, 2005**

(30) **Foreign Application Priority Data**

Dec. 10, 2004 (TW) 93307536

(51) **LOC (8) Cl.** **14-03**

(52) **U.S. Cl.** **D14/126**

(58) **Field of Classification Search** D14/125-134,
D14/239, 371, 136, 374-377; 312/7.2; 348/836,
348/838, 180, 184, 325, 739; 341/12; 248/917-924,
248/465; 345/104, 133, 156, 168, 87, 173;
720/605, 669, 600, 655; 369/99, 197; 455/344-347
See application file for complete search history.

(56) **References Cited**

U.S. PATENT DOCUMENTS

D410,907 S * 6/1999 Cavello D14/374

D419,538 S * 1/2000 Matsuoka et al. D14/376
D476,334 S * 6/2003 Koo et al. D14/375
D478,904 S * 8/2003 Koo et al. D14/375
D481,728 S * 11/2003 Olson et al. D14/375
D482,339 S * 11/2003 Yin et al. D14/134
D483,365 S * 12/2003 Olson et al. D14/375
D502,155 S * 2/2005 Sham D14/126

* cited by examiner

Primary Examiner—Raphael Barkai

(74) *Attorney, Agent, or Firm*—Troxell Law Office, PLLC

(57) **CLAIM**

The ornamental design for a television set, as shown and described.

DESCRIPTION

FIG. 1 is a perspective view of television set showing our design;
FIG. 2 is another rear side perspective view thereof;
FIG. 3 is a front view thereof;
FIG. 4 is a rear side view thereof;
FIG. 5 is a top view thereof;
FIG. 6 is a bottom view thereof;
FIG. 7 is a left side view thereof; and,
FIG. 8 is a right side view thereof.

1 Claim, 5 Drawing Sheets

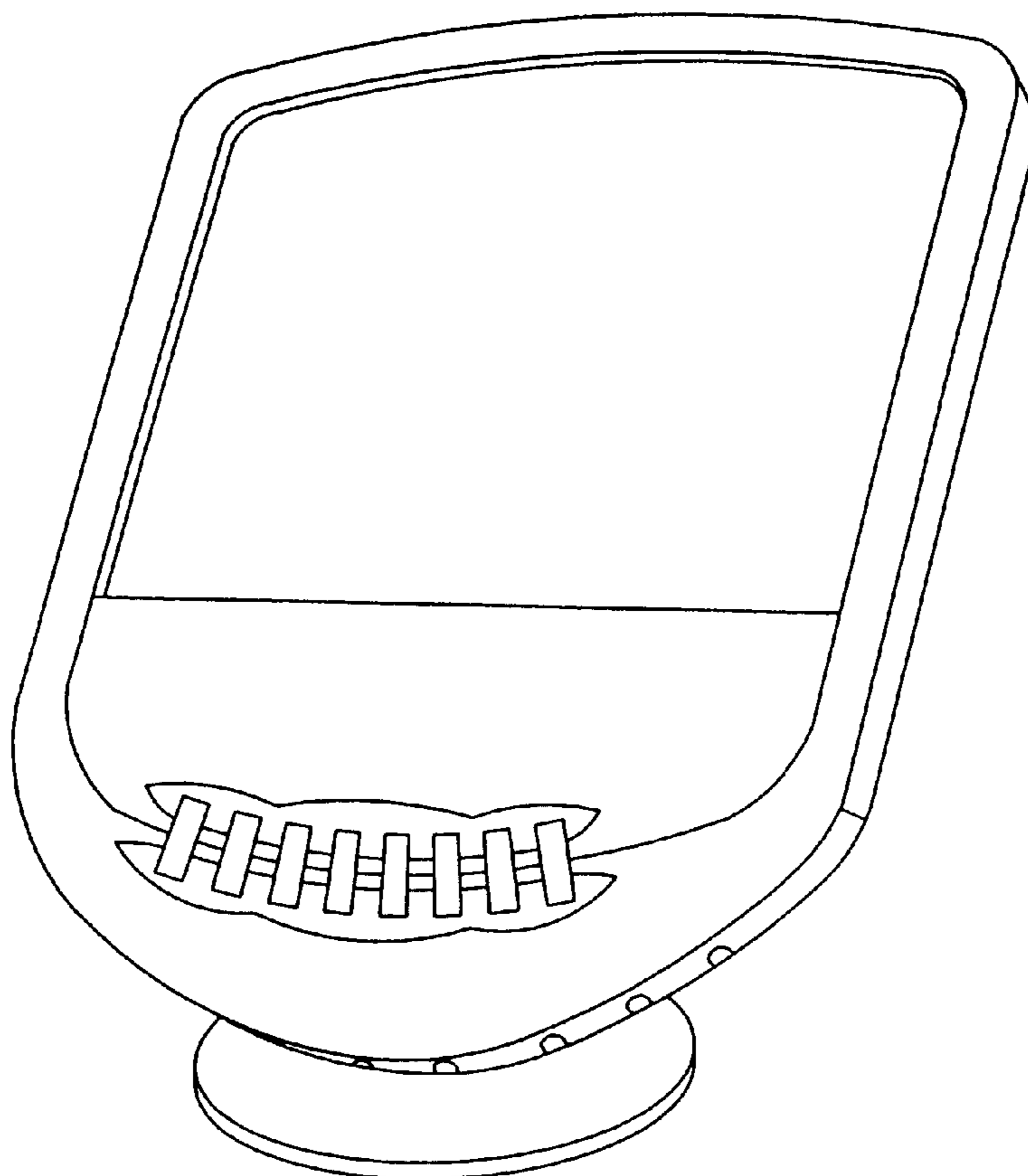

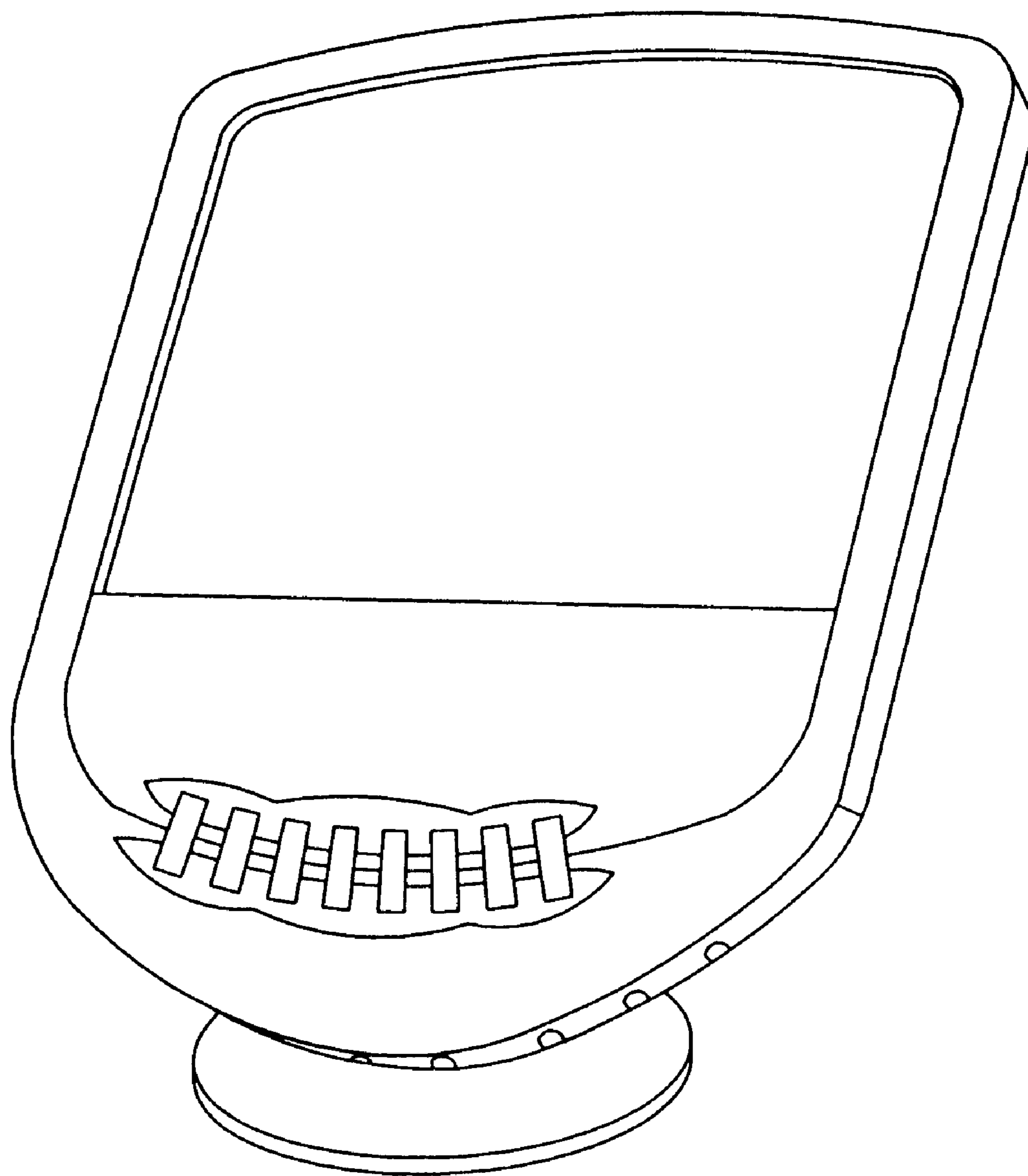

FIG. 1

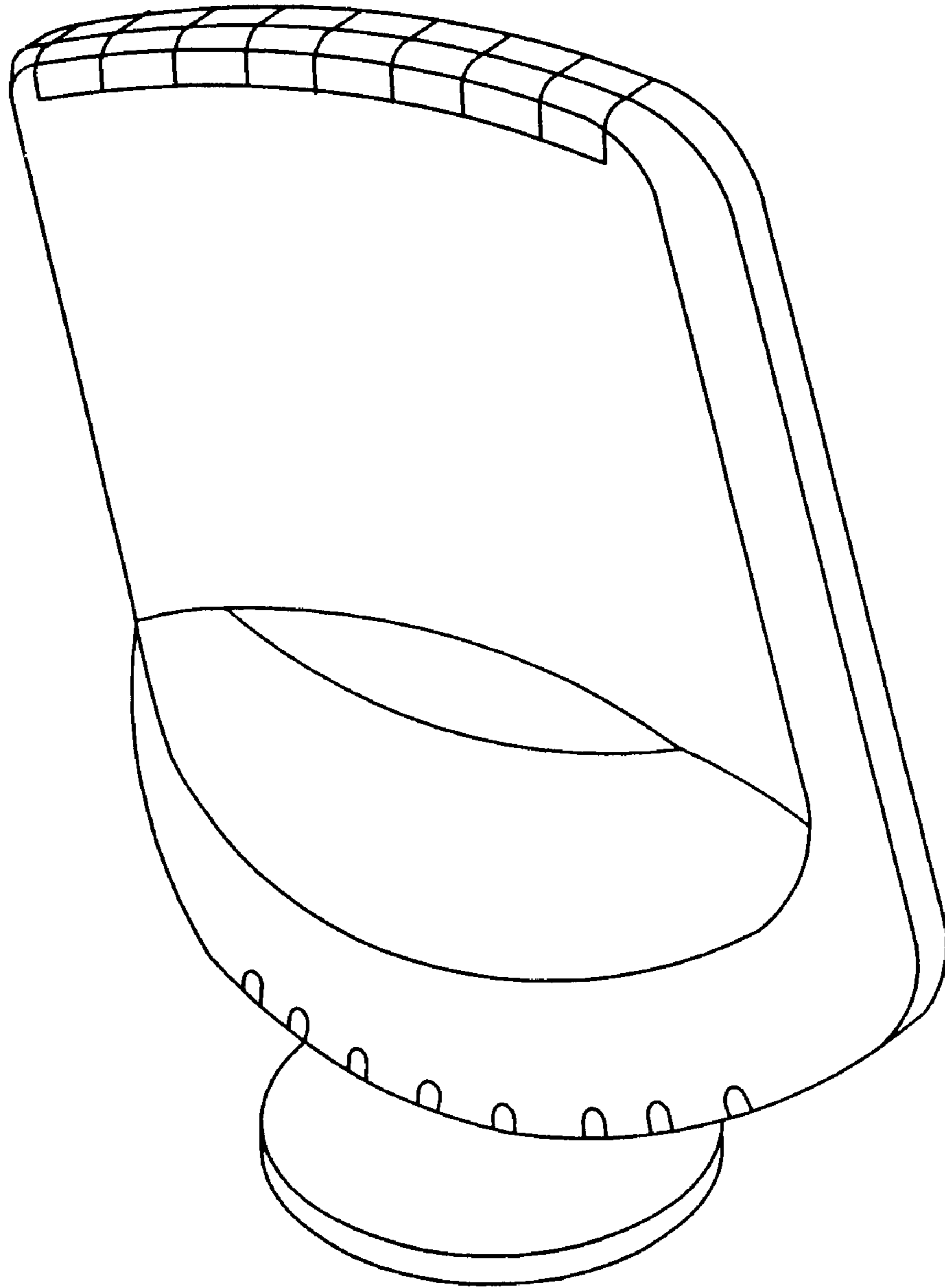

FIG. 2

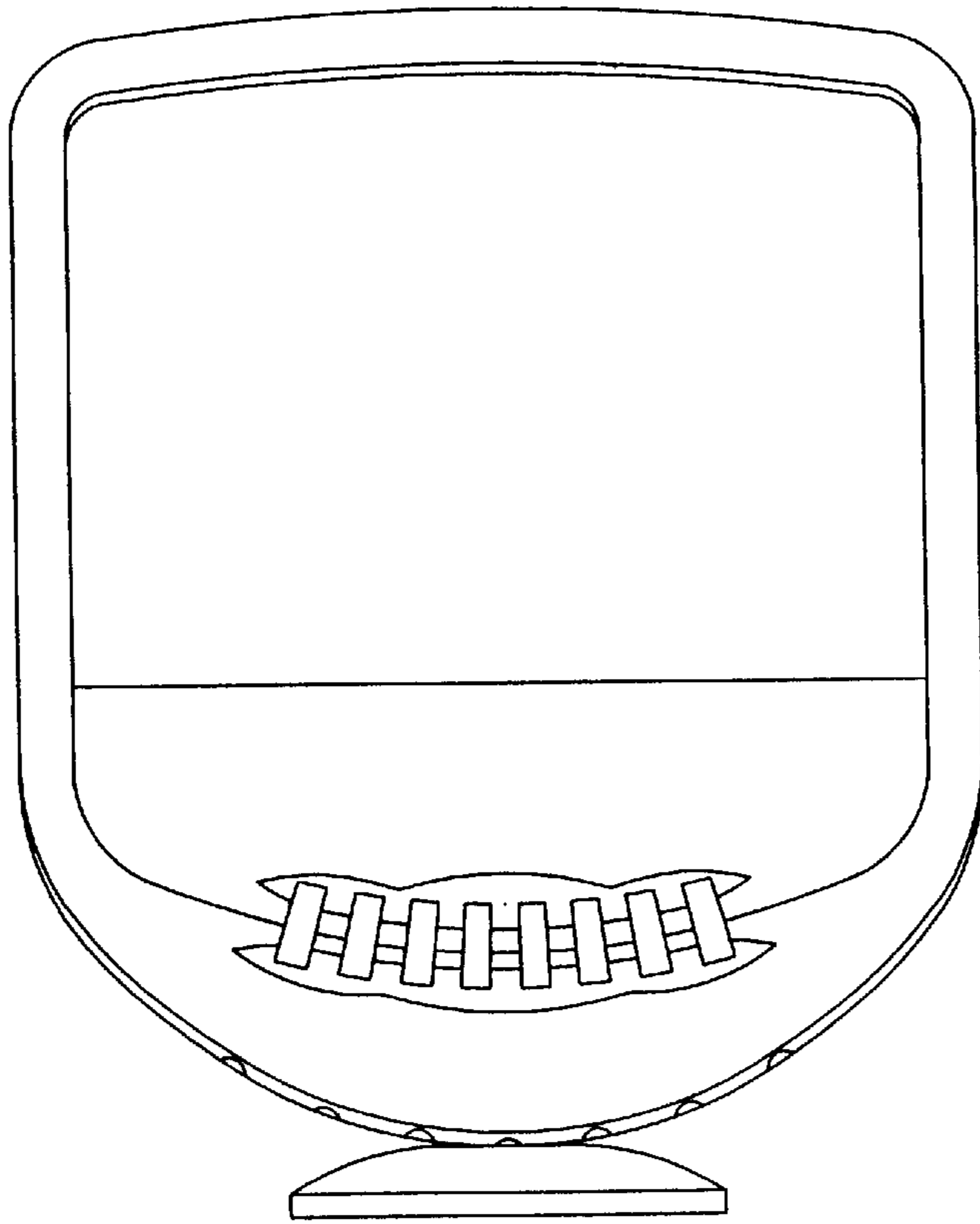

FIG. 3

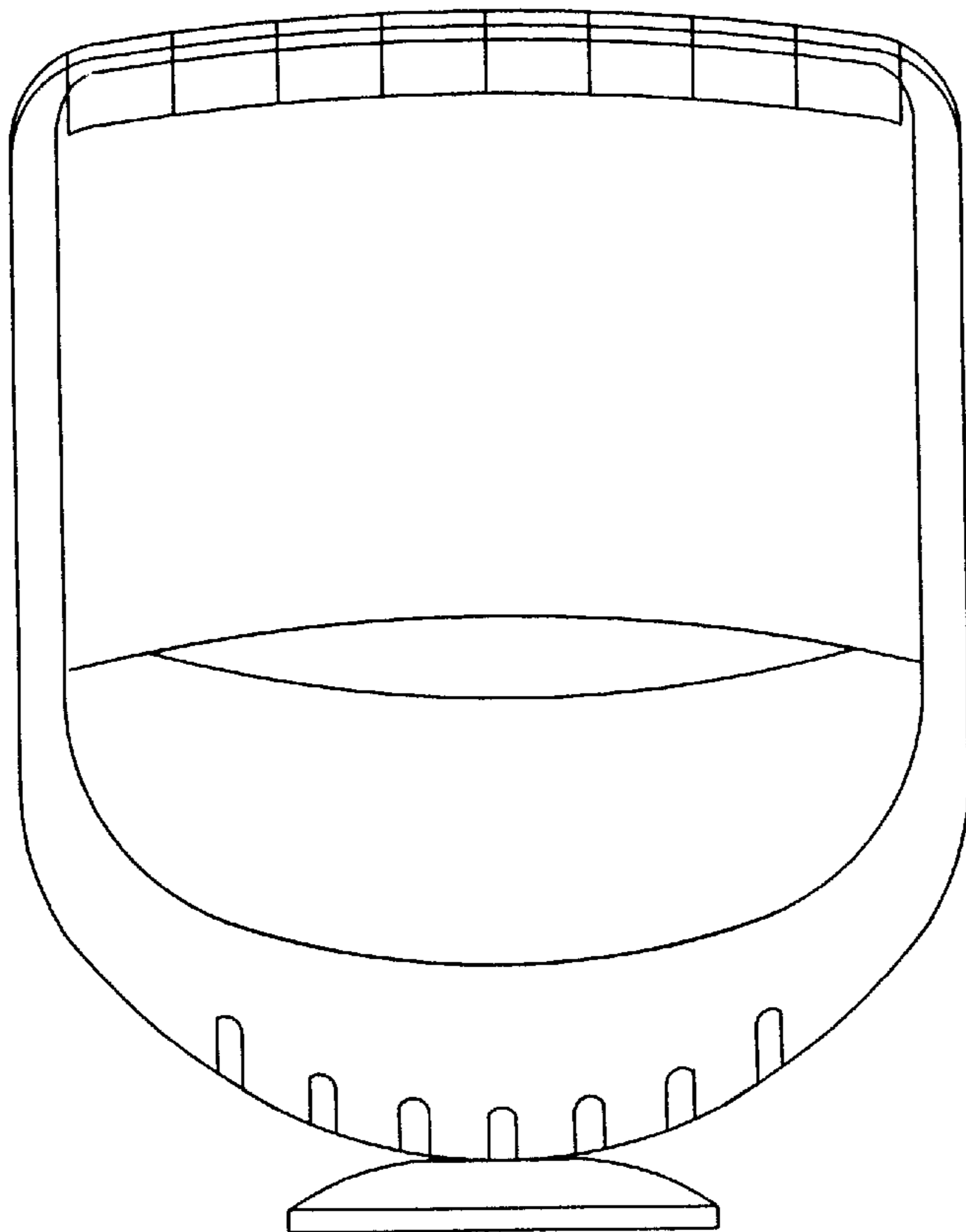

FIG. 4

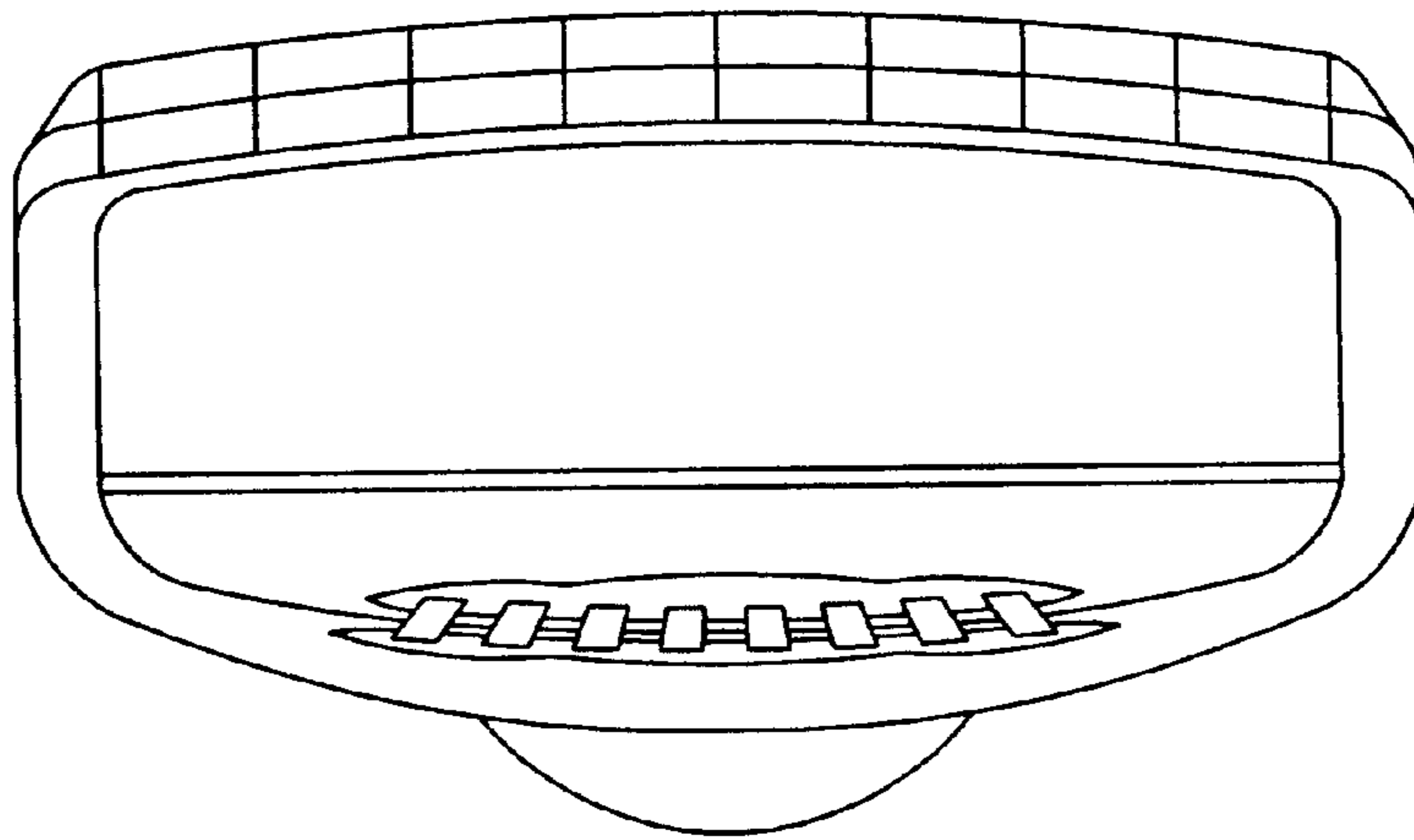

FIG. 5

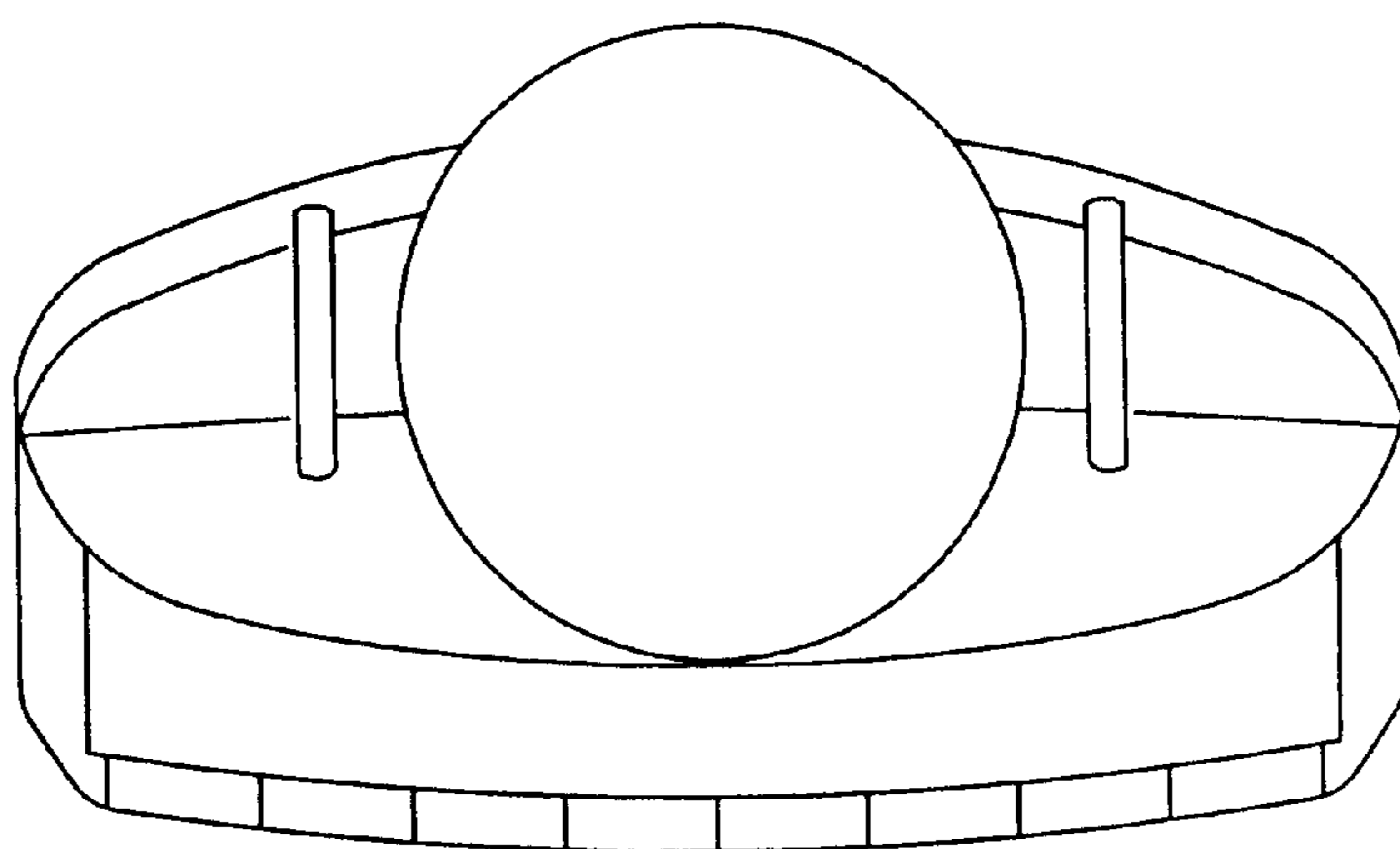

FIG. 6

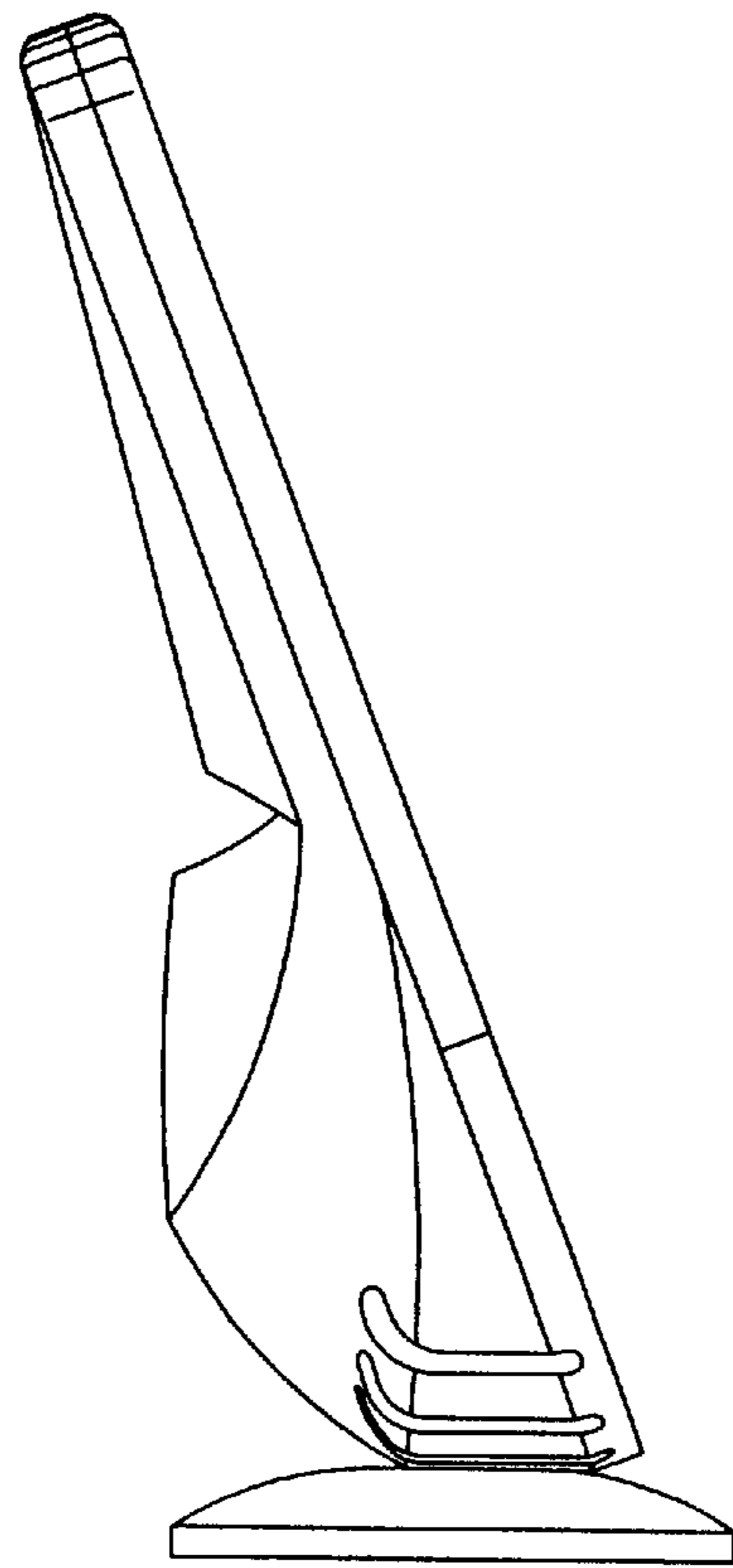

FIG. 7

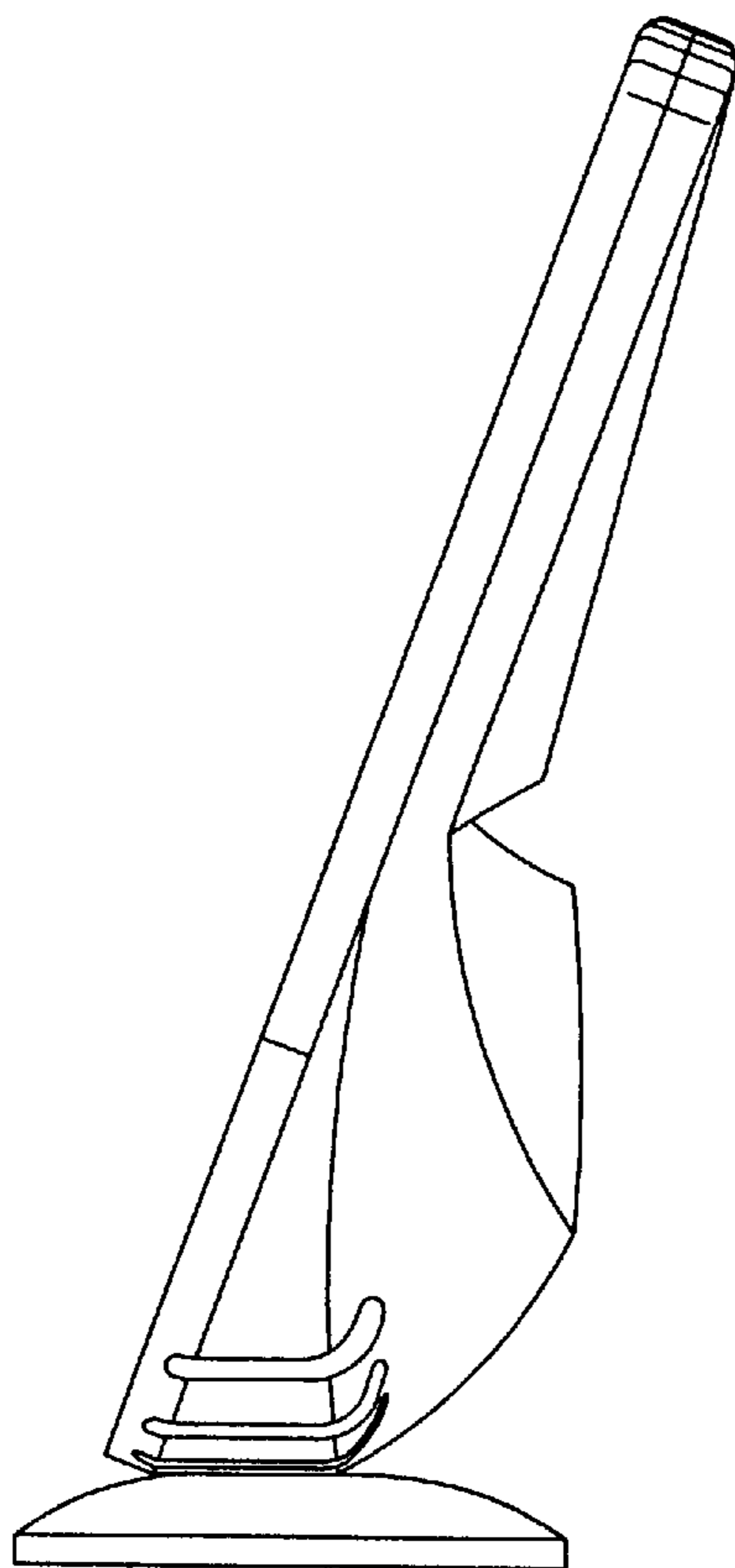

FIG. 8