



US00D525574S

(12) **United States Design Patent**
Conway et al.

(10) **Patent No.:** **US D525,574 S**
(45) **Date of Patent:** **** Jul. 25, 2006**

(54) **SUN VISOR**

(75) Inventors: **Scott M. Conway**, Flower Mound, TX
(US); **Jeffrey P. Smith**, Prosper, TX
(US); **Louis D. Heilaneh**, Lewisville,
TX (US)

(73) Assignee: **PACCAR Inc**, Bellevue, WA (US)

(**) Term: **14 Years**

(21) Appl. No.: **29/239,780**

(22) Filed: **Oct. 4, 2005**

(51) **LOC (8) Cl.** **12-16**

(52) **U.S. Cl.** **D12/191**

(58) **Field of Classification Search** D12/191,
D12/181, 190, 182, 96-98; 296/95.1, 97.1,
296/97.9, 180.1; 160/DIG. 3, 370.21-370.23
See application file for complete search history.

(56) **References Cited**

U.S. PATENT DOCUMENTS

D154,861 S	*	8/1949	Maher	D12/191
D155,434 S	*	10/1949	Maher	D12/191
D156,479 S	*	12/1949	Bingman	D12/191
2,497,050 A	*	2/1950	Thibault	160/DIG. 3
D159,041 S	*	6/1950	Bihlmire	D12/191
D161,436 S	*	1/1951	Fausser	D12/191

D341,563 S	*	11/1993	Niemi	D12/191
D384,019 S	*	9/1997	Meryman et al.	D12/191
D403,999 S	*	1/1999	Lund	D12/191
D409,541 S	*	5/1999	Sproull et al.	D12/191
D414,150 S	*	9/1999	Sutton et al.	D12/181
D442,901 S	*	5/2001	Conway et al.	D12/191

* cited by examiner

Primary Examiner—Stacia Cadmus

(74) *Attorney, Agent, or Firm*—Sidley Austin LLP

(57) **CLAIM**

The ornamental design for a sun visor, as shown and described.

DESCRIPTION

FIG. 1 an oblique view of a sun visor showing our new design;
FIG. 2 is a front view;
FIG. 3 is a top view;
FIG. 4 a right side view, the left side view being a mirror image of that shown;
FIG. 5 is a back view; and,
FIG. 6 is a bottom view.

The sun visor is shown on an enlarged scale in FIGS. 2-6. The broken line showing of environment is for illustrative purposes only and forms no part of the claimed design.

1 Claim, 3 Drawing Sheets

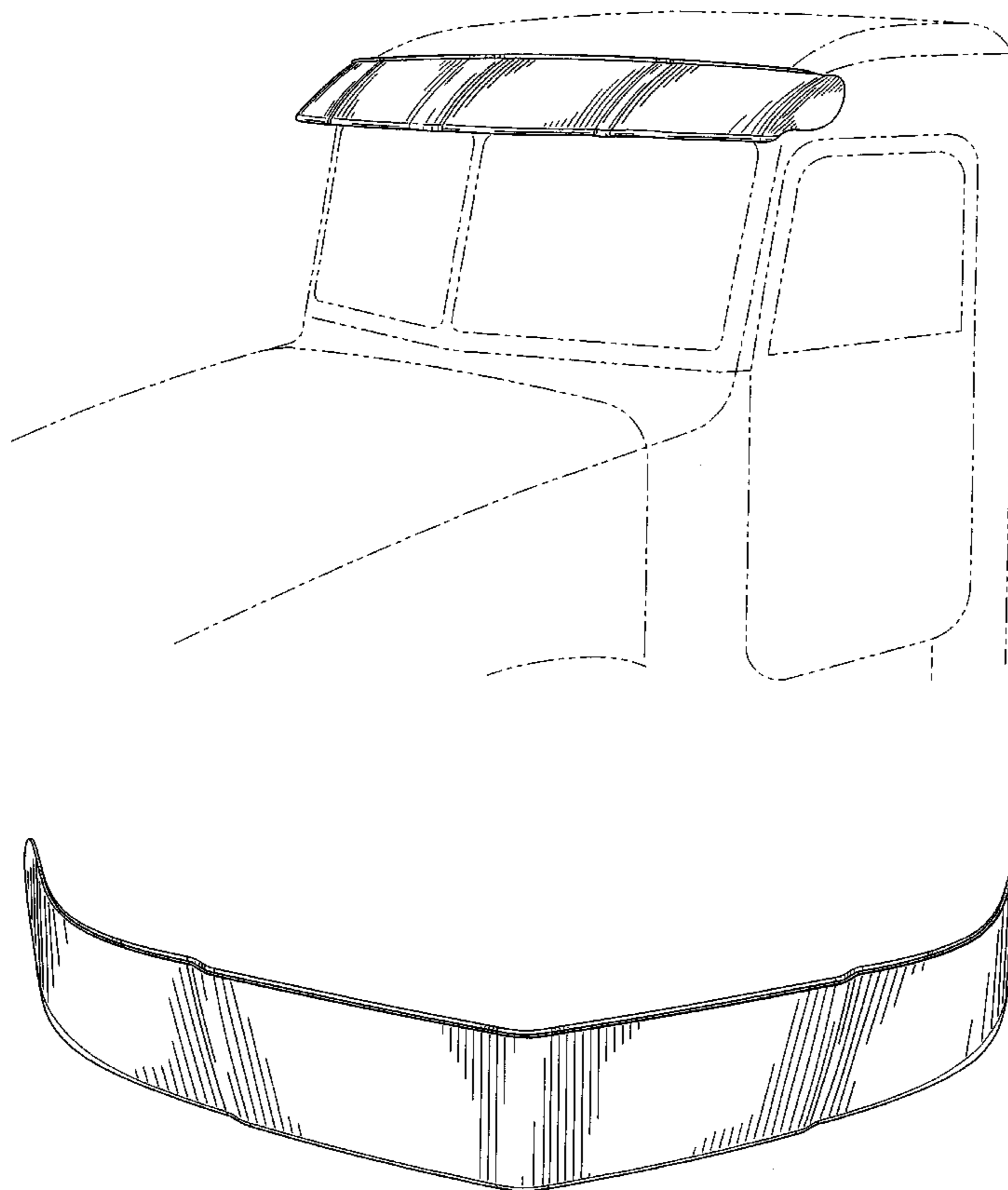

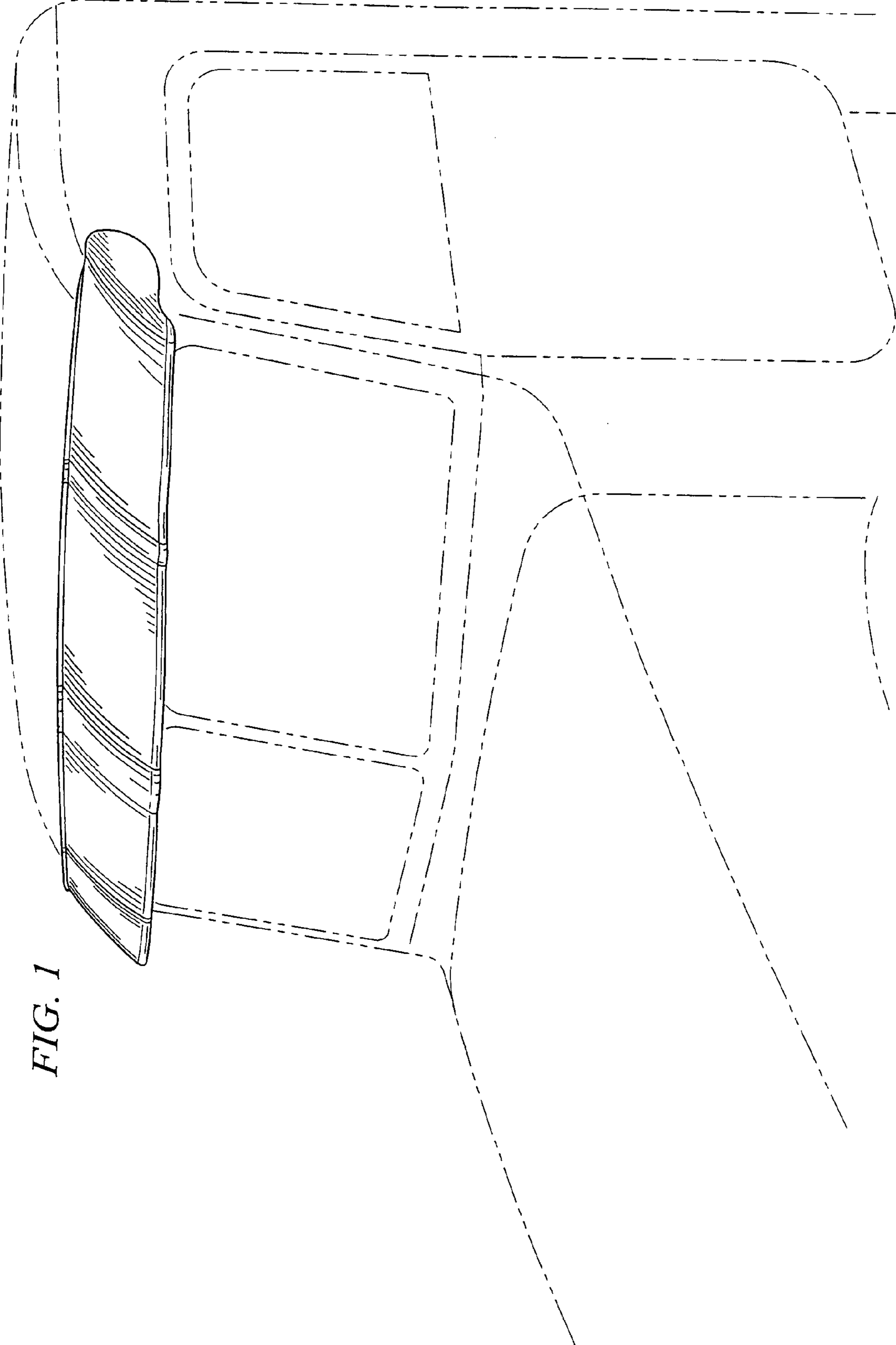

FIG. 1

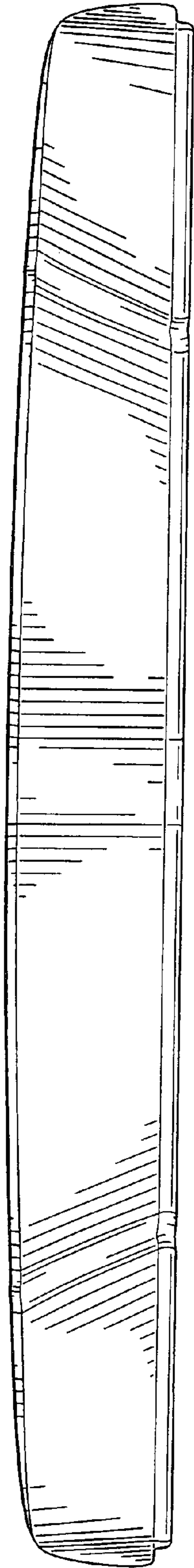

FIG. 2

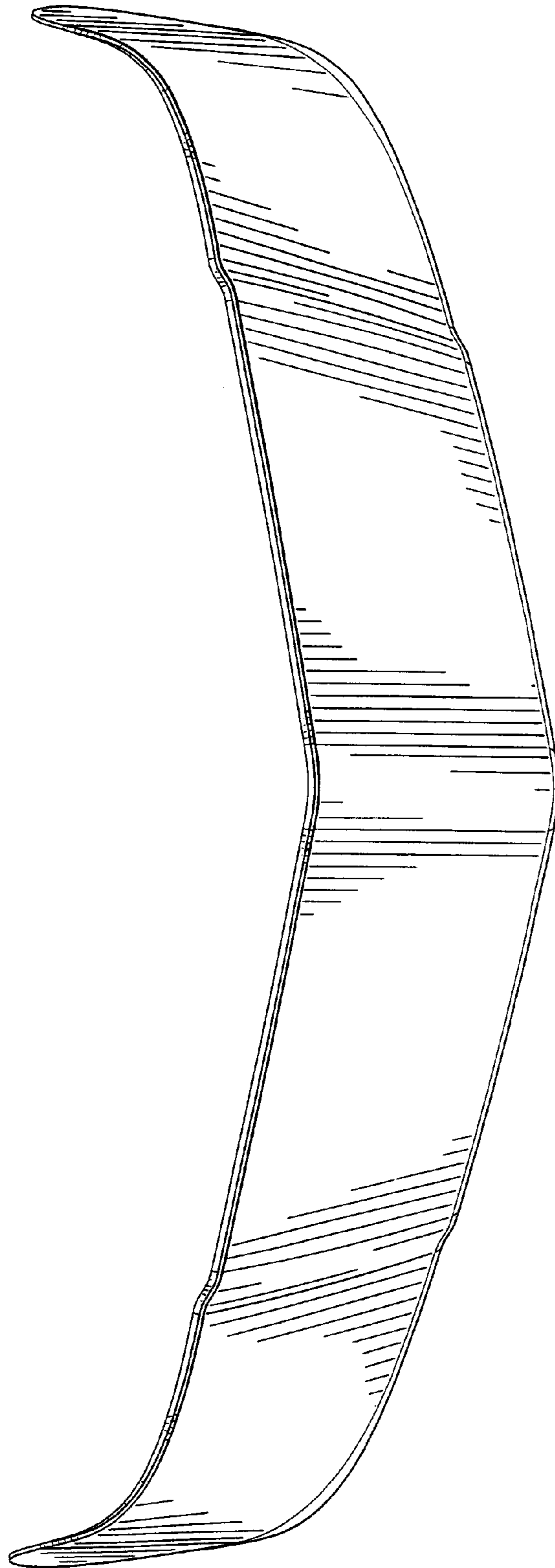

FIG. 3

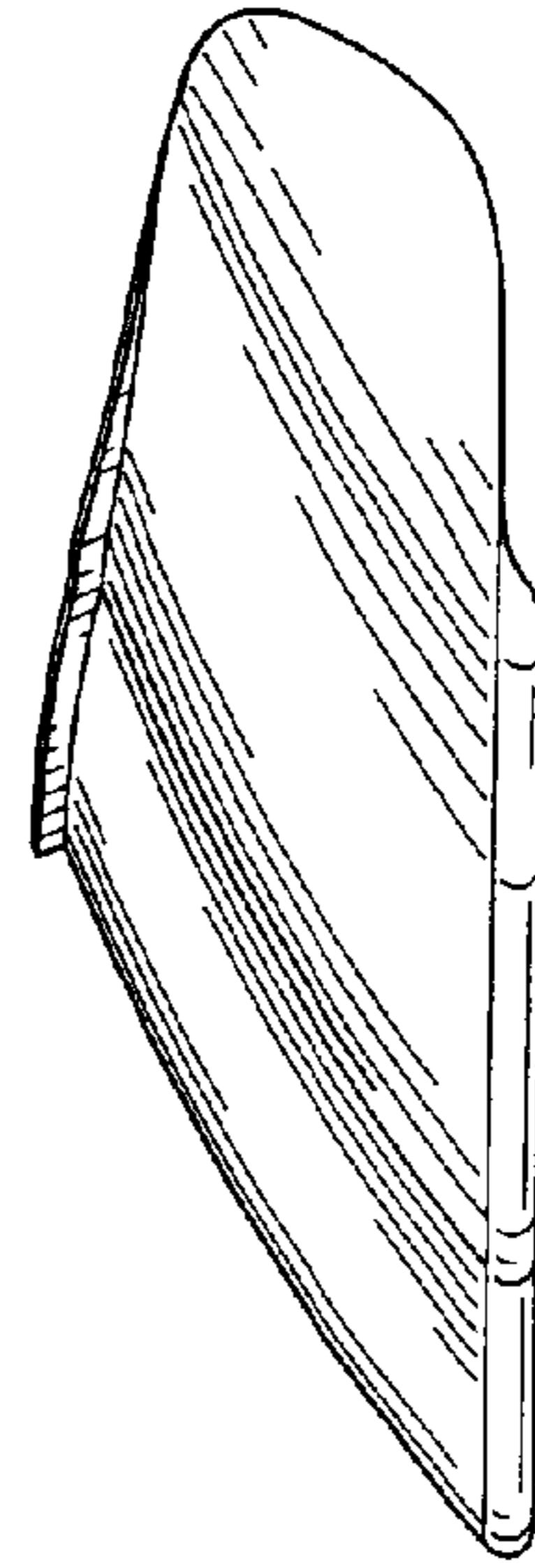

FIG. 4

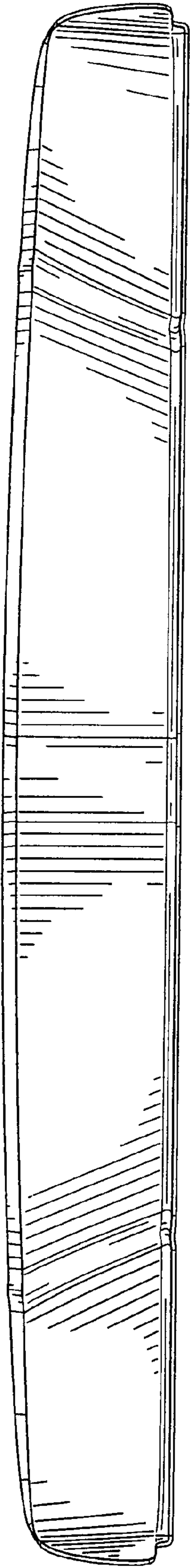

FIG. 5

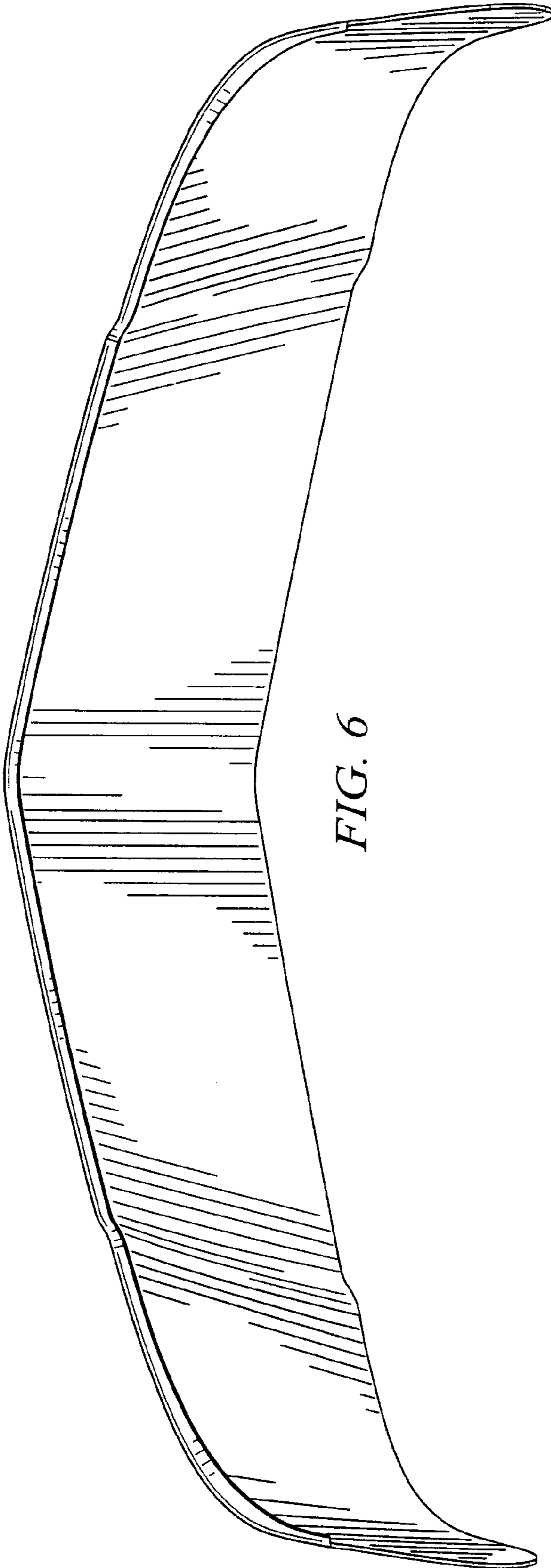

FIG. 6