



US00D525464S

(12) **United States Design Patent**  
**Khurana**

(10) **Patent No.:** **US D525,464 S**

(45) **Date of Patent:** **\*\* Jul. 25, 2006**

(54) **BABY WIPES CONTAINER**

(75) Inventor: **Dalbir Singh Khurana**, Bangkok (TH)

(73) Assignee: **Royal King Infant Products Co., Ltd.**,  
Bangkok (TH)

(\*\*) Term: **14 Years**

(21) Appl. No.: **29/211,705**

(22) Filed: **Aug. 19, 2004**

(51) **LOC (8) Cl.** ..... **20-02**

(52) **U.S. Cl.** ..... **D6/518**

(58) **Field of Classification Search** ..... D6/515-523;  
206/225, 233, 389, 391, 812, 824; 211/13.1,  
211/45; 222/173, 180; 221/26, 33, 282-283;  
224/925; 242/570, 590; 248/309.1, 309.2,  
248/905; D12/17, 19

See application file for complete search history.

(56) **References Cited**

**U.S. PATENT DOCUMENTS**

D443,451 S	*	6/2001	Buck et al.	.....	D6/518
D468,567 S	*	1/2003	Trevett et al.	.....	D6/515
D485,461 S	*	1/2004	Sams et al.	.....	D6/515
D495,545 S	*	9/2004	Niehues	.....	D6/518

D495,910 S \* 9/2004 Zaidman ..... D6/518

\* cited by examiner

*Primary Examiner*—Brian N Vinson

(74) *Attorney, Agent, or Firm*—Davis & Bujold, P.L.L.C.

(57) **CLAIM**

The ornamental design for a baby wipes container, as shown and described.

**DESCRIPTION**

FIG. 1 is a front perspective view of a baby wipes container showing my new design;

FIG. 2 is a top view thereof;

FIG. 3 is a left side elevational view thereof;

FIG. 4 is a right side elevational view thereof;

FIG. 5 is a rear elevational view thereof;

FIG. 6 is a front elevational view thereof; container;

FIG. 7 is a bottom view thereof;

FIG. 8 is a front perspective view of a second embodiment thereof, the only difference being the absence of the intaglio image on the lid of the container;

FIG. 9 is a top view thereof;

FIG. 10 is a left side elevational view thereof;

FIG. 11 is a right side elevational view thereof;

FIG. 12 is a rear elevational view thereof;

FIG. 13 is a front elevational view thereof; and,

FIG. 14 is a bottom plan view thereof.

**1 Claim, 10 Drawing Sheets**

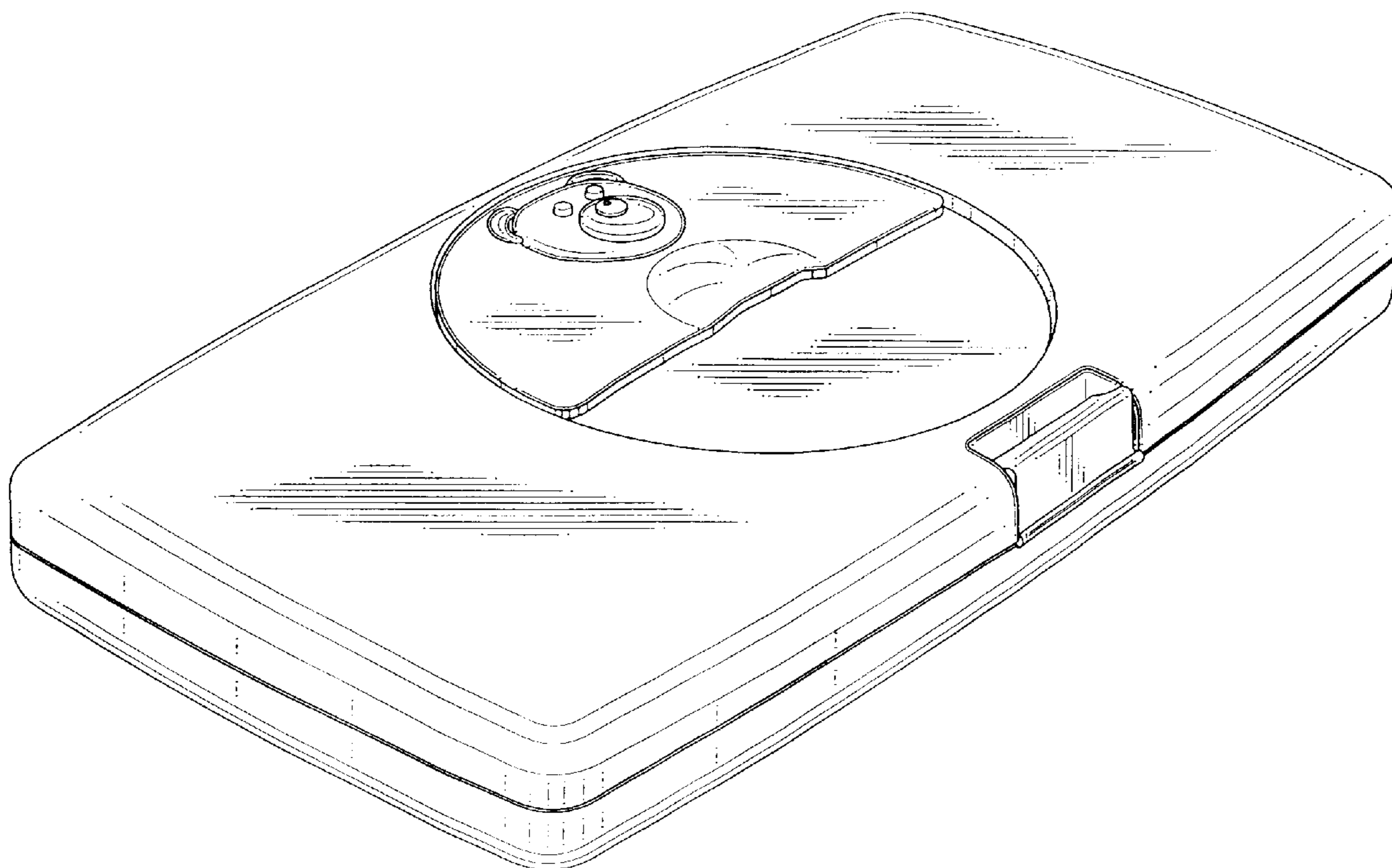

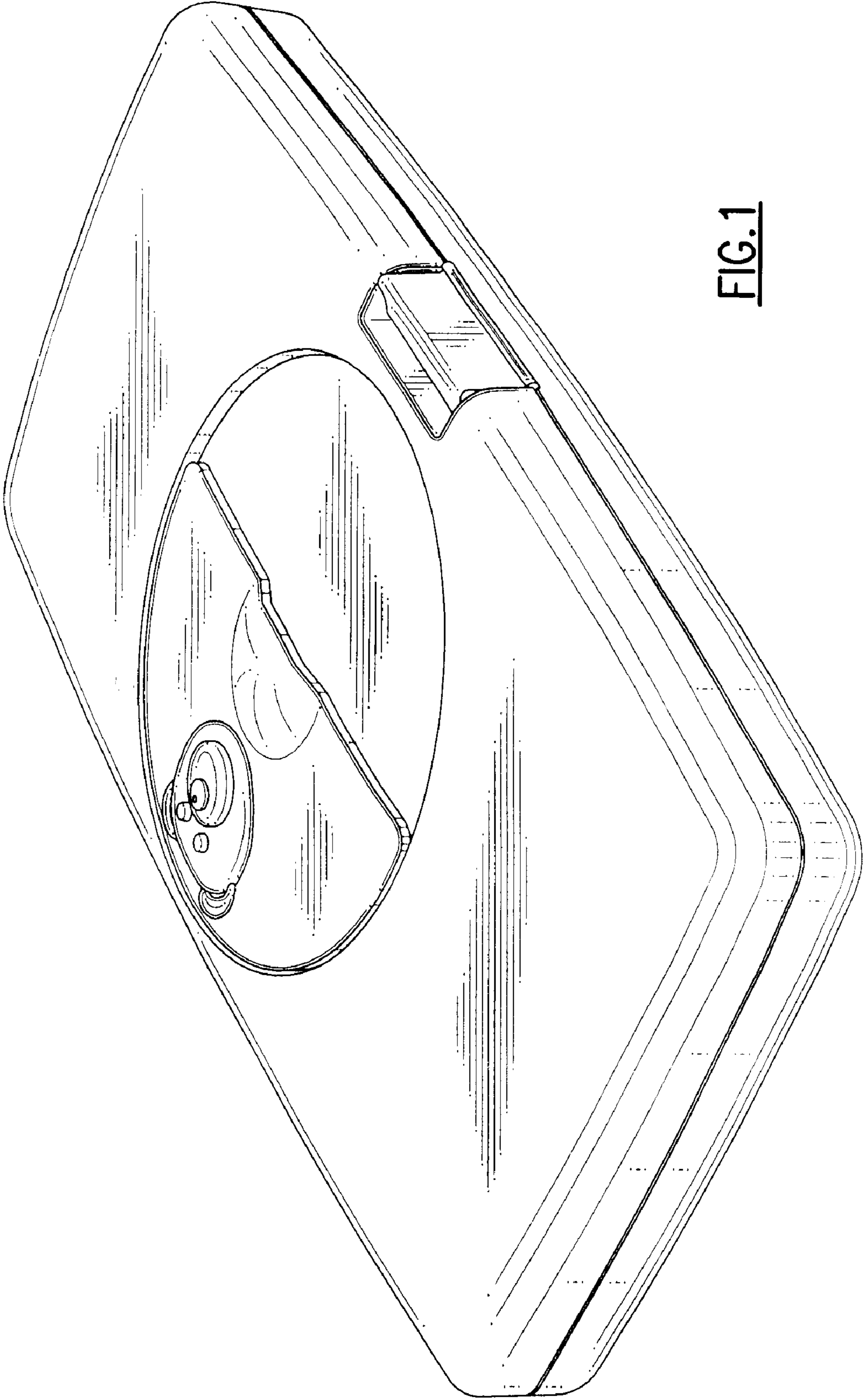

FIG. 1

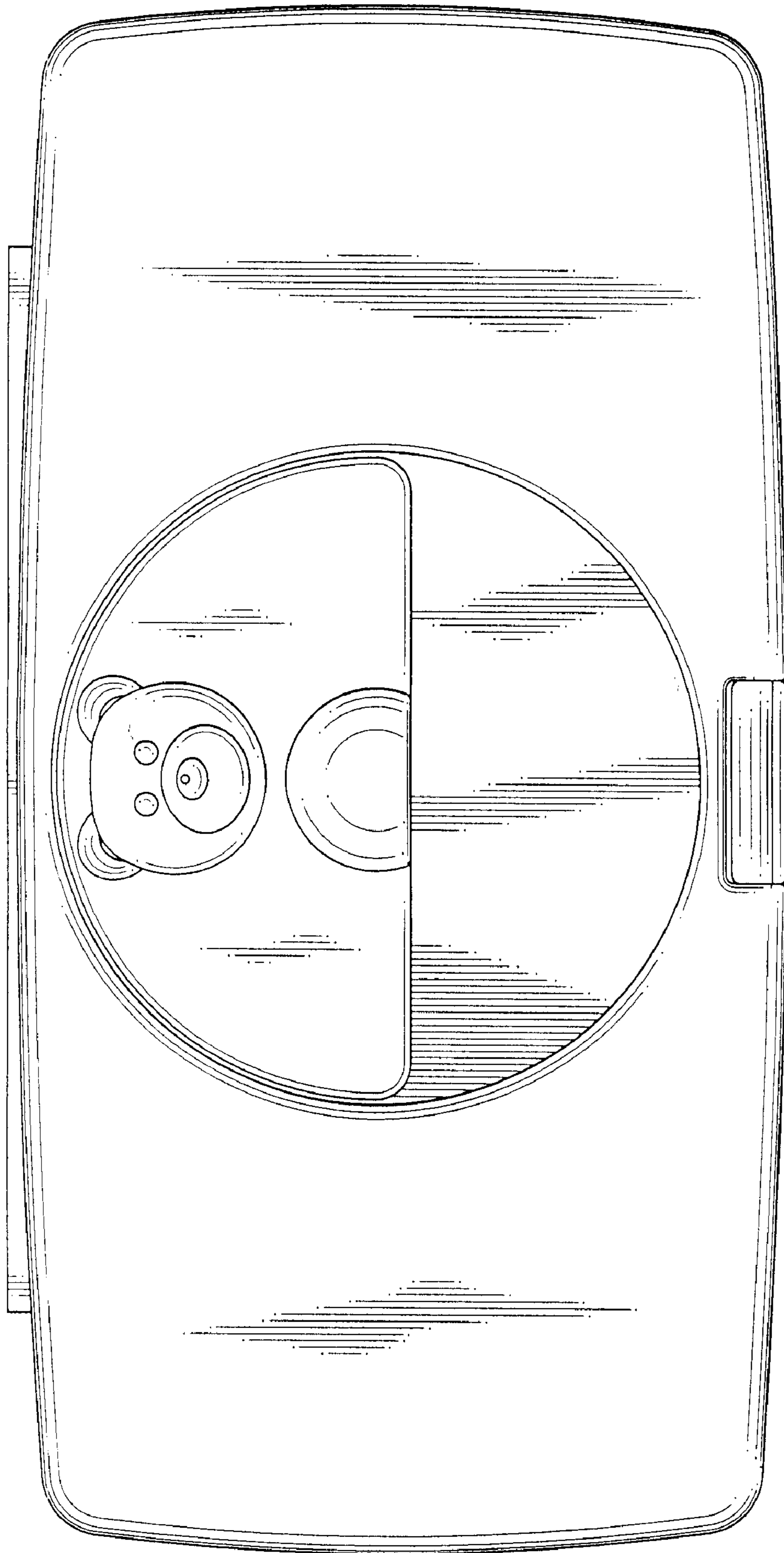

FIG. 2

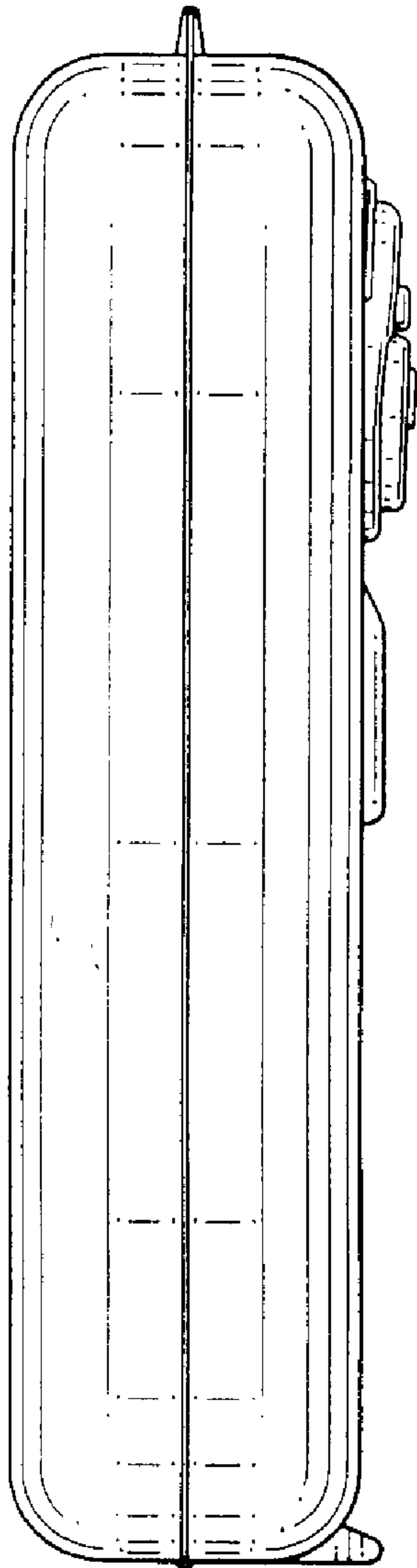

FIG. 3

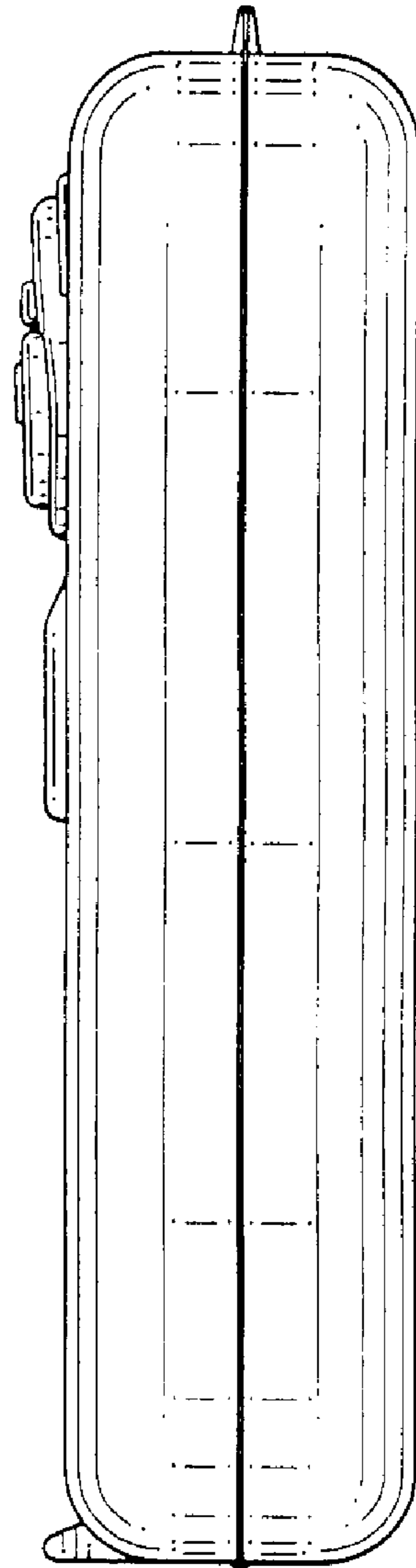

FIG. 4

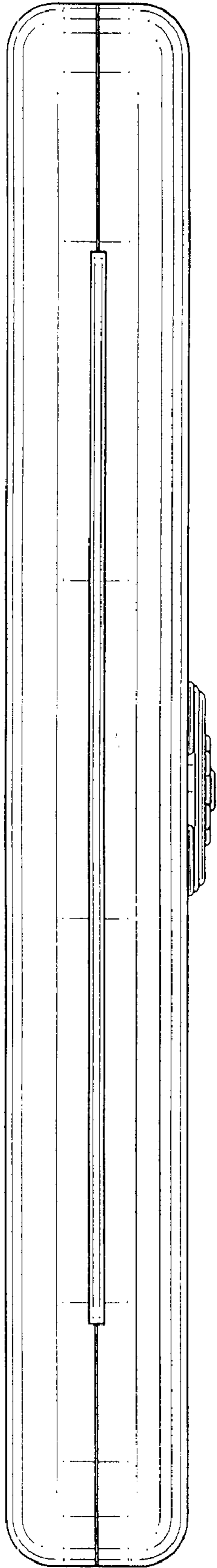

FIG. 5

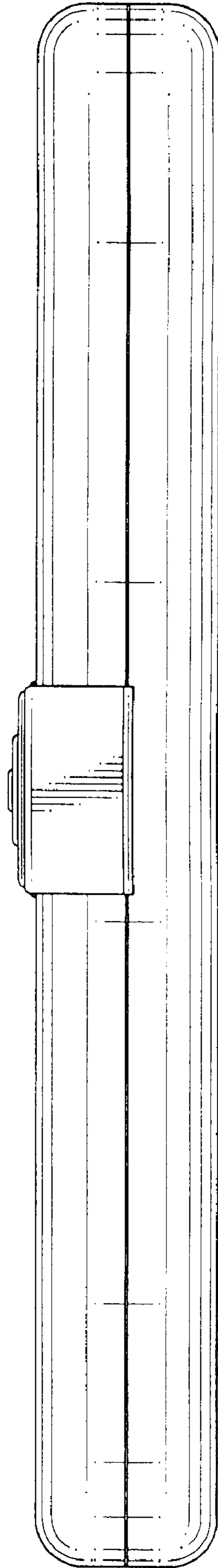

FIG. 6

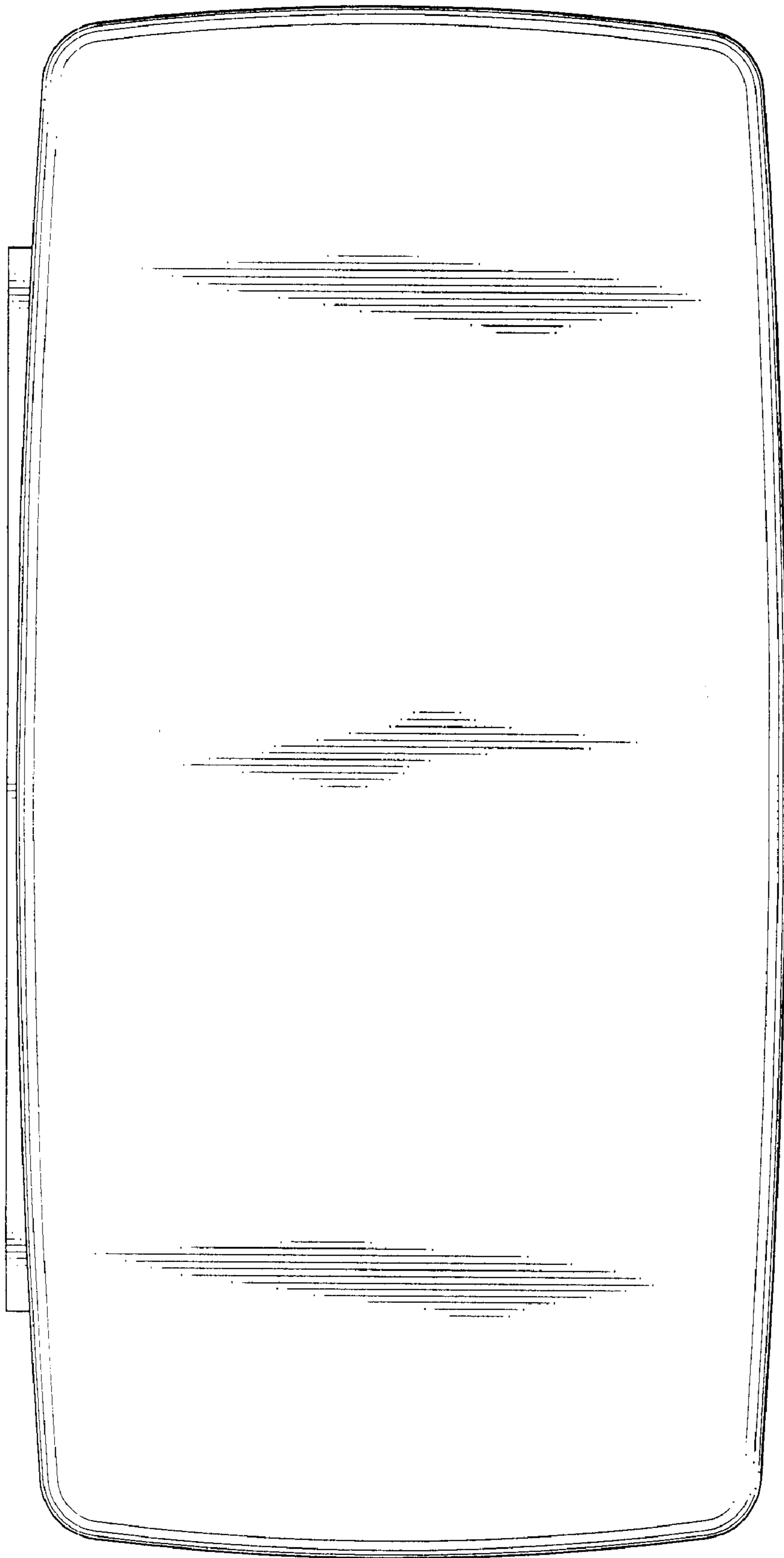

FIG. 7

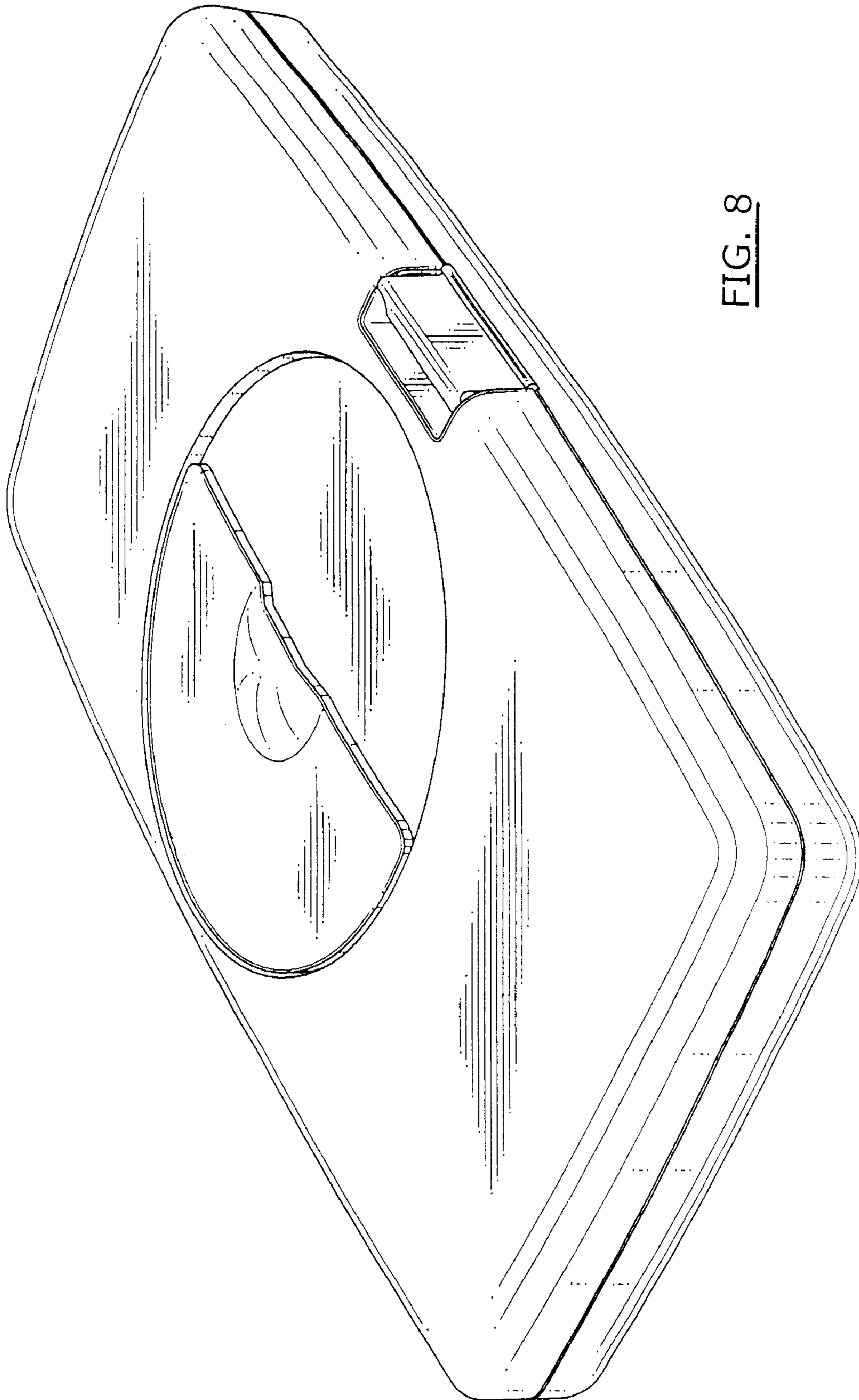

FIG. 8

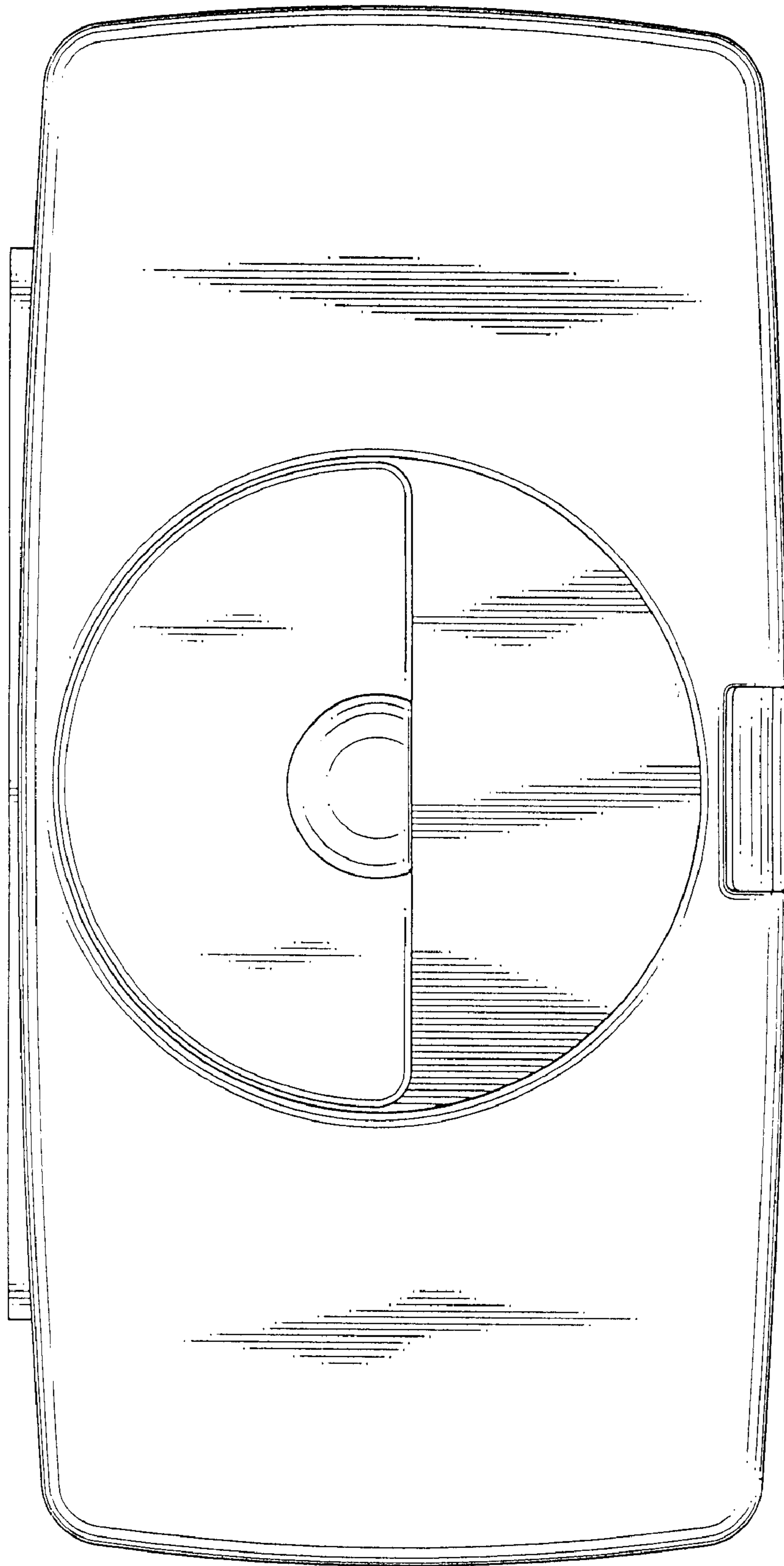

FIG. 9



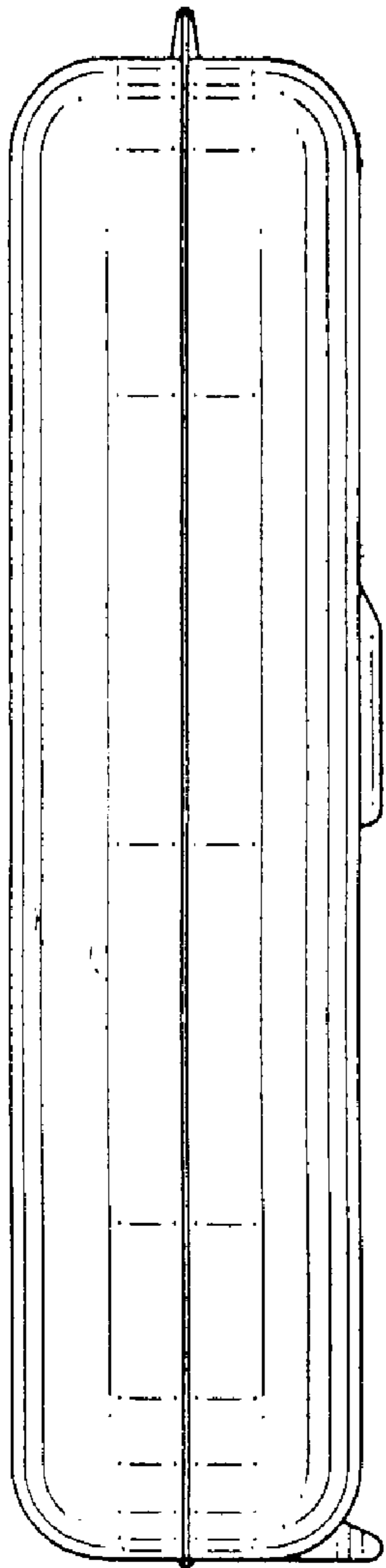

FIG. 10

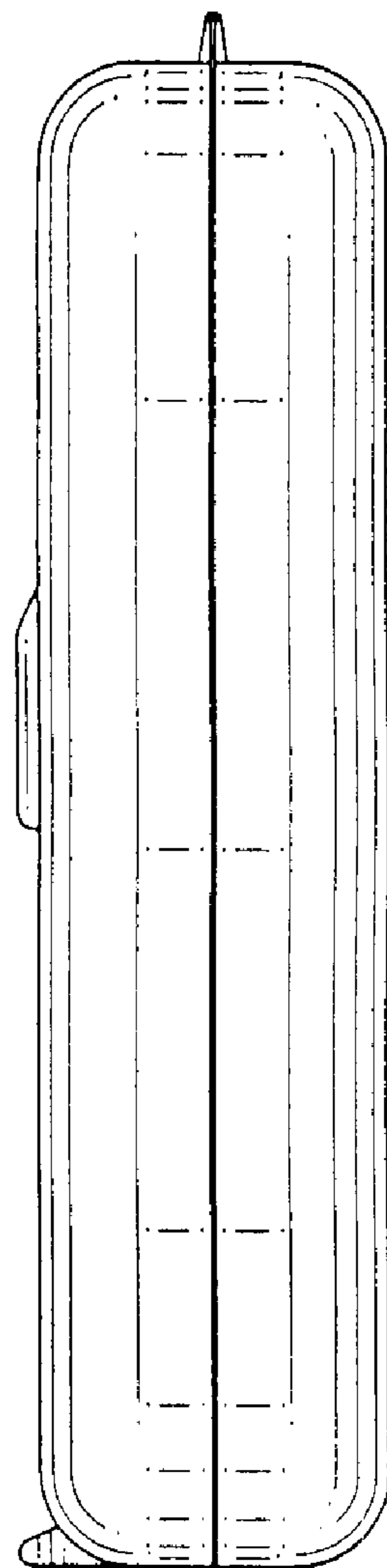

FIG. 11

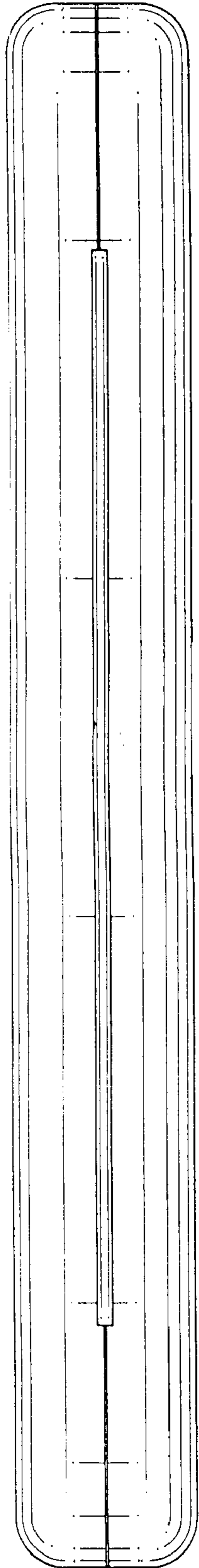

FIG. 12

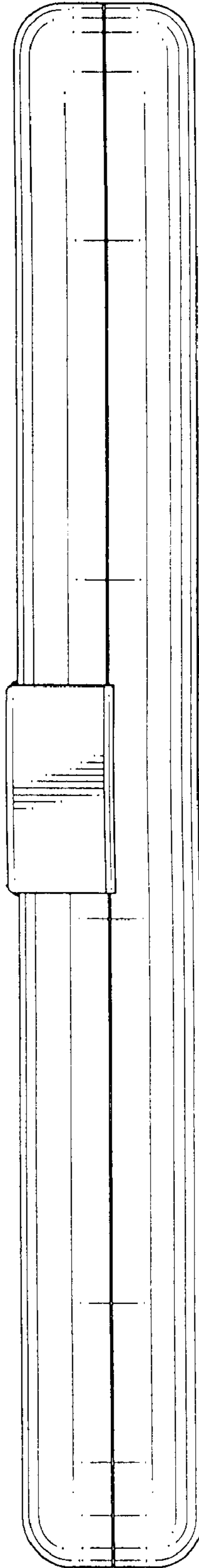

FIG. 13

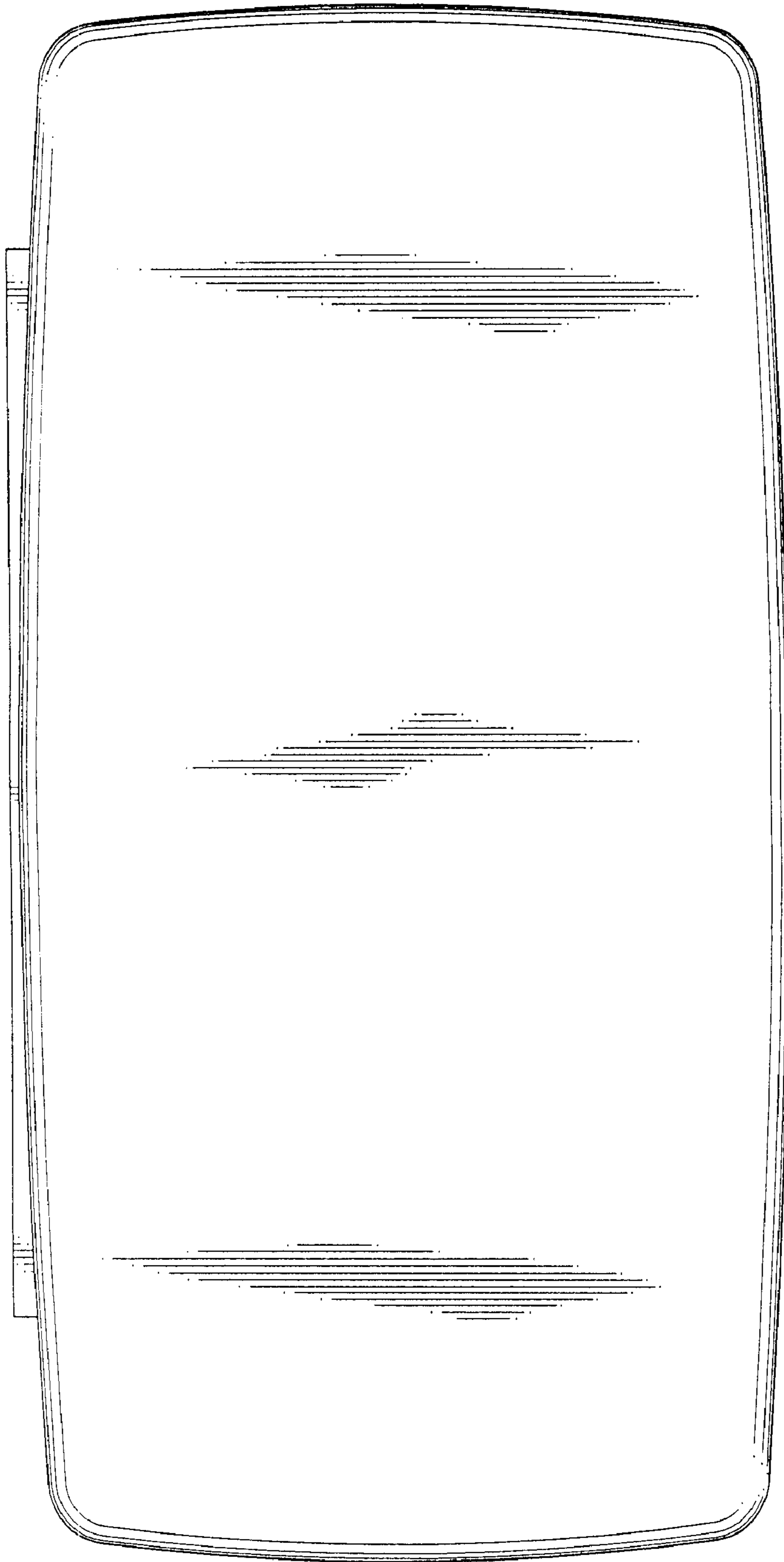

FIG. 14