



US00D525441S

(12) **United States Design Patent**  
**Pomeroy et al.**

(10) **Patent No.:** **US D525,441 S**  
(45) **Date of Patent:** **\*\* Jul. 25, 2006**

(54) **TETE-A-TETE GLIDER CHAIRS**

(75) Inventors: **Charles Pomeroy**, South Bend, IN (US); **John T. Bycraft**, South Bend, IN (US)

(73) Assignee: **Jack-Post Corporation**, Buchanan, MI (US)

(\*\*) Term: **14 Years**

(21) Appl. No.: **29/227,190**

(22) Filed: **Apr. 7, 2005**

(51) **LOC (8) Cl.** ..... **06-01**

(52) **U.S. Cl.** ..... **D6/336**

(58) **Field of Classification Search** ..... D6/334-339, D6/349, 352, 364-366, 353, 369, 370, 495, D6/500-502, 358, 351, 345, 367, 368, 379, D6/480, 481, 483, 484, 344, 347; 5/12.1; 297/445.1, 232, 446.1, 447.3, 448.1, 452.1, 297/118, 119, 122-126; 108/11, 13, 15, 115

See application file for complete search history.

(56) **References Cited**

**U.S. PATENT DOCUMENTS**

|             |         |        |
|-------------|---------|--------|
| 862,756 A   | 8/1907  | Potter |
| 1,177,899 A | 4/1916  | Rogers |
| 1,325,359 A | 12/1919 | Elzey  |
| 1,361,700 A | 12/1920 | Elzey  |

(Continued)

**OTHER PUBLICATIONS**

- 1987 Jack-Post Catalog: Outdoor Furniture/Outdoor Products.
- 1988 Jack Post Catalog: Outdoor Furniture/Outdoor Products/Building Products.
- 1989 Jack Post Catalog: Outdoor Furniture/Outdoor Products/Building Products.
- 1990 Iron Mountain Catalog: Fine Outdoor and Patio Furniture; Iron Mountain.
- 1991 Jack Post Catalog: Outdoor Furniture/Outdoor Products/Building Products.

1992 Jack Post Catalog: Outdoor Furniture/Outdoor Products/Building Products.

Leaflet: Grand Isle LGL-51HBZ Traditional High Back Glider and LGL-51Z Glider; Cardinal Home Products of Cleveland, Ohio; date unknown.

Leaflet: Grand Isle LGL-48JHBG High Bark Glider-Premium; Cardinal Home Products of Cleveland, Ohio, undated.

Leaflet: Grand Isle LGL-22JHBG High Back Chair; Cardinal Home Products of Cleveland, Ohio, undated.

Leaflet: Grand Isle LGL-22Z Glider Chair; Cardinal Home Products of Cleveland, Ohio, undated.

Leaflet: Grand Isle LGL-44TV Glider and LGL-44V Glider; Cardinal Home Products of Cleveland, Ohio, undated.

Leaflet: Grand Isle LGL-48TZ Deluxe Glider With Side Tables and LGL-48Z Deluxe Glider; Cardinal Home Products of Cleveland, Ohio, undated.

Leaflet: Grand Isle LGL-60TV 6' Glider and LGL-60V 6' Glider; Cardinal Home Products of Cleveland, Ohio, undated.

(Continued)

*Primary Examiner*—Sandra S. Snapp

(74) *Attorney, Agent, or Firm*—Jenkins & Gilchrist

(57) **CLAIM**

The ornamental design for tete-a-tete glider chairs, as shown and described.

**DESCRIPTION**

FIG. 1 is a front perspective view of the tete-a-tete glider chairs showing our new design;

FIG. 2 is a front elevational view;

FIG. 3 is a rear elevational view;

FIG. 4 is an end elevational view from one end;

FIG. 5 is a top plan view; and,

FIG. 6 is a bottom plan view.

The broken lines shown in the drawings are for illustrative purposes only and form no part of the claimed design.

**1 Claim, 6 Drawing Sheets**

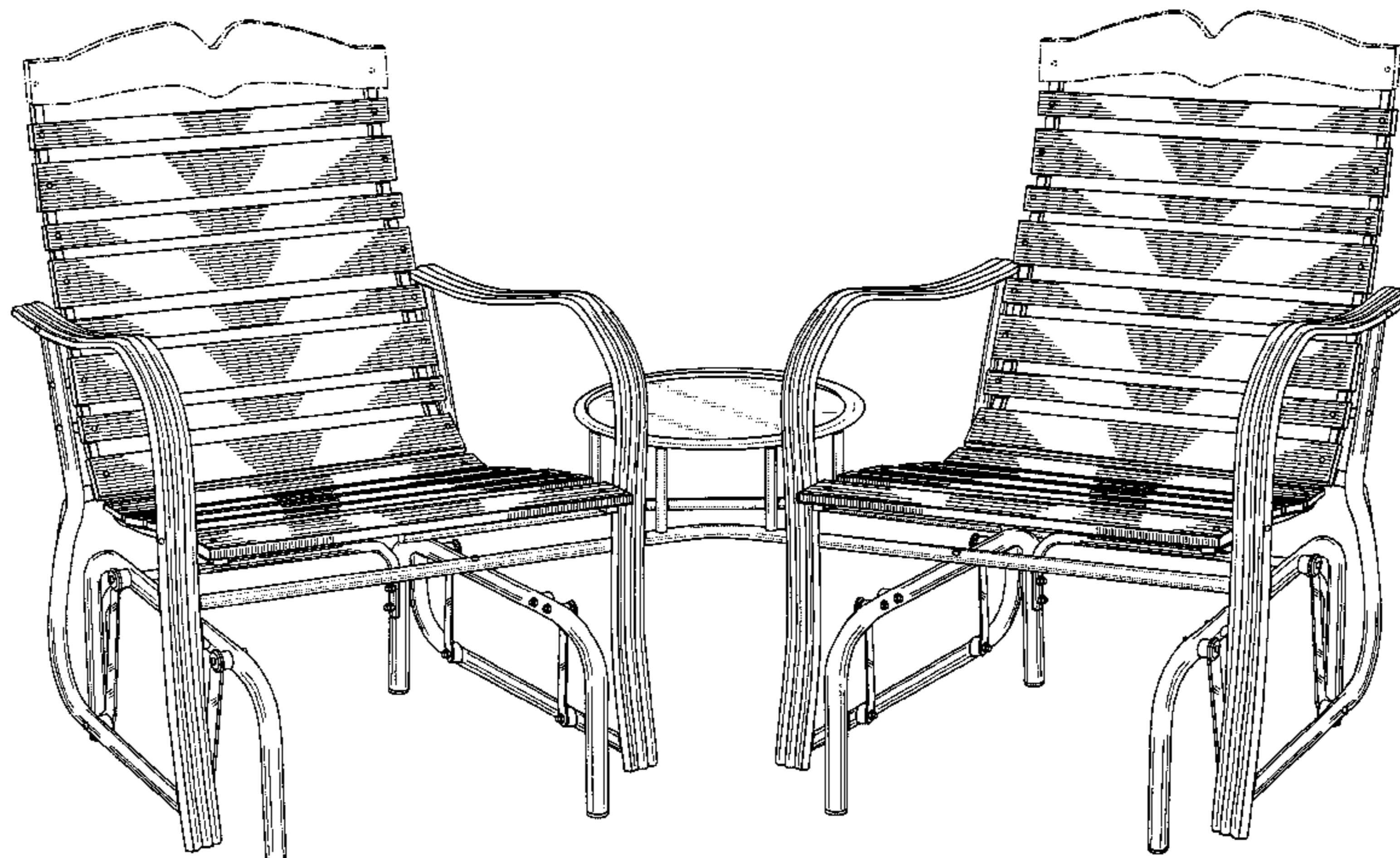

U.S. PATENT DOCUMENTS

|           |   |           |                 |         |
|-----------|---|-----------|-----------------|---------|
| 1,417,443 | A | 5/1922    | Baughner et al. |         |
| D92,012   | S | 4/1934    | McGowen         |         |
| D98,065   | S | 1/1936    | Hardy           |         |
| D99,375   | S | 4/1936    | Spangler        |         |
| D99,530   | S | 5/1936    | Spencer, III    |         |
| D103,956  | S | 4/1937    | Rink            |         |
| D110,560  | S | 7/1938    | Goldberg        |         |
| D121,462  | S | 7/1940    | Tabb            |         |
| D135,777  | S | 6/1943    | Smith           |         |
| D141,705  | S | 6/1945    | Slaughter       | D6/69   |
| D149,900  | S | 6/1948    | Mock            | D6/177  |
| D153,162  | S | 3/1949    | Nelems          | D6/347  |
| D154,356  | S | 7/1949    | Allmand         | D6/52   |
| 2,567,612 | A | 9/1951    | McGehee         | 155/61  |
| D165,835  | S | 2/1952    | Glass           | D6/146  |
| 3,078,101 | A | 2/1963    | Reese           | 280/30  |
| D212,878  | S | * 12/1968 | Muller et al.   | D6/336  |
| D214,041  | S | * 5/1969  | Shoemaker       | D6/336  |
| 3,994,468 | A | 11/1976   | Carter et al.   | 248/370 |
| D256,744  | S | 9/1980    | Mark            | D6/45   |
| D257,653  | S | 12/1980   | Berlic          | D6/177  |
| D259,308  | S | 5/1981    | Sroub           | D6/52   |
| D263,908  | S | 4/1982    | Imber           | D6/146  |
| D265,952  | S | 8/1982    | Theodore        | D6/45   |
| D268,551  | S | * 4/1983  | Raftery et al.  | D6/336  |
| D268,552  | S | * 4/1983  | Raftery et al.  | D6/336  |
| D281,376  | S | 11/1985   | Gregory, III    | D6/379  |
| D281,378  | S | 11/1985   | Parker          | D6/344  |
| D290,911  | S | 7/1987    | Pomeroy et al.  | D6/347  |
| D296,272  | S | 6/1988    | Colby           | D6/347  |
| D298,490  | S | 11/1988   | Pomeroy et al.  | D6/347  |
| 4,796,949 | A | 1/1989    | Boyce           | 297/259 |
| D306,530  | S | 3/1990    | Vanderminden    | D6/347  |
| D307,361  | S | 4/1990    | Pomeroy et al.  | D6/347  |
| D307,362  | S | 4/1990    | Pomeroy et al.  | D6/347  |
| D307,363  | S | 4/1990    | Pomeroy et al.  | D6/347  |
| 4,919,480 | A | 4/1990    | Drew, III       | 297/244 |
| D307,523  | S | 5/1990    | Pomeroy et al.  | D6/347  |
| D310,604  | S | 9/1990    | Pomeroy et al.  | D6/347  |
| 5,058,951 | A | 10/1991   | Thiel           | 297/278 |
| D325,823  | S | 5/1992    | Pomeroy et al.  | D6/335  |
| D327,584  | S | 7/1992    | Braxton, III    | D6/347  |
| D328,197  | S | 7/1992    | Braxton, III    | D6/347  |
| D334,485  | S | 4/1993    | Pomeroy et al.  | D6/344  |
| D338,563  | S | 8/1993    | Chiang          | D6/344  |
| D341,037  | S | 11/1993   | Pomeroy et al.  | D6/372  |
| D342,622  | S | * 12/1993 | Tseng           | D6/370  |
| D349,818  | S | 8/1994    | Noll            | D6/61   |
| D350,855  | S | 9/1994    | Pomeroy et al.  | D6/344  |
| D361,673  | S | 8/1995    | Pomeroy et al.  | D6/344  |
| D362,349  | S | 9/1995    | Pomeroy et al.  | D6/344  |
| D365,692  | S | 1/1996    | Pomeroy et al.  | D6/334  |
| 5,667,273 | A | 9/1997    | Noll            | 297/171 |

|           |    |           |                |         |
|-----------|----|-----------|----------------|---------|
| D400,720  | S  | 11/1998   | Pomeroy et al. | D6/334  |
| D401,090  | S  | 11/1998   | Pomeroy et al. | D6/500  |
| D410,340  | S  | 6/1999    | Pomeroy et al. | D6/344  |
| D415,623  | S  | * 10/1999 | Lin            | D6/370  |
| D417,559  | S  | 12/1999   | Pomeroy et al. | D6/344  |
| D430,743  | S  | 9/2000    | Pomeroy et al. | D6/336  |
| D432,323  | S  | 10/2000   | Pomeroy et al. | D6/344  |
| 6,199,950 | B1 | 3/2001    | Noll           | 297/273 |
| D443,425  | S  | 6/2001    | Pomeroy et al. | D6/344  |
| D449,454  | S  | 10/2001   | Pomeroy et al. | D6/344  |
| D450,193  | S  | 11/2001   | Pomeroy et al. | D6/344  |
| D450,937  | S  | 11/2001   | Pomeroy et al. | D6/344  |
| D464,492  | S  | 10/2002   | Pomeroy et al. | D6/336  |
| D467,741  | S  | 12/2002   | Pomeroy et al. | D6/346  |
| D468,916  | S  | 1/2003    | Pomeroy et al. | D6/346  |
| D475,540  | S  | 6/2003    | Pomeroy et al. | D6/344  |
| D477,468  | S  | * 7/2003  | Noll           | D6/344  |
| D492,852  | S  | 7/2004    | Pomeroy et al. | D6/344  |

OTHER PUBLICATIONS

Leaflet: Mountaineer Outdoor Furniture; Iron Mountain Forge; date Mar. 9, 1986.  
 Leaflet: Sunstar Double Glider, undated.  
 Leaflet: Sunstar Single Glider, undated.  
 Catalog: Lauan Mahogany Furniture; Cardinal American of Bedford Hts., Ohio; 1985.  
 Assembly Instructions for Your New Glider; C&H Houston, Inc. of Houston, Texas, undated.  
 Leaflet: 801106 5 ft. Glider; Flanders Industries, Inc. of Fort Smith, Arkansas, undated.  
 Leaflet: Glider; Oakwood Manufacturing Inc. of Oxford, Michigan, undated.  
 Leaflet: Glider; Iron Mountain Forge of Farmington, Missouri, undated.  
 Leaflet: Glider; Behlen Mfg. Co. of Columbia, Nebraska, undated.  
 Leaflet: Chair Gliders; Behlen Mfg. Co. of Columbus, Nebraska, undated.  
 1990 Jack-Post Catalog: Outdoor Furniture/Outdoor Products.  
 1993 Jack Post Catalog: Outdoor Furniture/Outdoor Products/Building Products.  
 1994 Jack Post Catalog: Thirtieth Anniversary.  
 1995 Jack Post Catalog: Outdoor Furniture/Outdoor Products/Building Products.  
 Flanders Industries, Inc. Royal Park Outdoor Furniture Glider from late 1980's.  
 2000 Jack-Post Furniture Products Catalog pp. 2, 3, 4, 6.  
 Leaflet: Holiday Club™ Patio Furniture Kits, undated.

\* cited by examiner

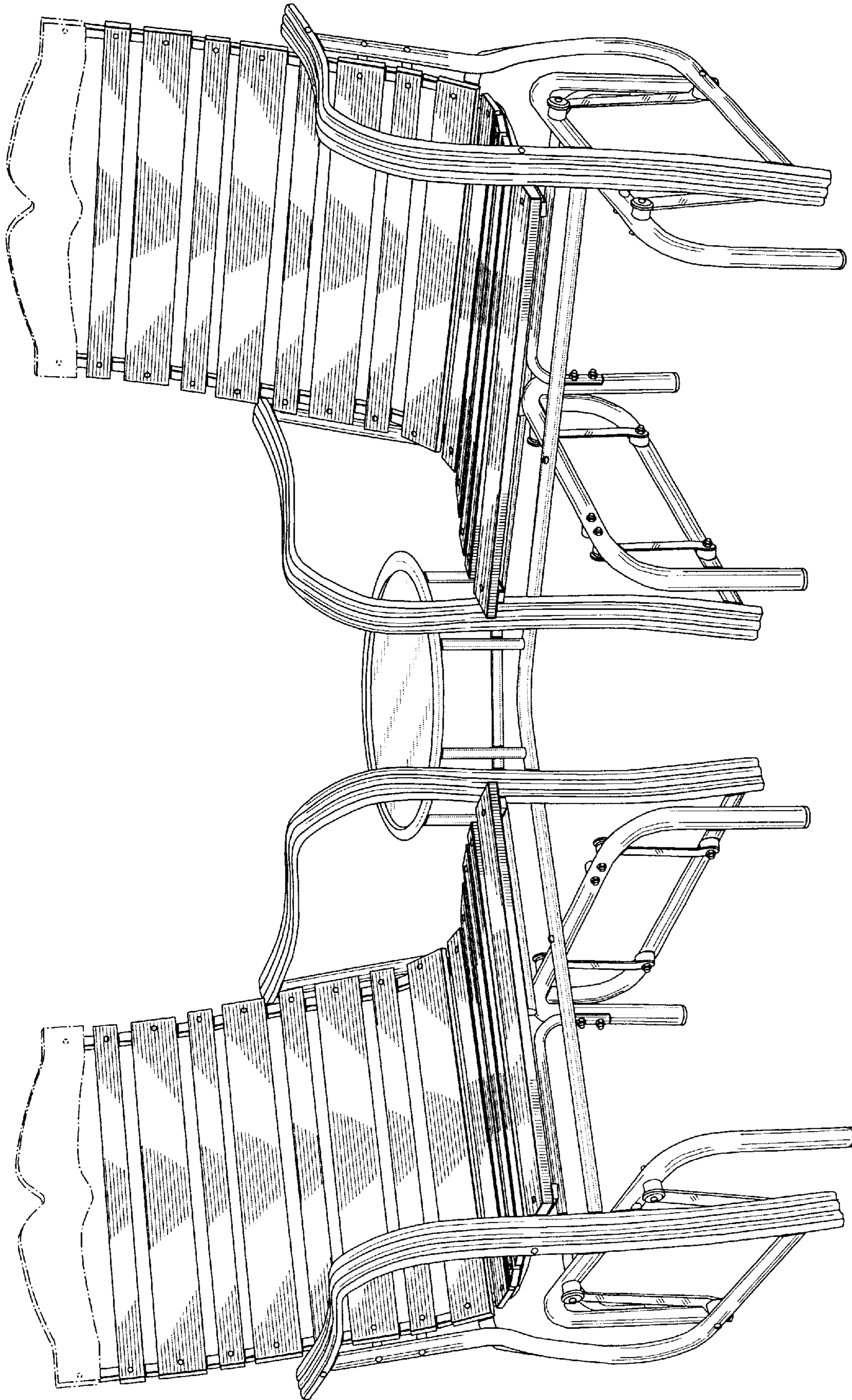

FIG. 1

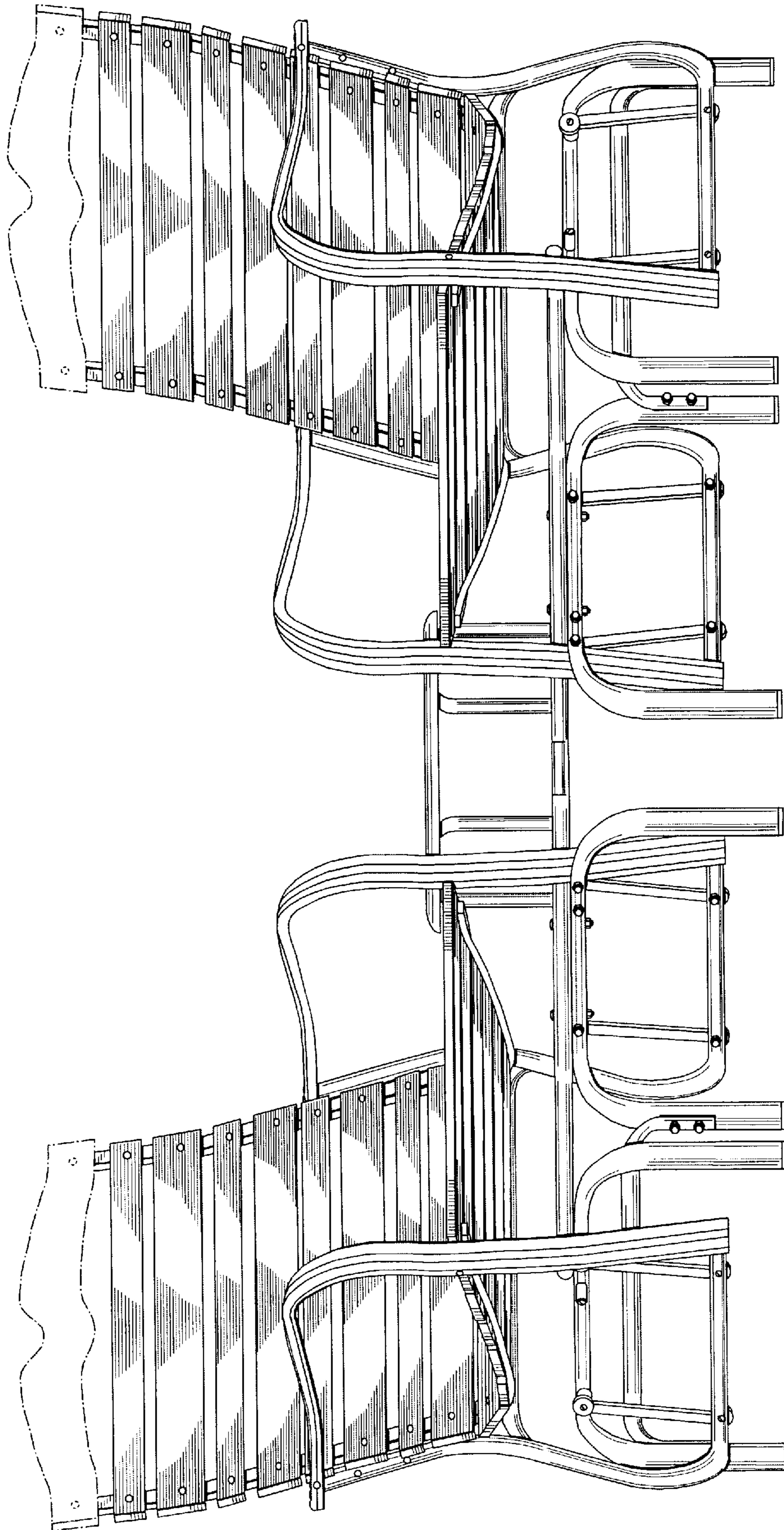

FIG. 2

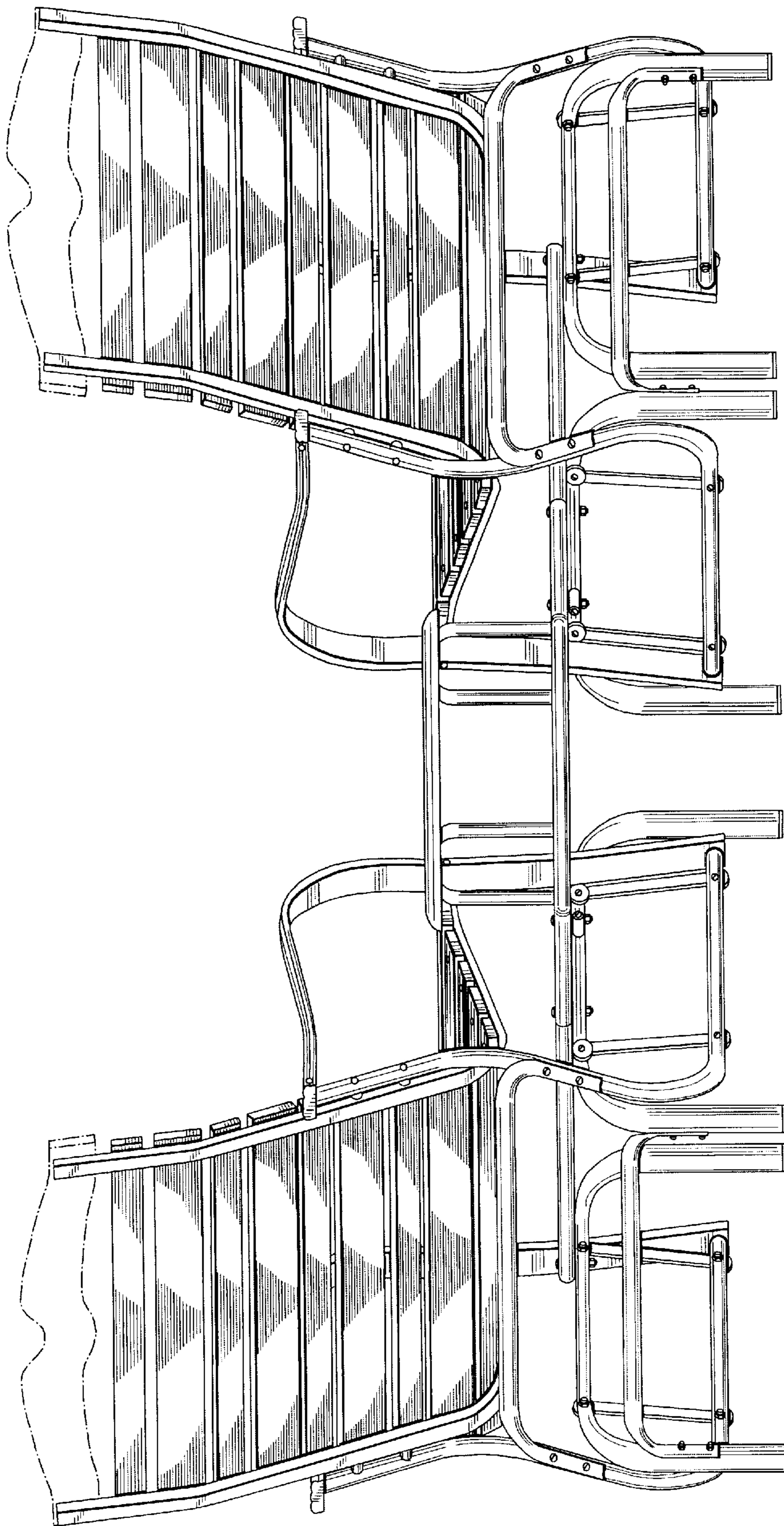

FIG. 3

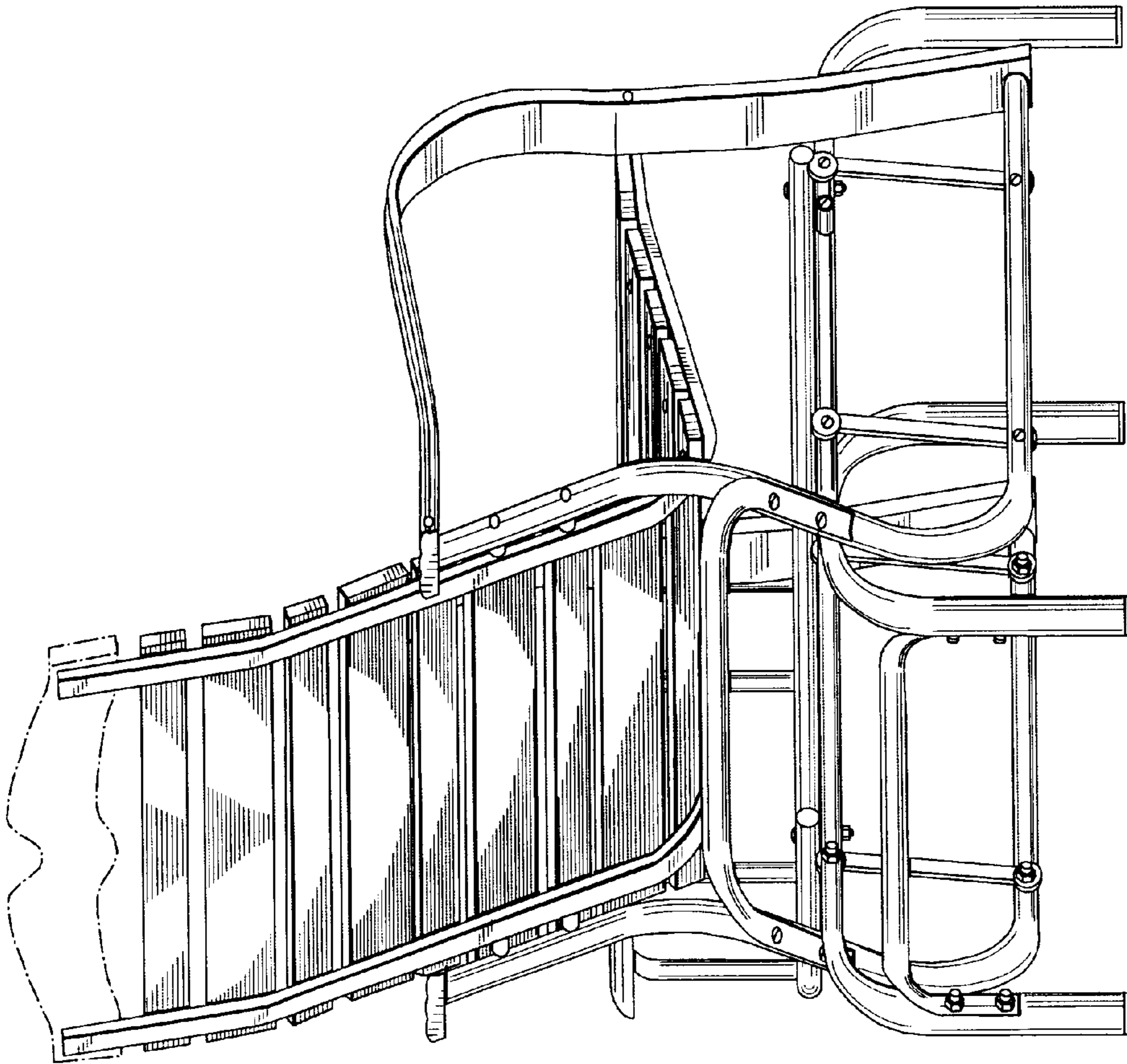

FIG. 4

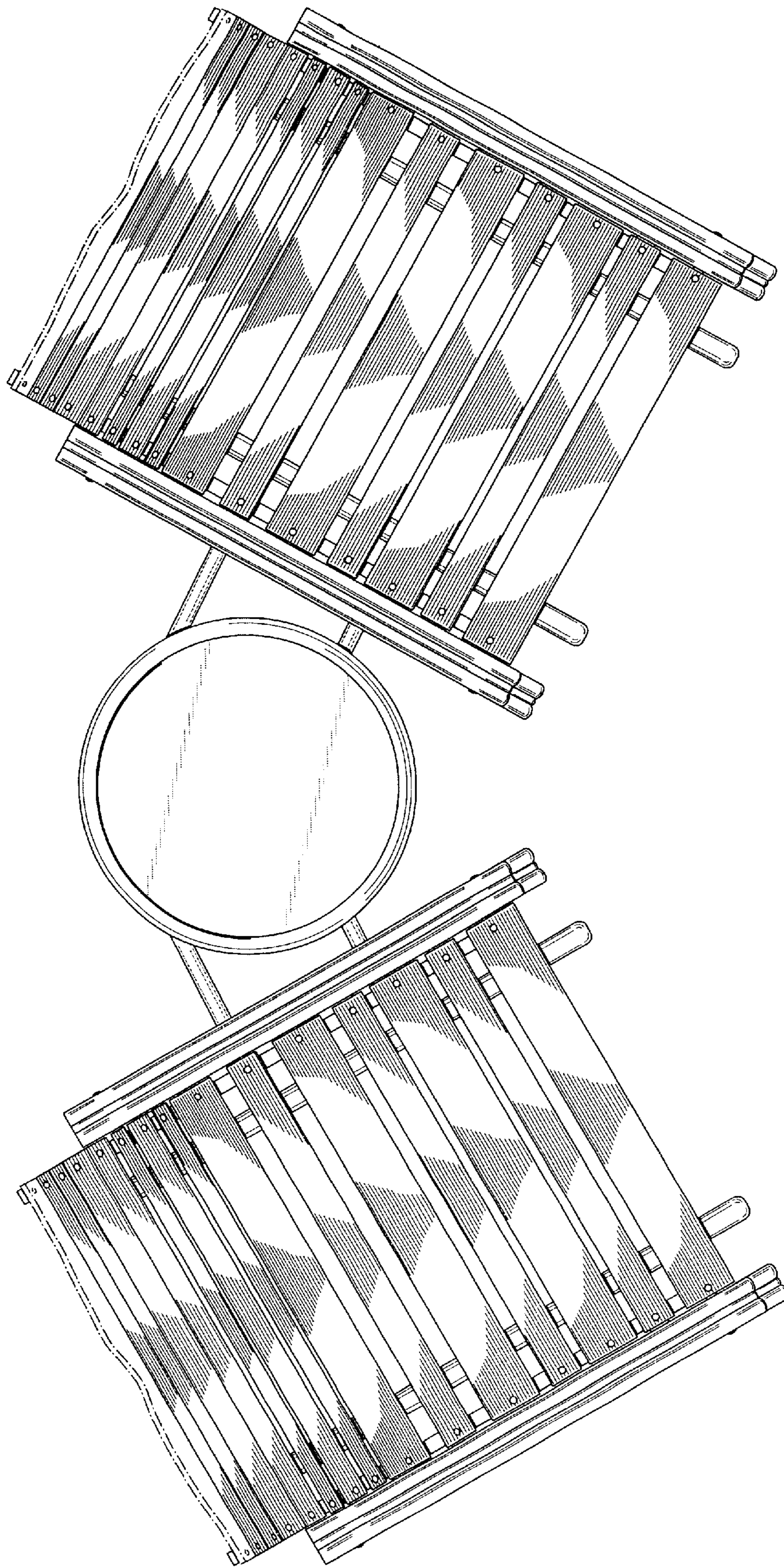

FIG. 5

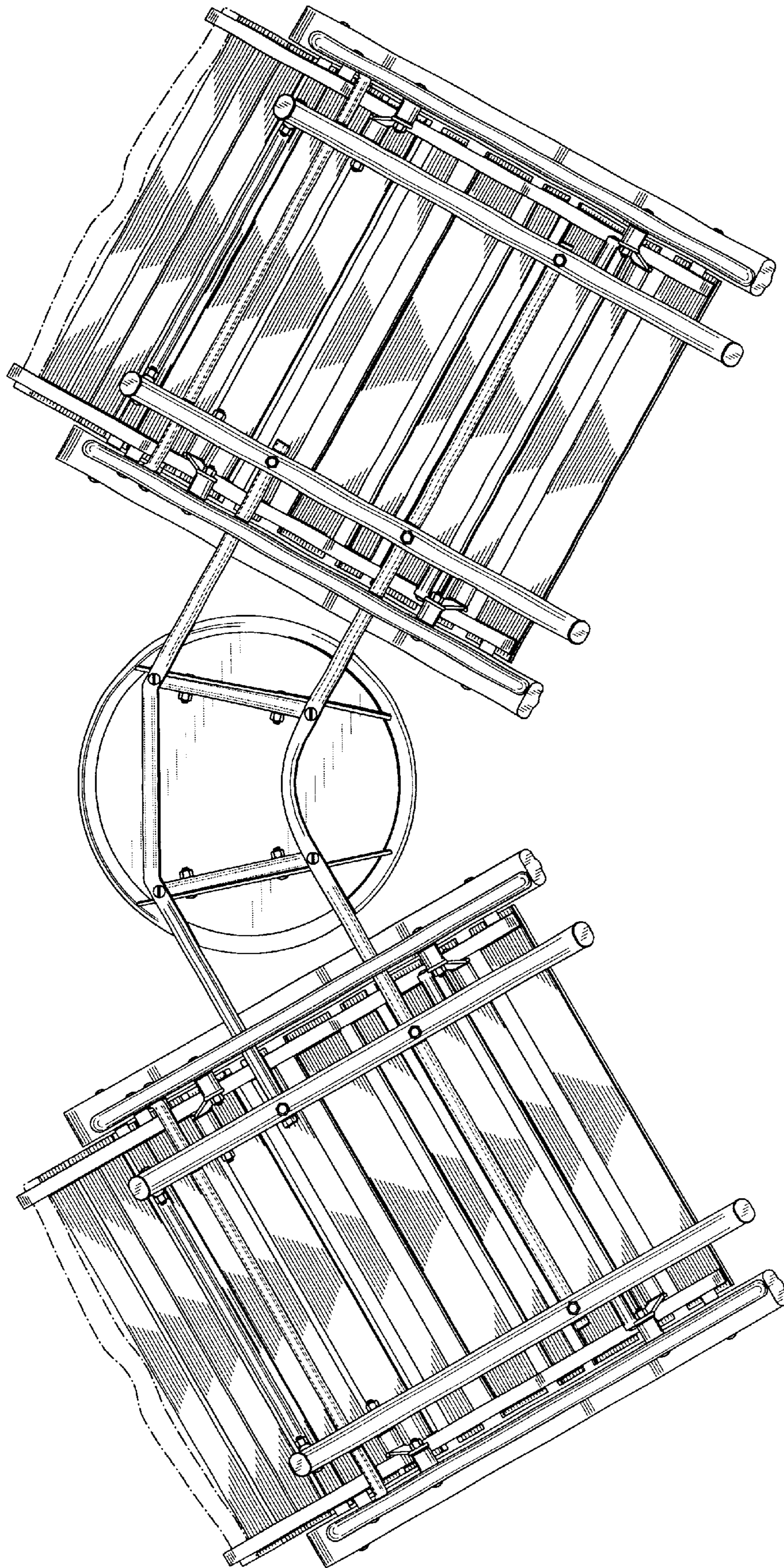

FIG. 6