

US00D525401S

(12) **United States Design Patent** (10) **Patent No.:** **US D525,401 S**  
**Kida** (45) **Date of Patent:** **\*\* Jul. 18, 2006**

(54) **OPTICAL CONNECTOR END-FACE CLEANER**

(75) Inventor: **Takahisa Kida**, Tokyo (JP)

(73) Assignee: **Seikoh Giken, Co., Ltd.** (JP)

(\*\*) Term: **14 Years**

(21) Appl. No.: **29/205,610**

(22) Filed: **May 18, 2004**

(30) **Foreign Application Priority Data**

Nov. 27, 2003 (JP) ..... D2003-035343  
Nov. 27, 2003 (JP) ..... D2003-035346

(51) **LOC (8) Cl.** ..... **08-99**

(52) **U.S. Cl.** ..... **D32/35**

(58) **Field of Classification Search** ..... D32/35;  
15/210.1, 231, 97.1  
See application file for complete search history.

(56) **References Cited**

U.S. PATENT DOCUMENTS

5,117,528 A \* 6/1992 Kanayama et al. .... 15/210.1  
D434,181 S \* 11/2000 Watanabe et al. .... D28/9  
D473,358 S \* 4/2003 Miller ..... D32/35

\* cited by examiner

*Primary Examiner*—Holly H. Baynham  
(74) *Attorney, Agent, or Firm*—SAIDMAN DesignLaw Group

(57) **CLAIM**

The ornamental design for an optical connector end-face cleaner, as shown and described.

**DESCRIPTION**

FIG. 1 is a perspective view of an optical connector end-face cleaner showing my design;  
FIG. 2 is a front view thereof;  
FIG. 3 is a rear view thereof;  
FIG. 4 is a right side view thereof;  
FIG. 5 is a left side view thereof;  
FIG. 6 is a top plan view thereof;  
FIG. 7 is a bottom view thereof;  
FIG. 8 is a front view thereof with its cap opened;  
FIG. 9 is a perspective view of a second embodiment of an optical connector end-face cleaner;  
FIG. 10 is a front view thereof;  
FIG. 11 is a rear view thereof;  
FIG. 12 is a right side view thereof;  
FIG. 13 is a left side view thereof;  
FIG. 14 is a top plan view thereof;  
FIG. 15 is a bottom view thereof;  
FIG. 16 is a front view thereof with its cleaning bar portion turned; and,  
FIG. 17 is a front view of a third embodiment of an optical connector end-face cleaner.

**1 Claim, 6 Drawing Sheets**

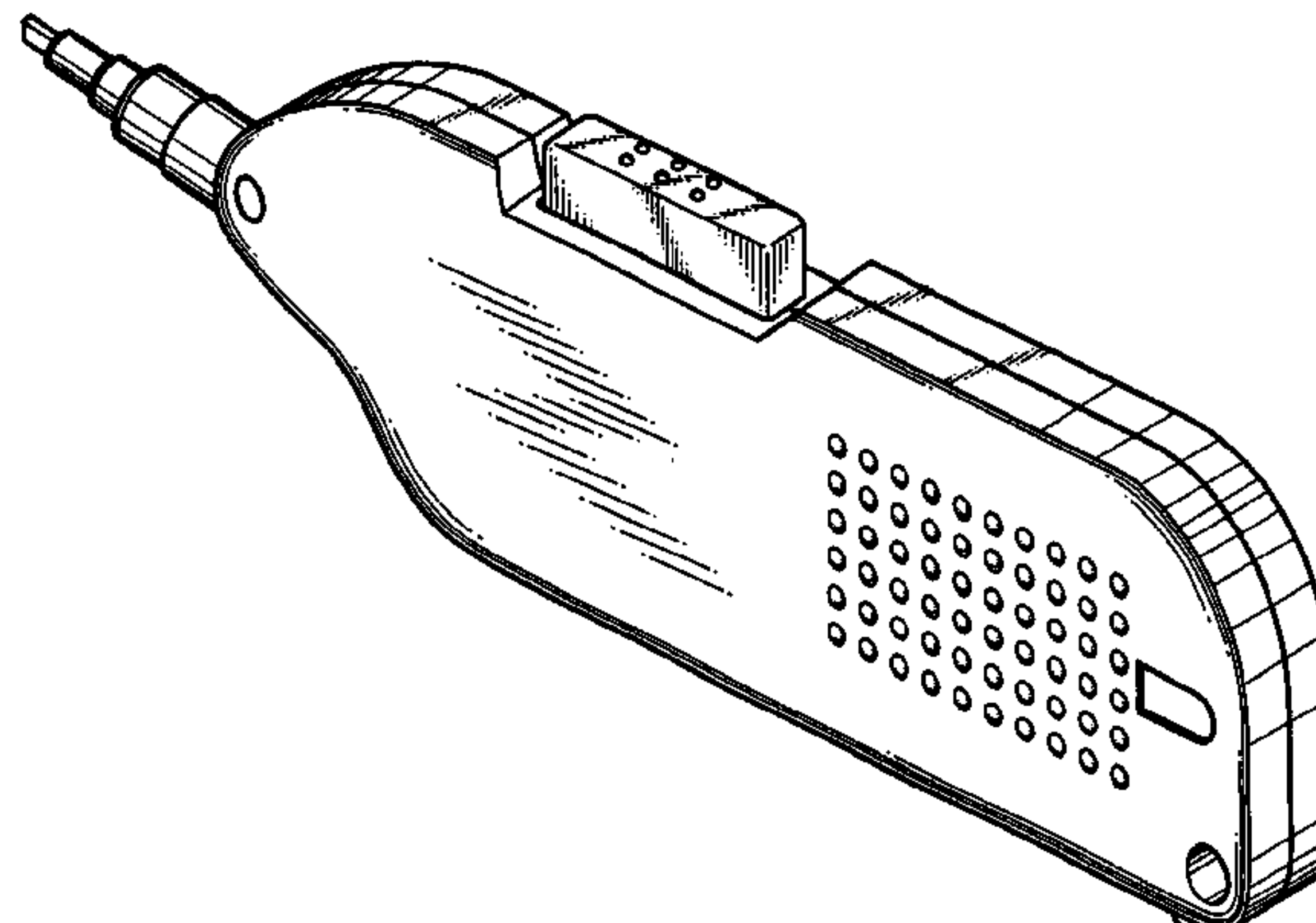
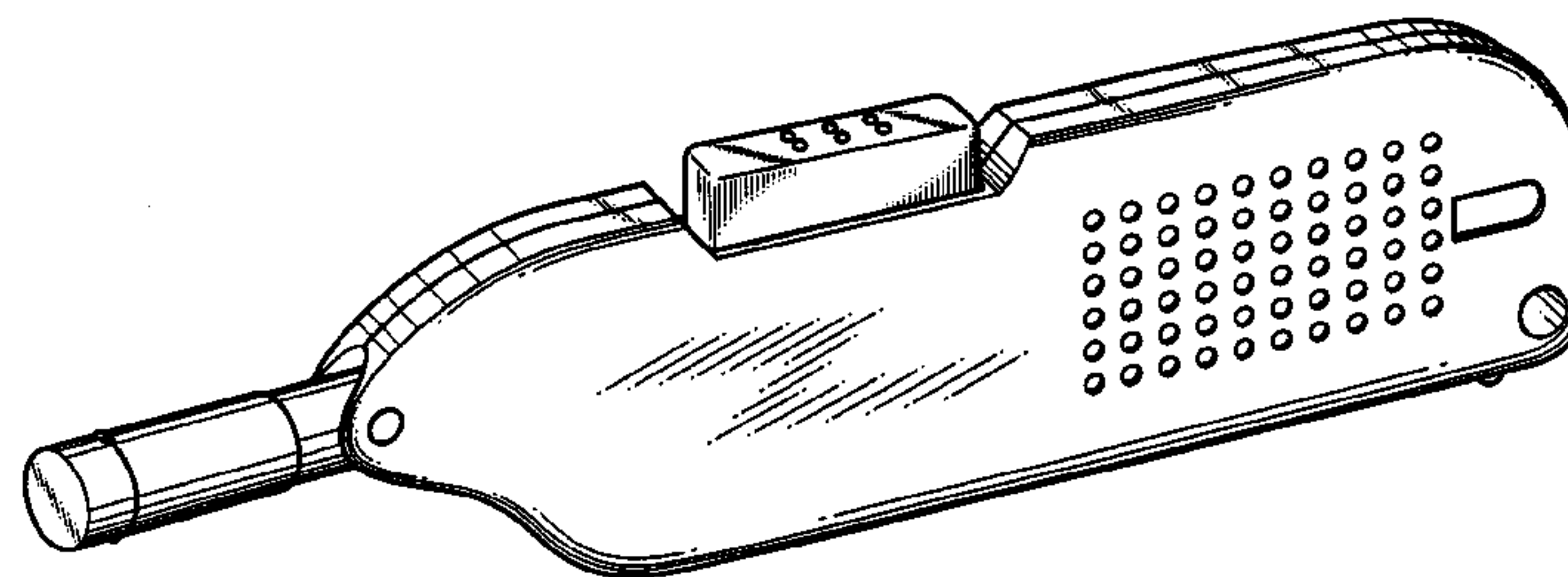

Fig.1

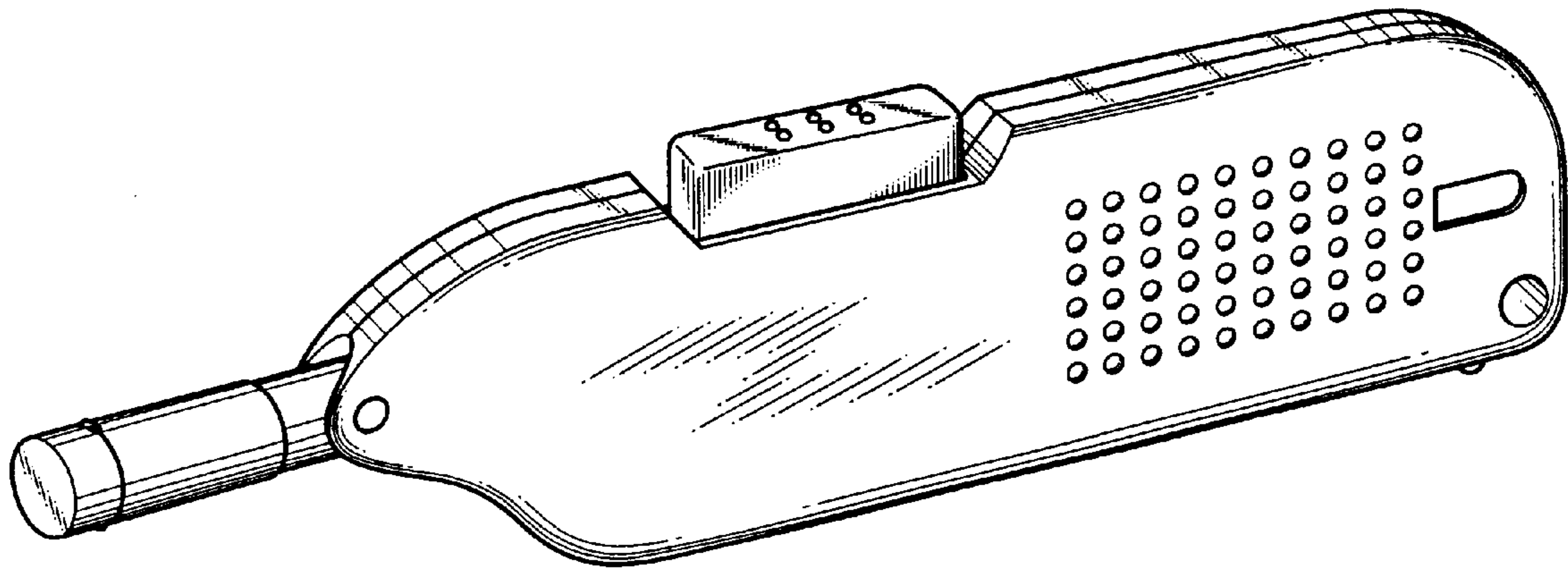

Fig.2

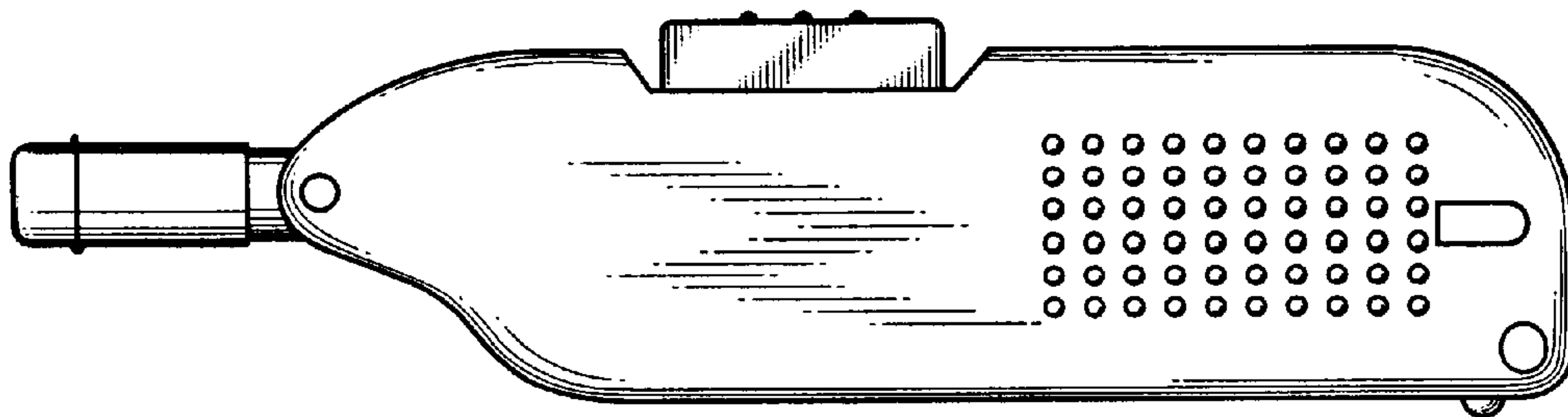

Fig.3

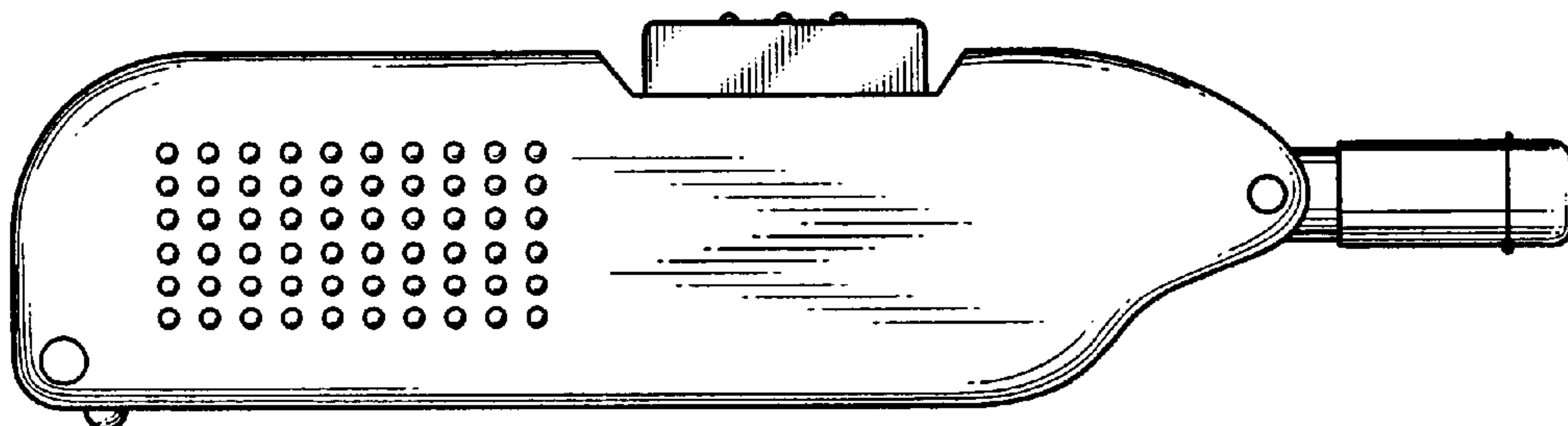

Fig.4

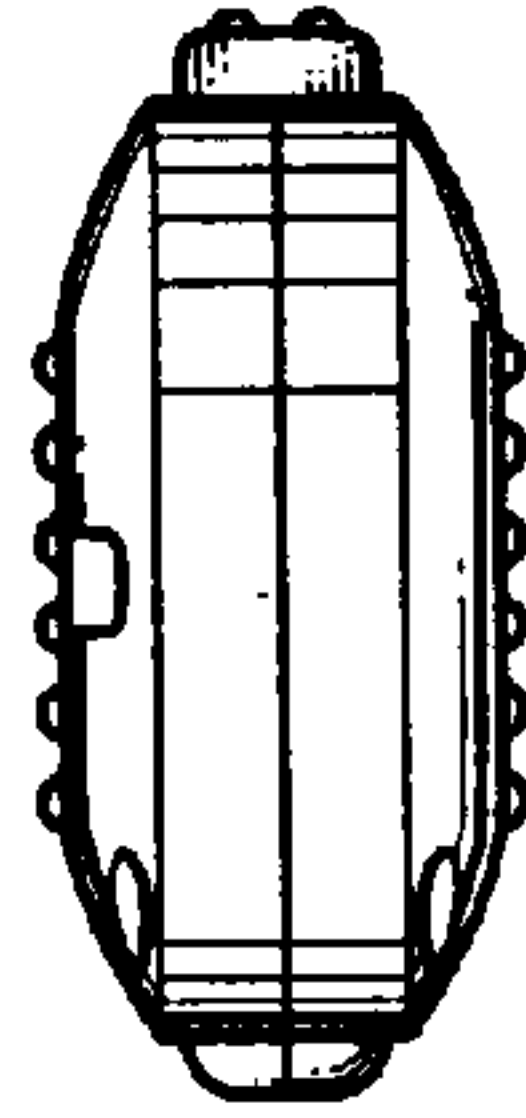

Fig.5

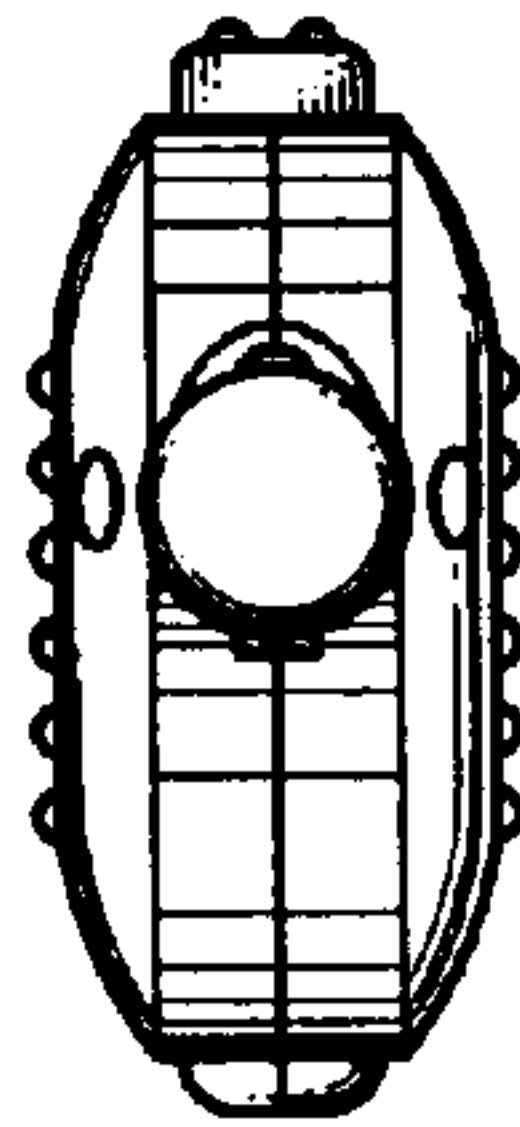

Fig.6

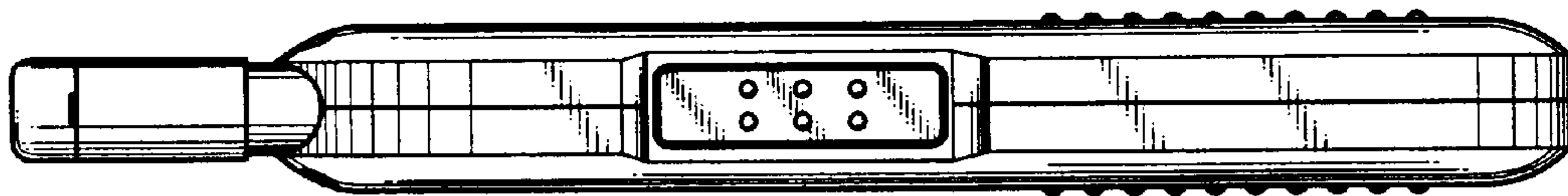

Fig.7

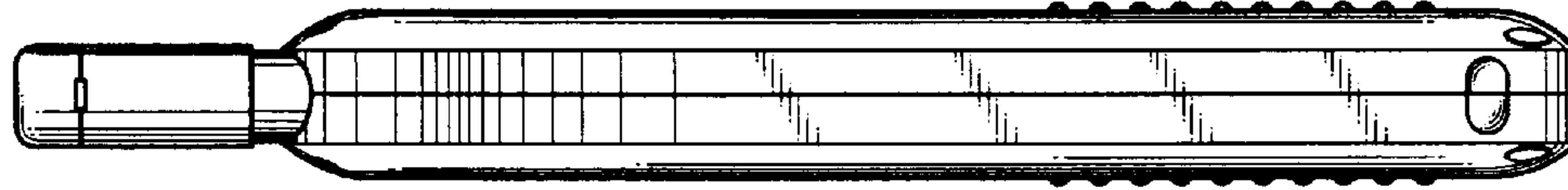

Fig.8

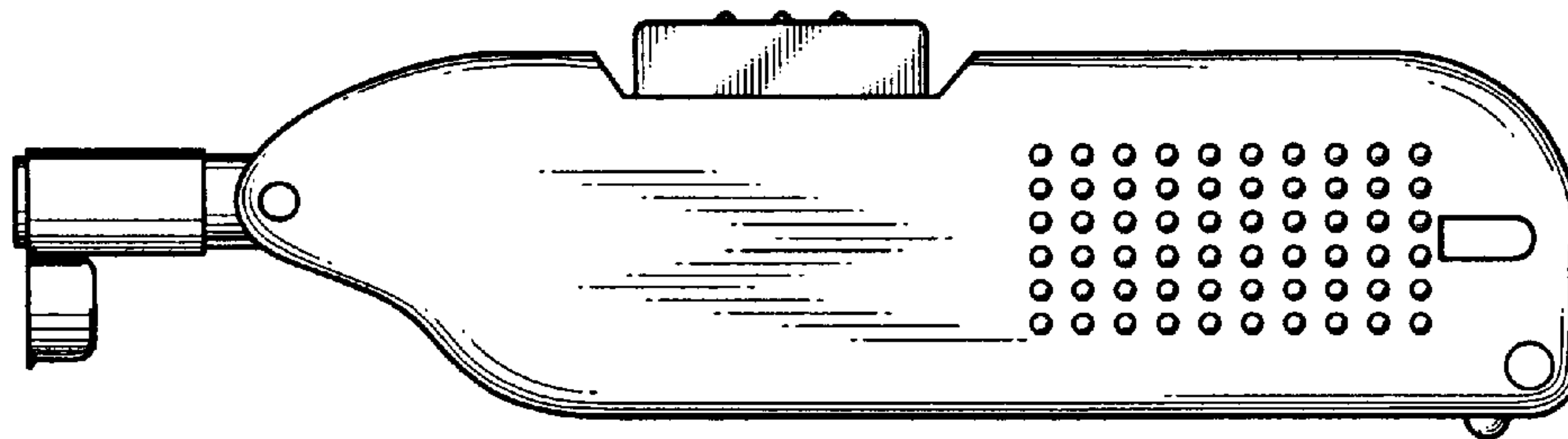

Fig.9

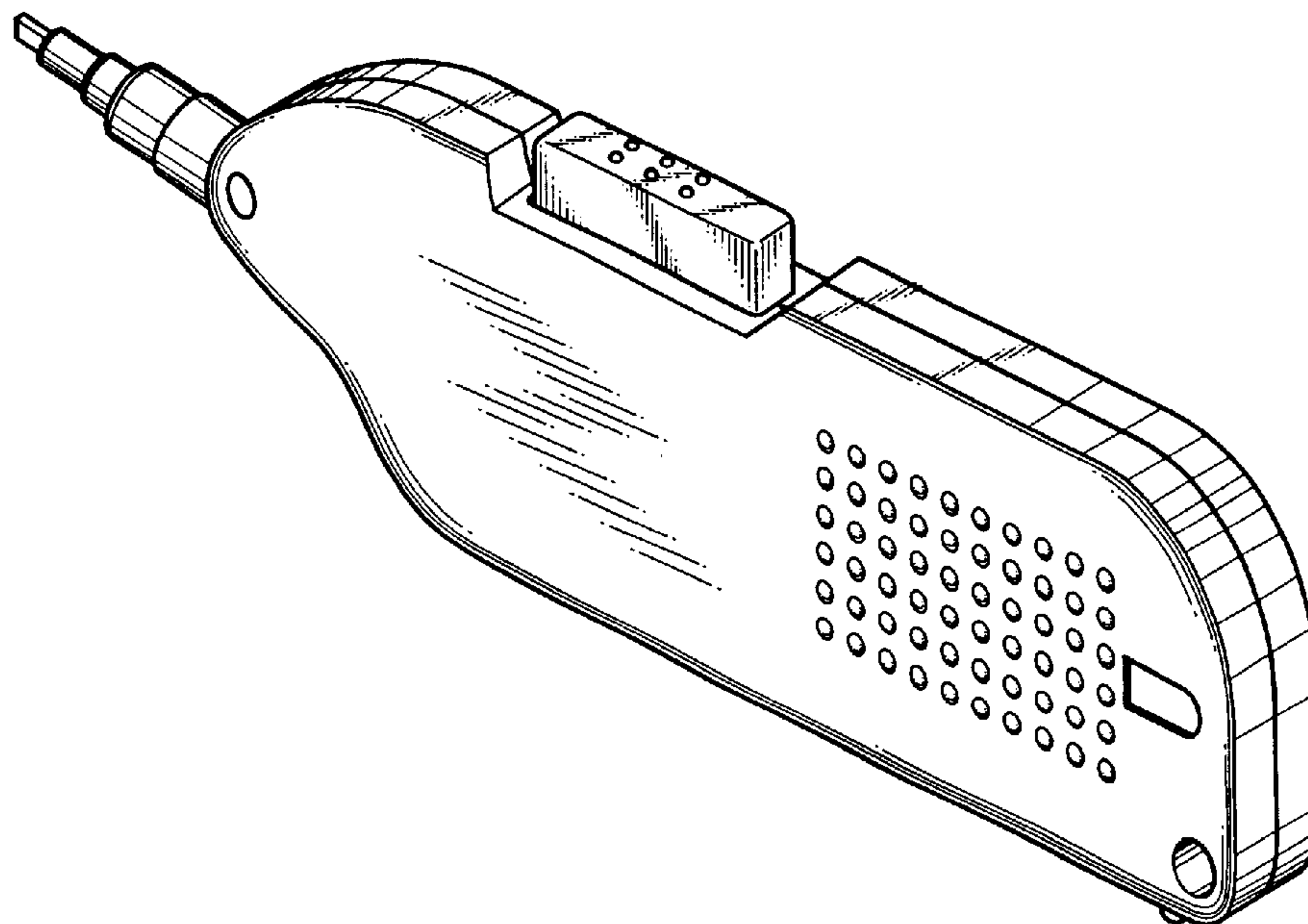

Fig. 10

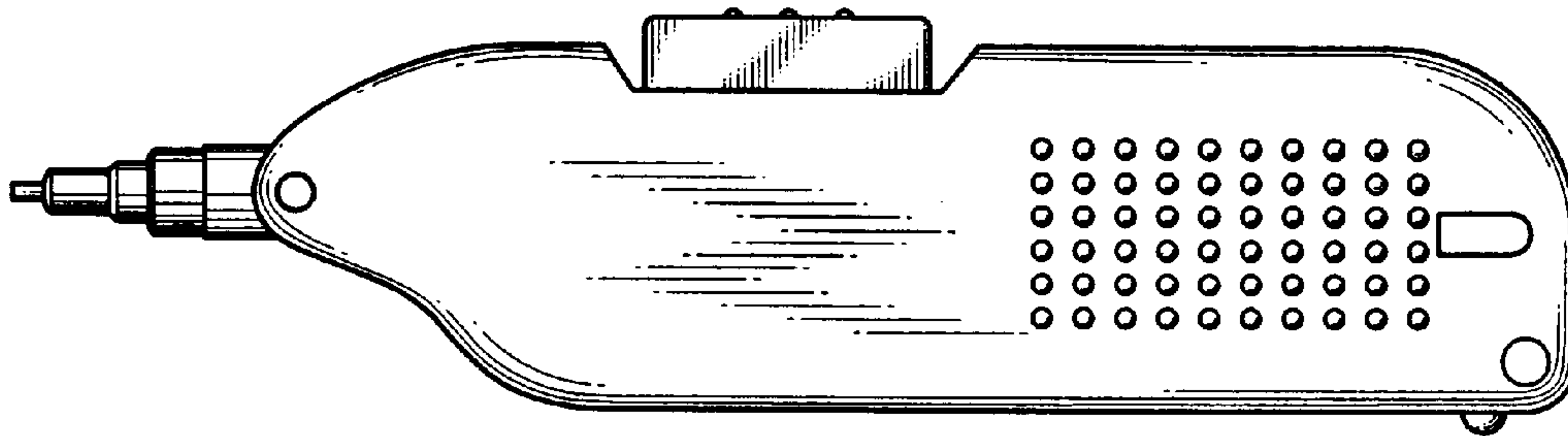

Fig. 11

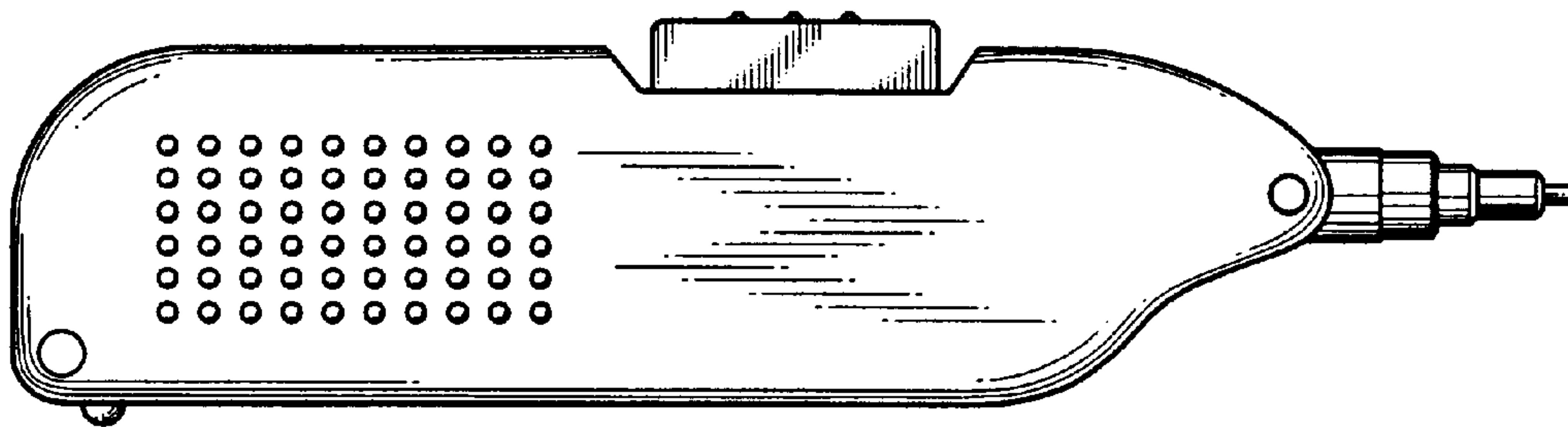

Fig. 12

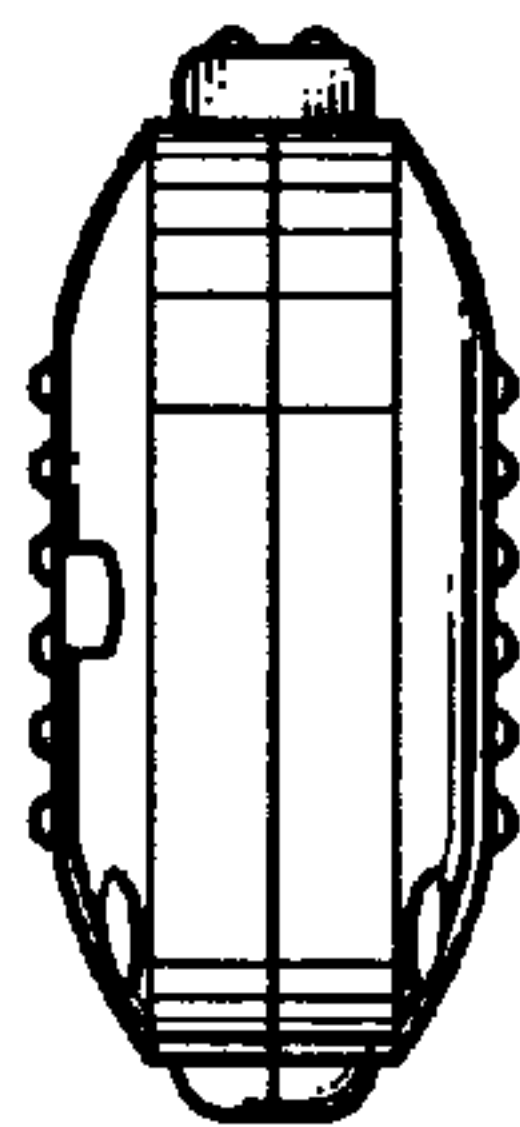



Fig.13

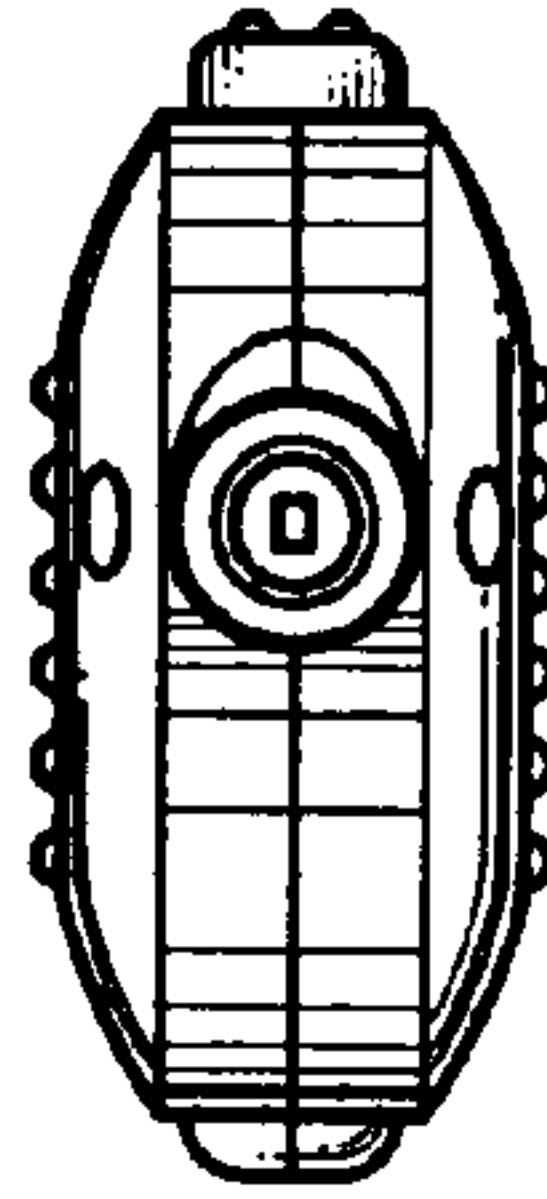

Fig.14

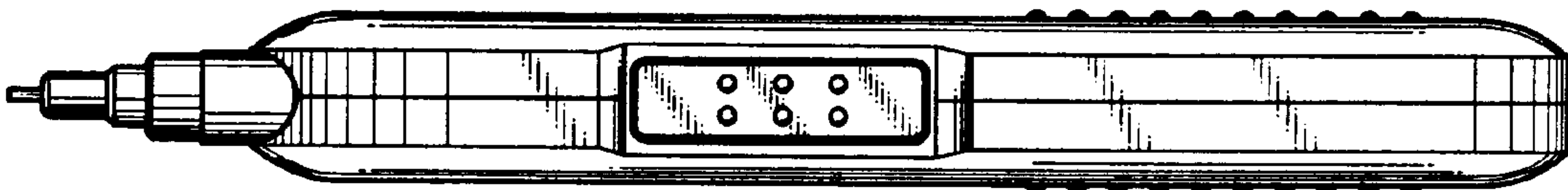

Fig.15

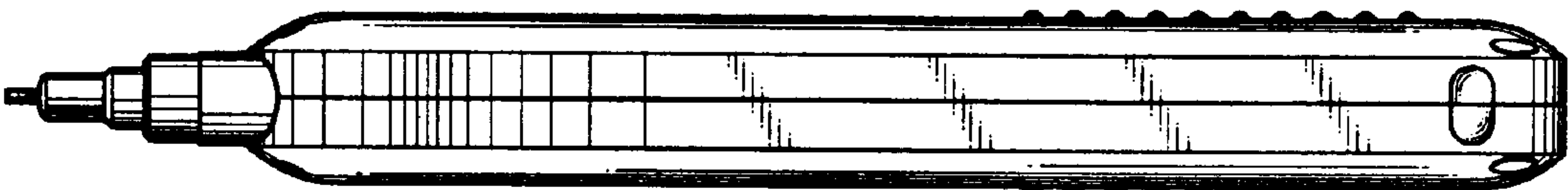

Fig.16

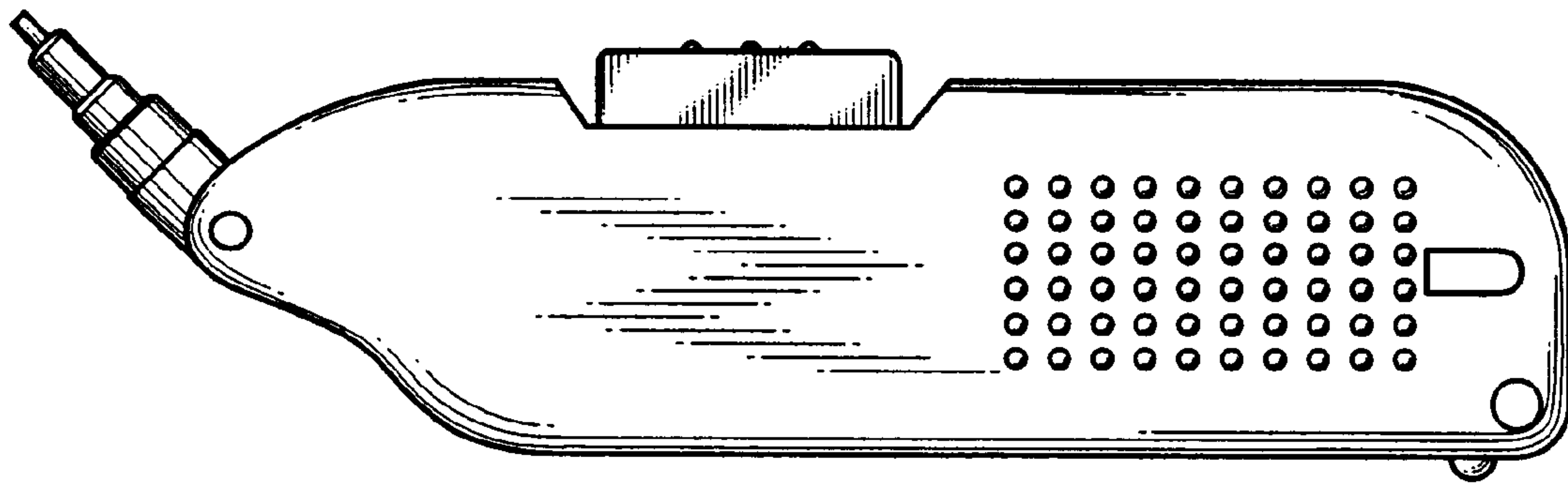

Fig.17

