



US00D525380S

(12) **United States Design Patent**
Gillis

(10) **Patent No.:** **US D525,380 S**

(45) **Date of Patent:** **** Jul. 18, 2006**

(54) **FLASHLIGHT**

(75) Inventor: **Matt J. Gillis**, Salt Lake City, UT (US)

(73) Assignee: **Construction Essentials**, Salt Lake City, UT (US)

(**) Term: **14 Years**

(21) Appl. No.: **29/229,479**

(22) Filed: **May 5, 2005**

(51) **LOC (8) Cl.** **26-02**

(52) **U.S. Cl.** **D26/49**

(58) **Field of Classification Search** D26/37-50;
362/157, 158, 171-174, 183-208

See application file for complete search history.

(56) **References Cited**

U.S. PATENT DOCUMENTS

3,099,402 A	7/1963	Speck	
4,760,504 A	7/1988	Schaller et al.	
5,552,973 A	9/1996	Hsu	
5,975,714 A	11/1999	Vetorino et al.	
D420,457 S	* 2/2000	Breit	D26/49
D431,874 S	* 10/2000	Burns	D26/49
D433,523 S	* 11/2000	Poon	D26/49
6,220,719 B1	4/2001	Vetorino et al.	
D451,224 S	* 11/2001	Yang	D26/49
D468,852 S	* 1/2003	Mah	D26/49
6,536,912 B1	3/2003	Parker	

6,729,744 B1	5/2004	Mah
6,802,621 B1	10/2004	Adeler
6,808,288 B1	10/2004	Mah
2004/0008510 A1	1/2004	Mah
2004/0057233 A1	3/2004	Sharrah et al.
2004/0080933 A1	4/2004	Cheetham

* cited by examiner

Primary Examiner—Marcus A. Jackson

(74) *Attorney, Agent, or Firm*—Thorpe North & Western LLP

(57) **CLAIM**

The ornamental design for a flashlight, as shown and described.

DESCRIPTION

FIG. 1 is a side view of the flashlight in accordance with my invention;

FIG. 2 is a perspective side view thereof;

FIG. 3 is an opposite side view thereof;

FIG. 4 is a back end view thereof;

FIG. 5 is a front end view thereof;

FIG. 6 is a side view of the flashlight in full detail;

FIG. 7 is a perspective side view in full detail;

FIG. 8 is an opposite side view in full detail;

FIG. 9 is a back end view in full detail; and,

FIG. 10 is a front end view in full detail.

1 Claim, 4 Drawing Sheets

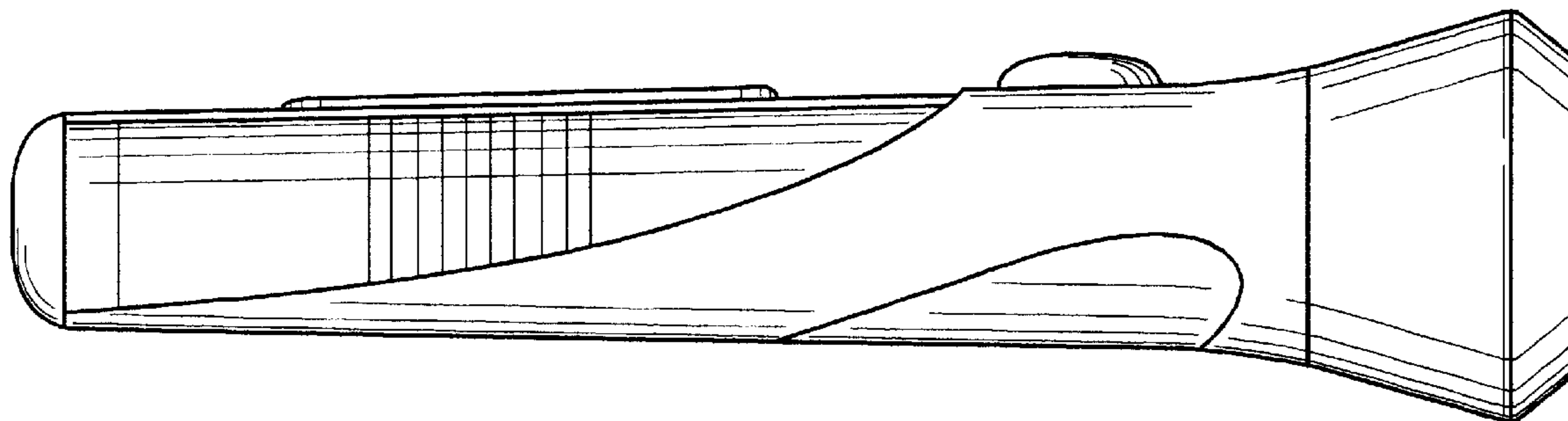

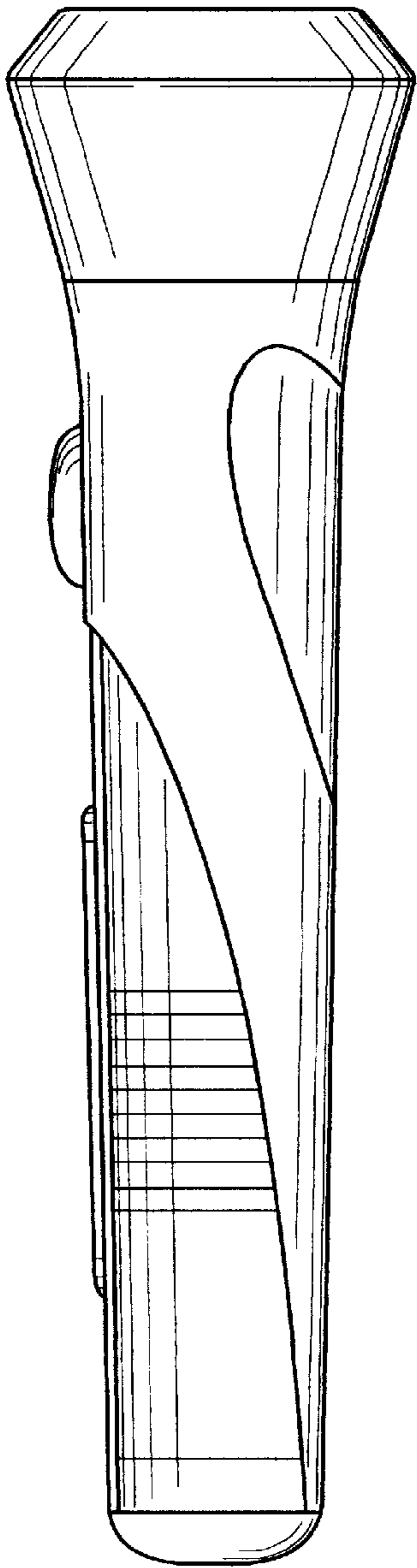

FIG. 1

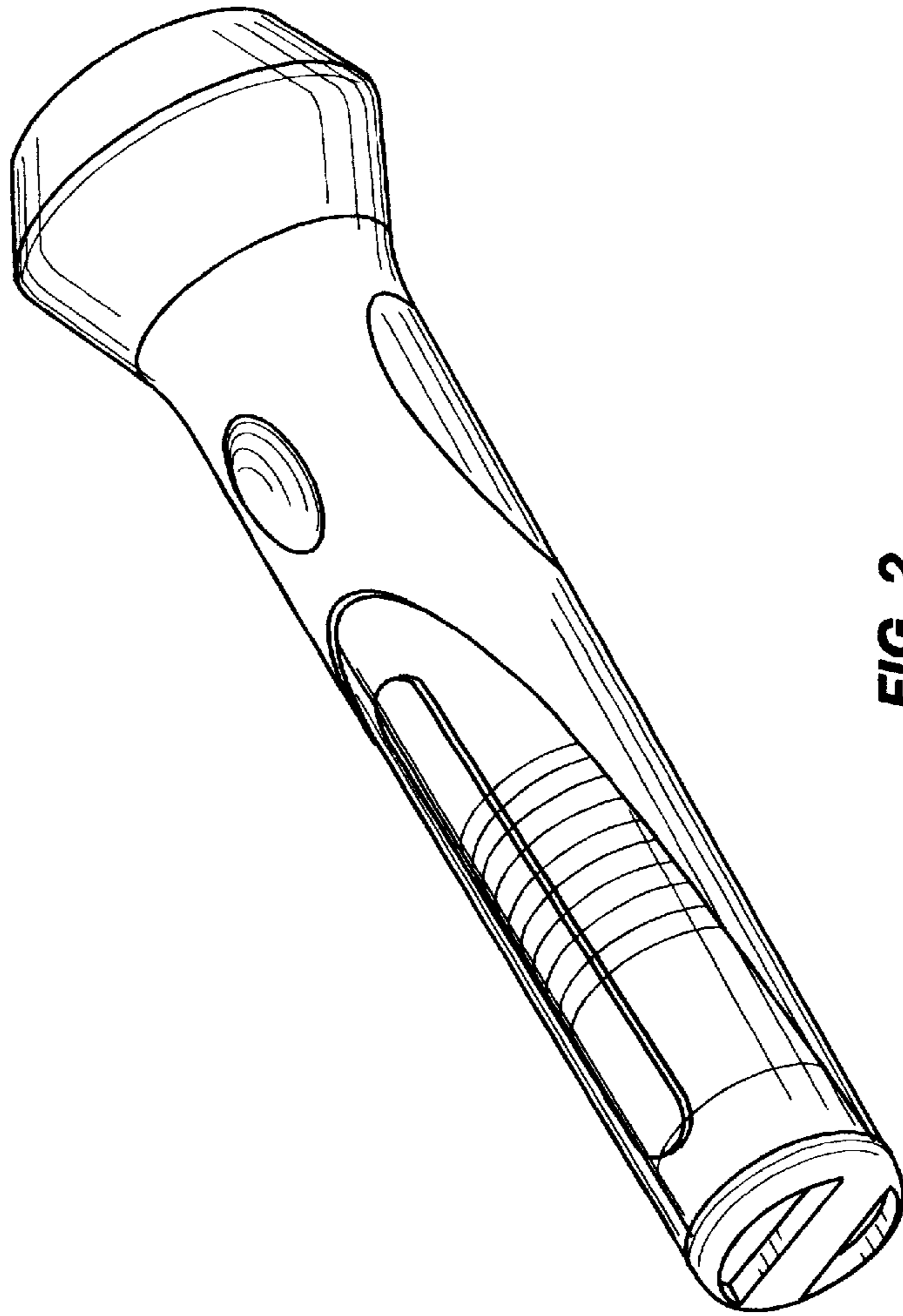

FIG. 2

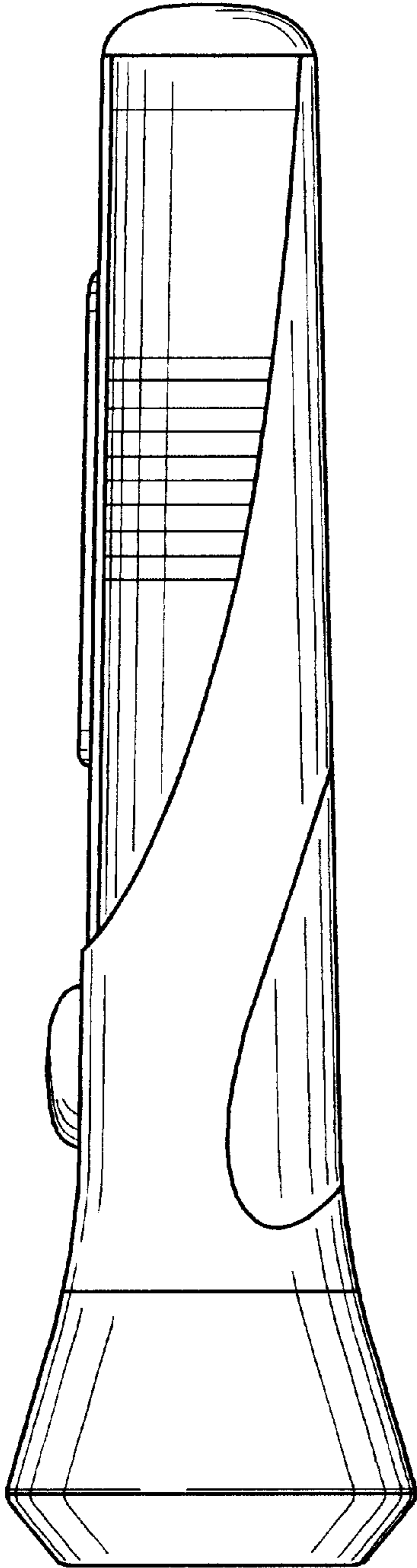

FIG. 3

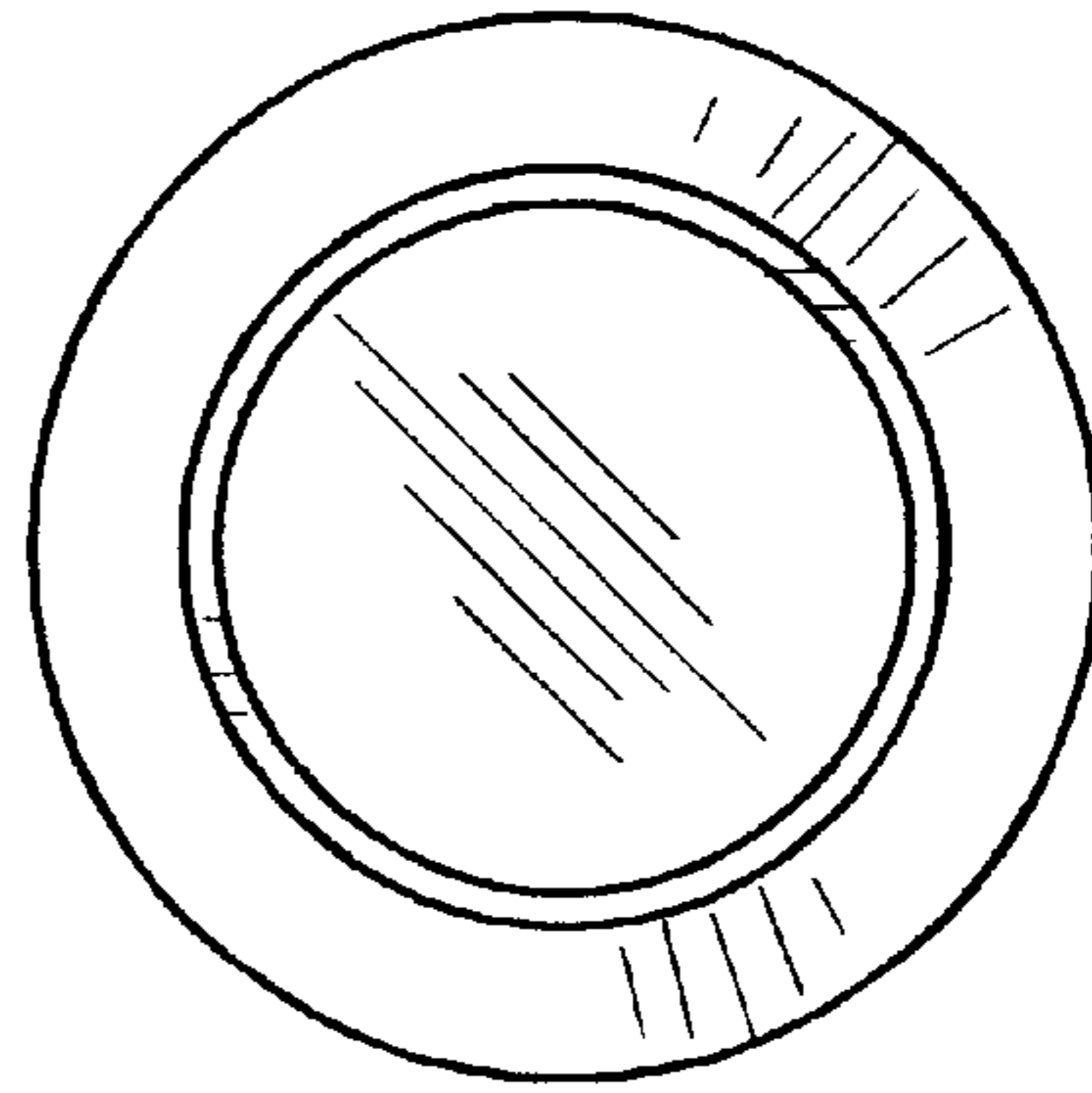

FIG. 5

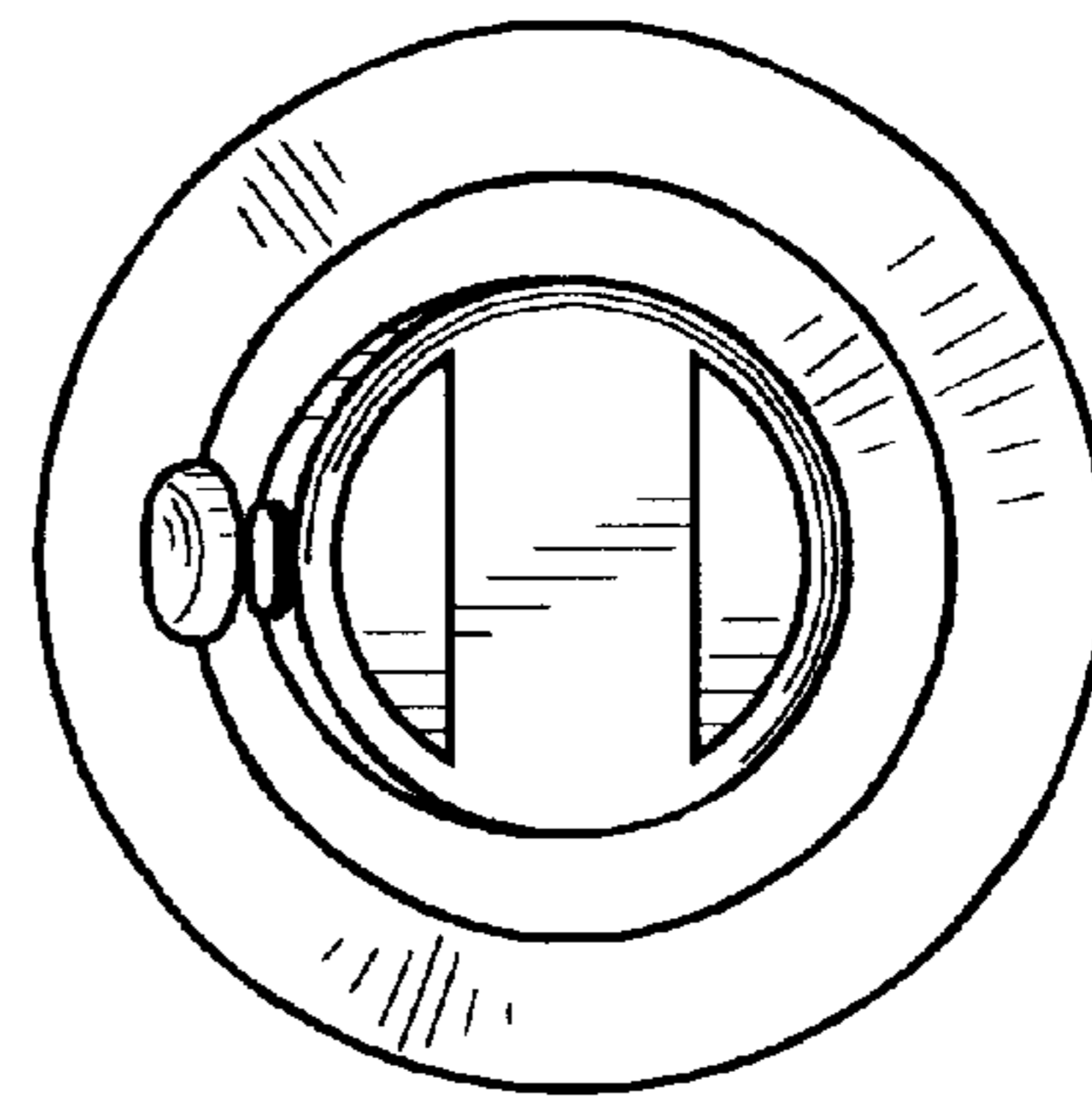

FIG. 4

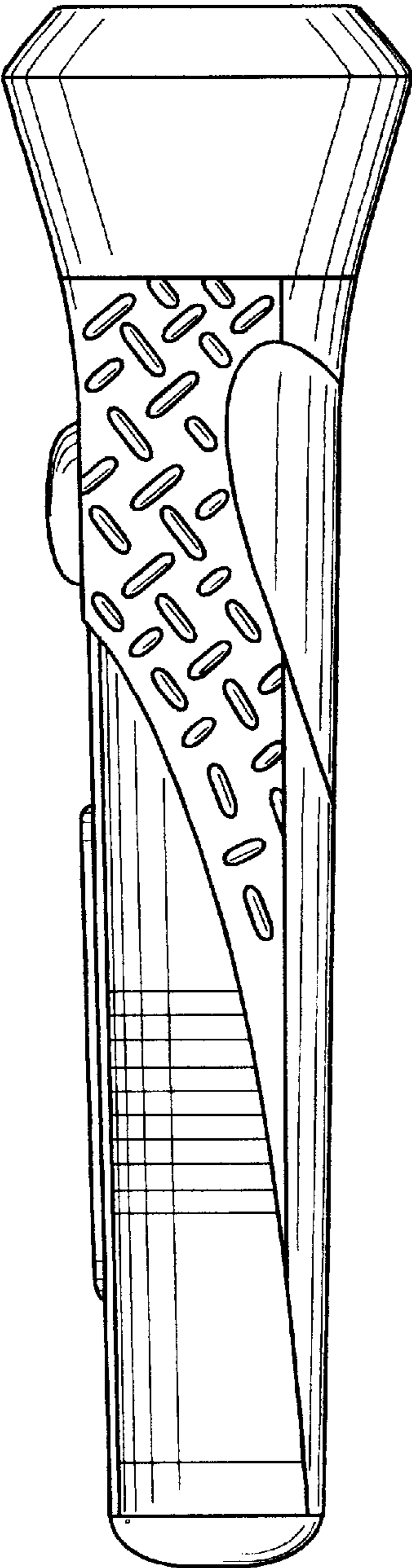

FIG. 6

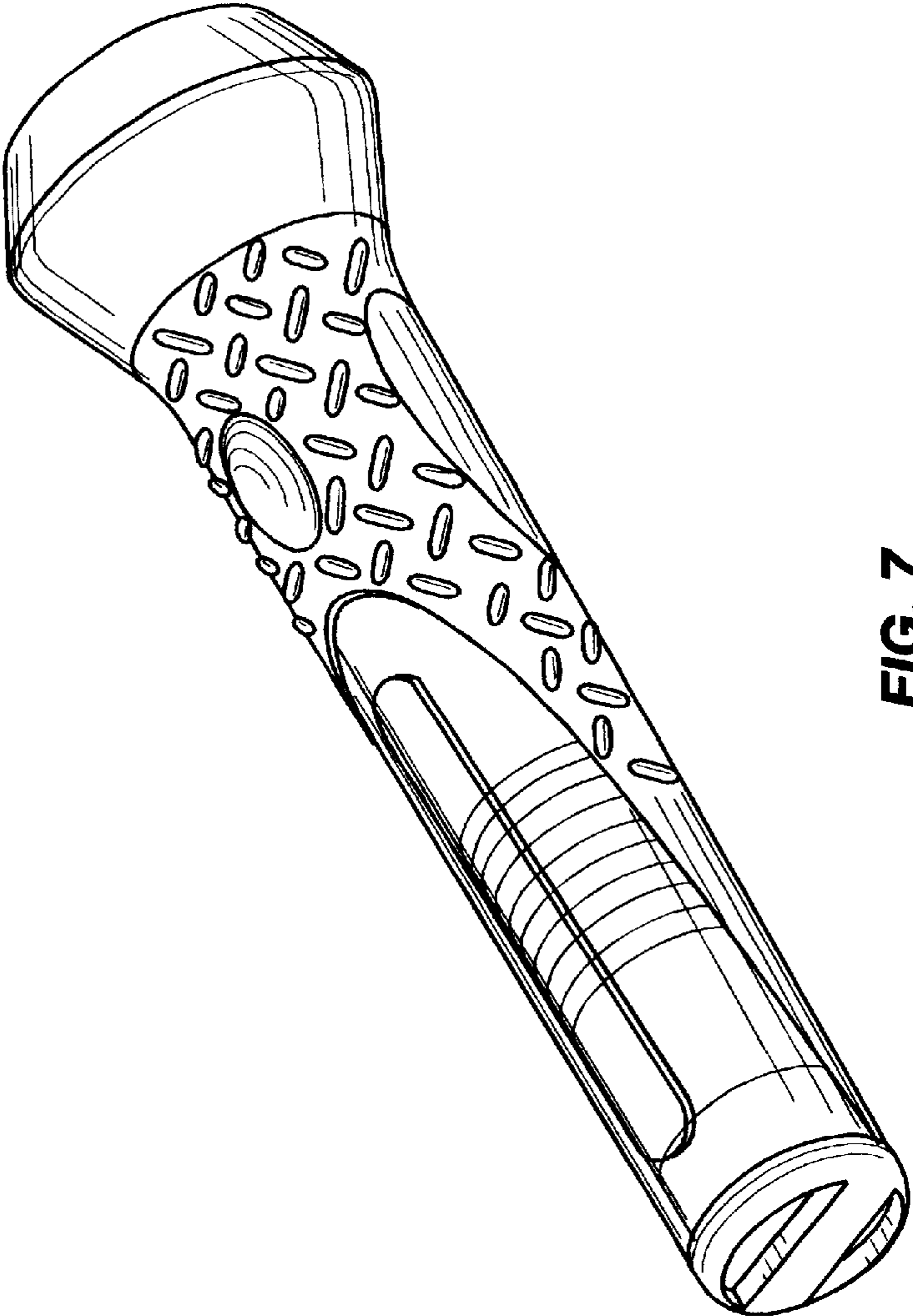

FIG. 7

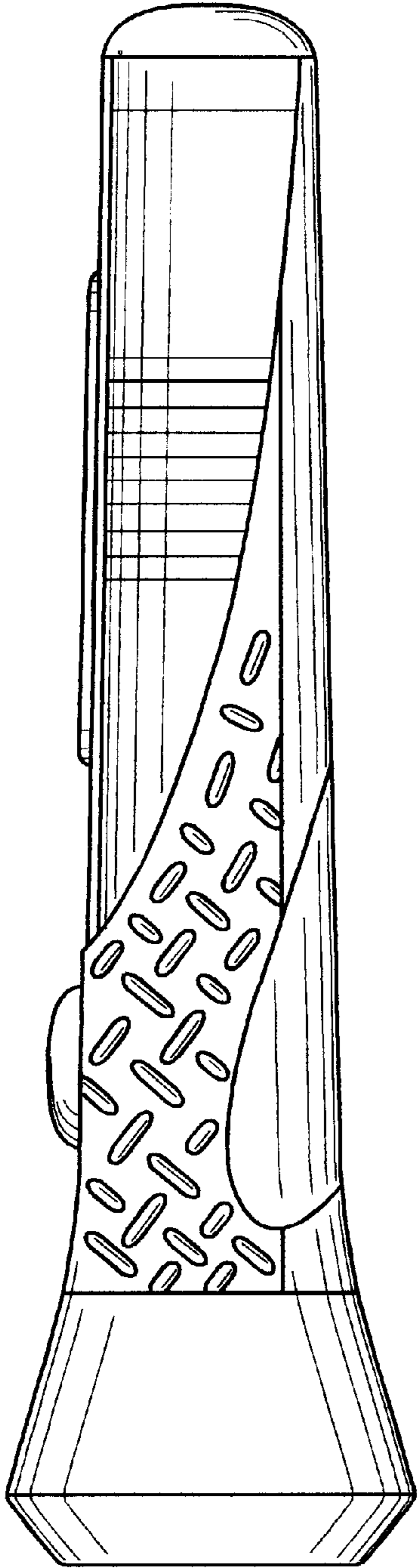

FIG. 8

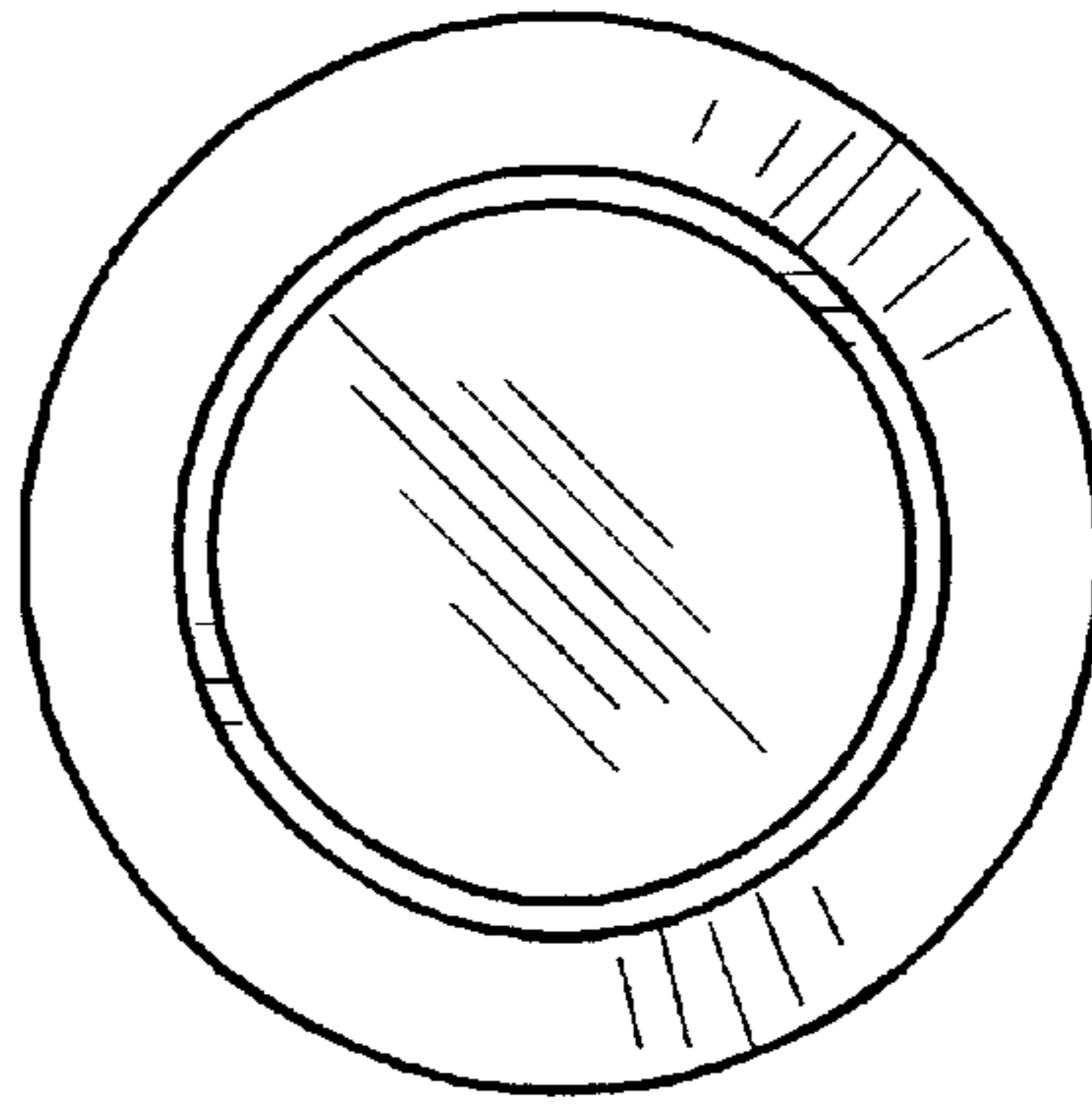

FIG. 10

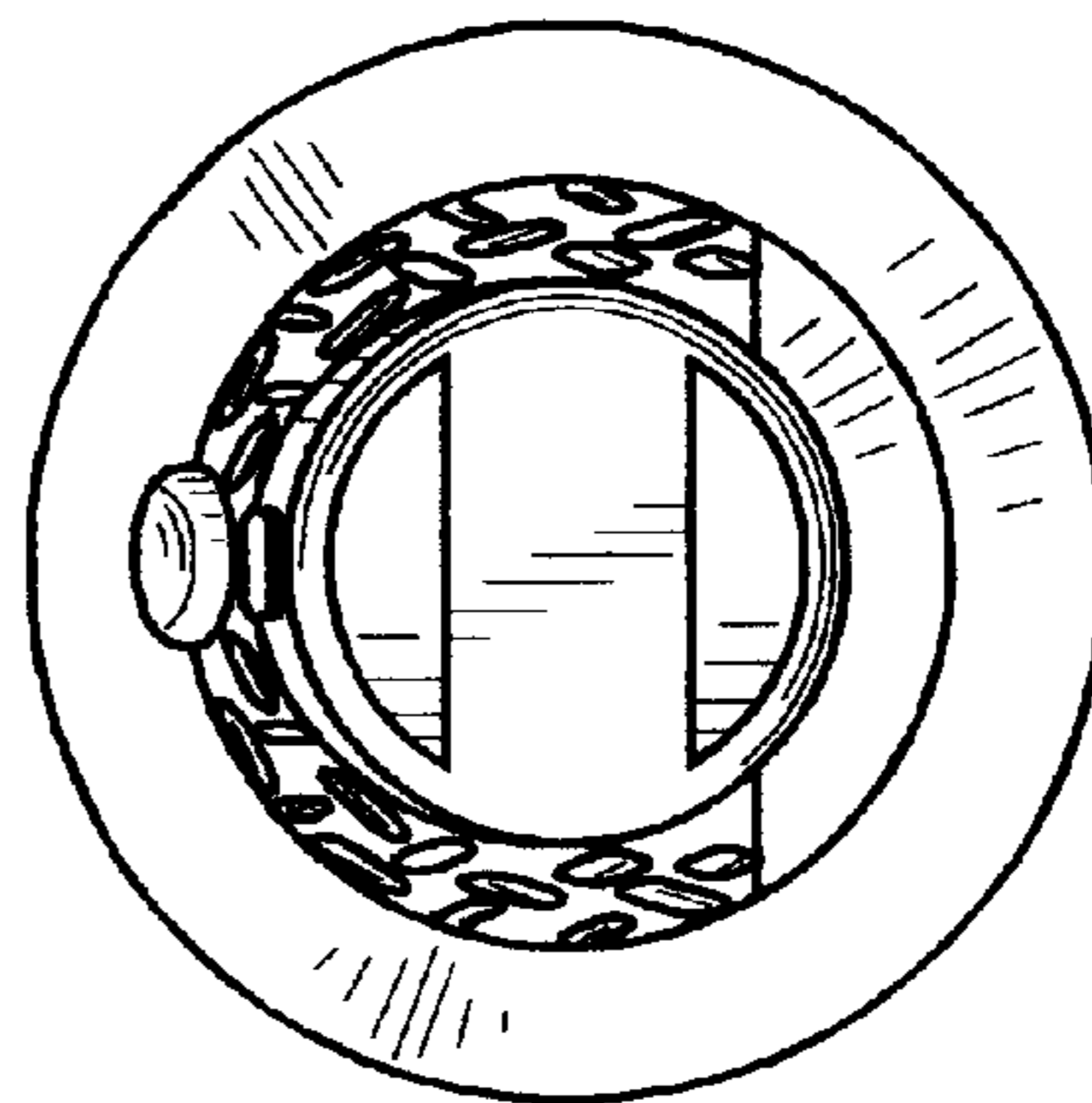

FIG. 9