



US00D525338S

(12) **United States Design Patent**  
**Larson**

(10) **Patent No.:** **US D525,338 S**  
(45) **Date of Patent:** **\*\* Jul. 18, 2006**

(54) **SCENT DISPENSING LURE BODIES HAVING AN INTERIOR CHAMBER**

(76) Inventor: **Erik Larson**, 1170 13<sup>th</sup> St., N.E., Salem, OR (US) 97301

(\*\*) Term: **14 Years**

(21) Appl. No.: **29/229,419**

(22) Filed: **May 6, 2006**

(51) **LOC (8) Cl.** ..... **22-05**

(52) **U.S. Cl.** ..... **D22/126**

(58) **Field of Classification Search** ..... D22/126-133;  
43/42.06, 42.24, 42.26, 46, 42.48, 37, 42.09,  
43/42.4, 42.39

See application file for complete search history.

(56) **References Cited**

**U.S. PATENT DOCUMENTS**

2,791,058 A 5/1957 Bettini ..... 43/42.06

(Continued)

*Primary Examiner*—Catherine R. Oliver

(74) *Attorney, Agent, or Firm*—Kolisch Hartwell, P.C.

(57) **CLAIM**

I claim the ornamental design for scent dispensing lure bodies having an interior chamber, as shown and described.

**DESCRIPTION**

FIG. 1 is a perspective view of a lure body according to the present disclosure.

FIG. 2 is a front elevation view of the lure body shown in FIG. 1.

FIG. 3 is a rear elevation view of the lure body shown in FIG. 1.

FIG. 4 is a top view of the lure body shown in FIG. 1.

FIG. 5 is a right side view of the lure body shown in FIG. 1.

FIG. 6 is a bottom view of the lure body shown in FIG. 1.

FIG. 7 is an exploded view of the lure body shown in FIG. 1.

FIG. 8 is a perspective view of another lure body according to the present disclosure.

FIG. 9 is a front elevation view of the lure body in FIG. 8.

FIG. 10 is a rear elevation view of the lure body in FIG. 8.

FIG. 11 is a top view of the lure body in FIG. 8.

FIG. 12 is a right side view of the lure body shown in FIG. 8.

FIG. 13 is a bottom view of the lure body shown in FIG. 8.

FIG. 14 is an exploded view of the lure body shown in FIG. 8.

FIG. 15 is a perspective view of another lure body according to the present disclosure.

FIG. 16 is a front elevation view of the lure body in FIG. 15.

FIG. 17 is a rear elevation view of the lure body in FIG. 15.

FIG. 18 is a top view of the lure body in FIG. 15.

FIG. 19 is a right side view of the lure body shown in FIG. 15.

FIG. 20 is a bottom view of the lure body shown in FIG. 15.

FIG. 21 is an exploded view of the lure body shown in FIG. 15.

FIG. 22 is a perspective view of another lure body according to the present disclosure.

FIG. 23 is a front elevation view of the lure body in FIG. 22.

FIG. 24 is a rear elevation view of the lure body in FIG. 22.

FIG. 25 is a top view of the lure body in FIG. 22.

FIG. 26 is right side view of the lure body shown in FIG. 22.

FIG. 27 is a bottom view of the lure body shown in FIG. 22; and,

FIG. 28 is an exploded view of the lure body shown in FIG. 22.

The broken line(s) shown in the drawings are for illustrative purposes only and form no part of the claimed design.

The left side of the design is a mirror image of the right side, so the left view has been omitted.

The stippling and shading lines shown in the drawing(s) represent the approximate three-dimensional contour of the design, and are not intended to indicate surface decoration. Portions of the scent dispensing lure bodies having an interior chamber that are not shown in the drawing(s) form no part of the claimed design.

**1 Claim, 12 Drawing Sheets**

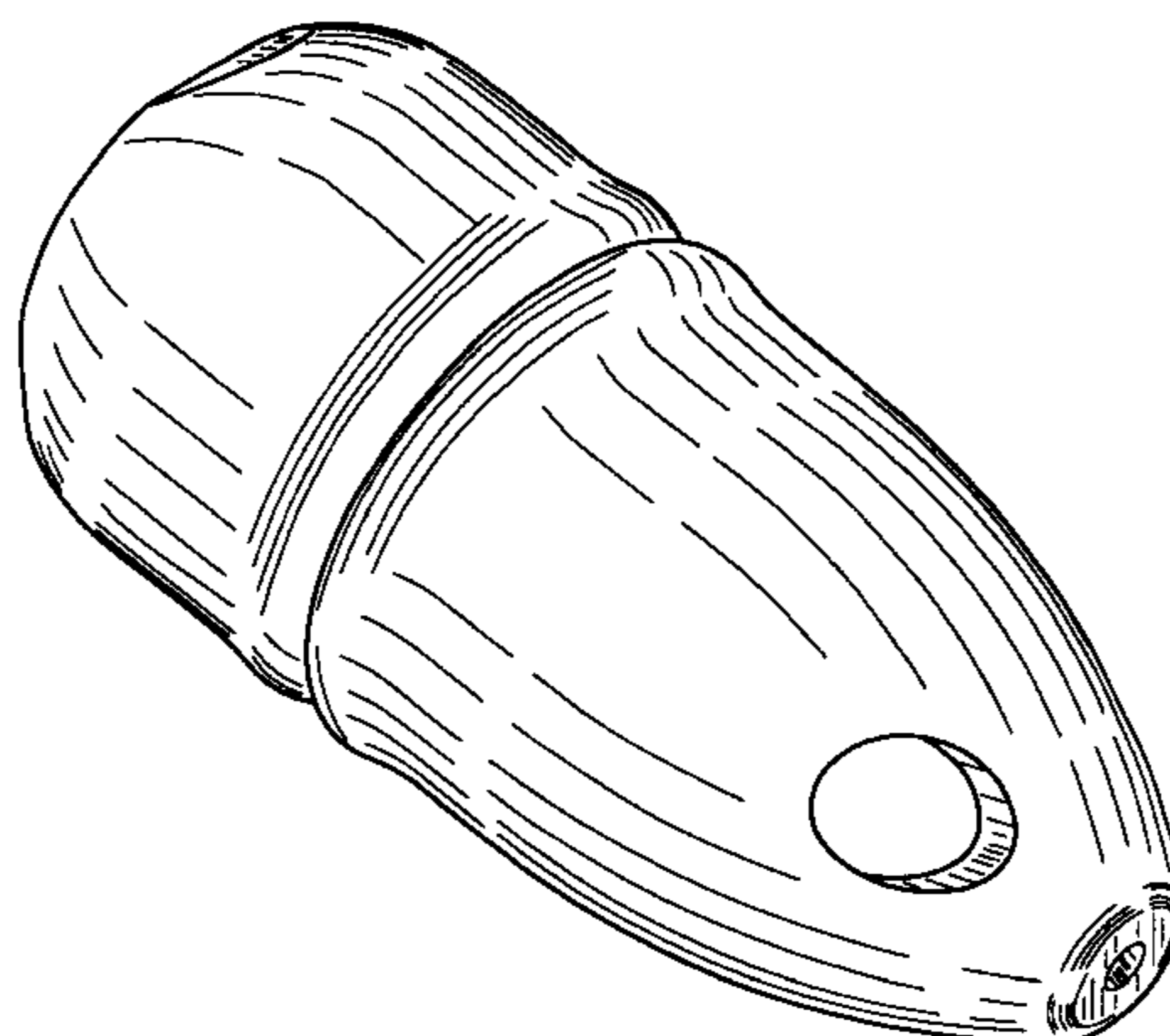

# US D525,338 S

Page 2

---

U.S. PATENT DOCUMENTS			
2,922,246 A	1/1960	Mileschuk .....	43/42.06
2,983,065 A	5/1961	Ferguson et al. ....	43/42.09
2,994,982 A	8/1961	Murawski .....	43/35
3,505,754 A	4/1970	Lawlor .....	43/42.22
3,654,724 A	4/1972	Charron .....	43/42.06
3,835,572 A	9/1974	Mounsey .....	43/42.06
3,916,556 A	11/1975	Armanno .....	43/42.06
4,133,134 A	1/1979	Cheng .....	43/42.06
4,205,476 A	6/1980	Hsu .....	43/42.06
4,267,658 A	5/1981	Brown et al. ....	43/42.06
4,520,588 A	6/1985	Hindemyer .....	43/42.06
4,676,020 A	6/1987	Taylor et al. ....	43/42.02
4,742,638 A	5/1988	Vobejda .....	43/42.06
4,777,757 A	10/1988	de Marees van Swinderen .....	43/41
5,172,510 A	12/1992	Lovell, Jr. ....	43/42.36
5,224,285 A	7/1993	Kamin et al. ....	43/42.06
5,638,630 A	6/1997	Volaski .....	43/41
6,354,037 B1 *	3/2002	Coppola, Jr. ....	43/42.06
6,412,214 B1	7/2002	Sebastiani .....	43/42.06
D461,218 S *	8/2002	Bambacigno .....	D22/126
6,588,138 B1	7/2003	Gilbert .....	43/42.06
6,668,482 B1 *	12/2003	Ruffin et al. ....	43/42.06
6,779,293 B1	8/2004	Rice .....	43/42.06
D513,780 S *	1/2006	Jakeman et al. ....	D22/126
2004/0216357 A1	11/2004	Bobrowski .....	43/42.06

\* cited by examiner

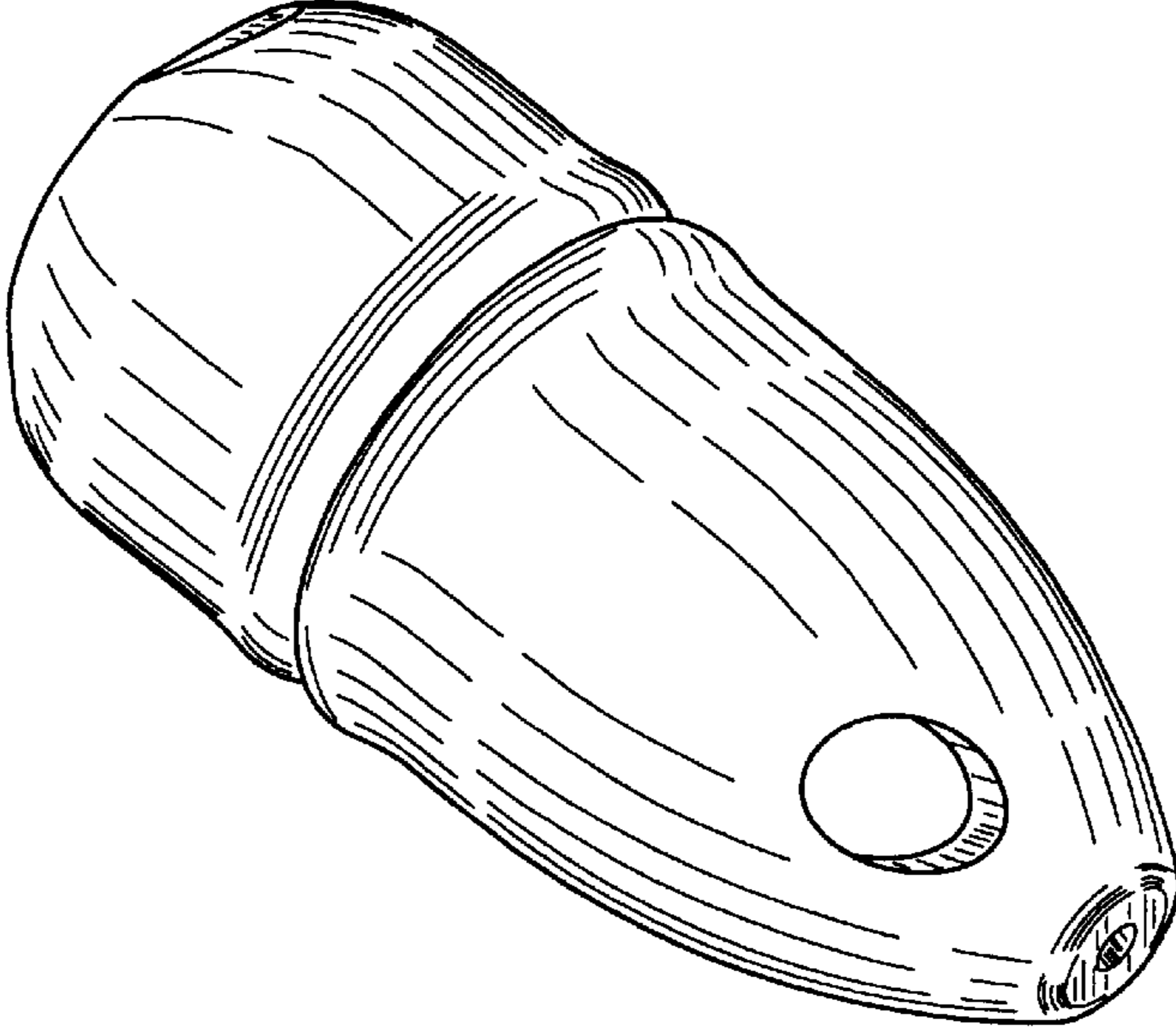

FIG. 1

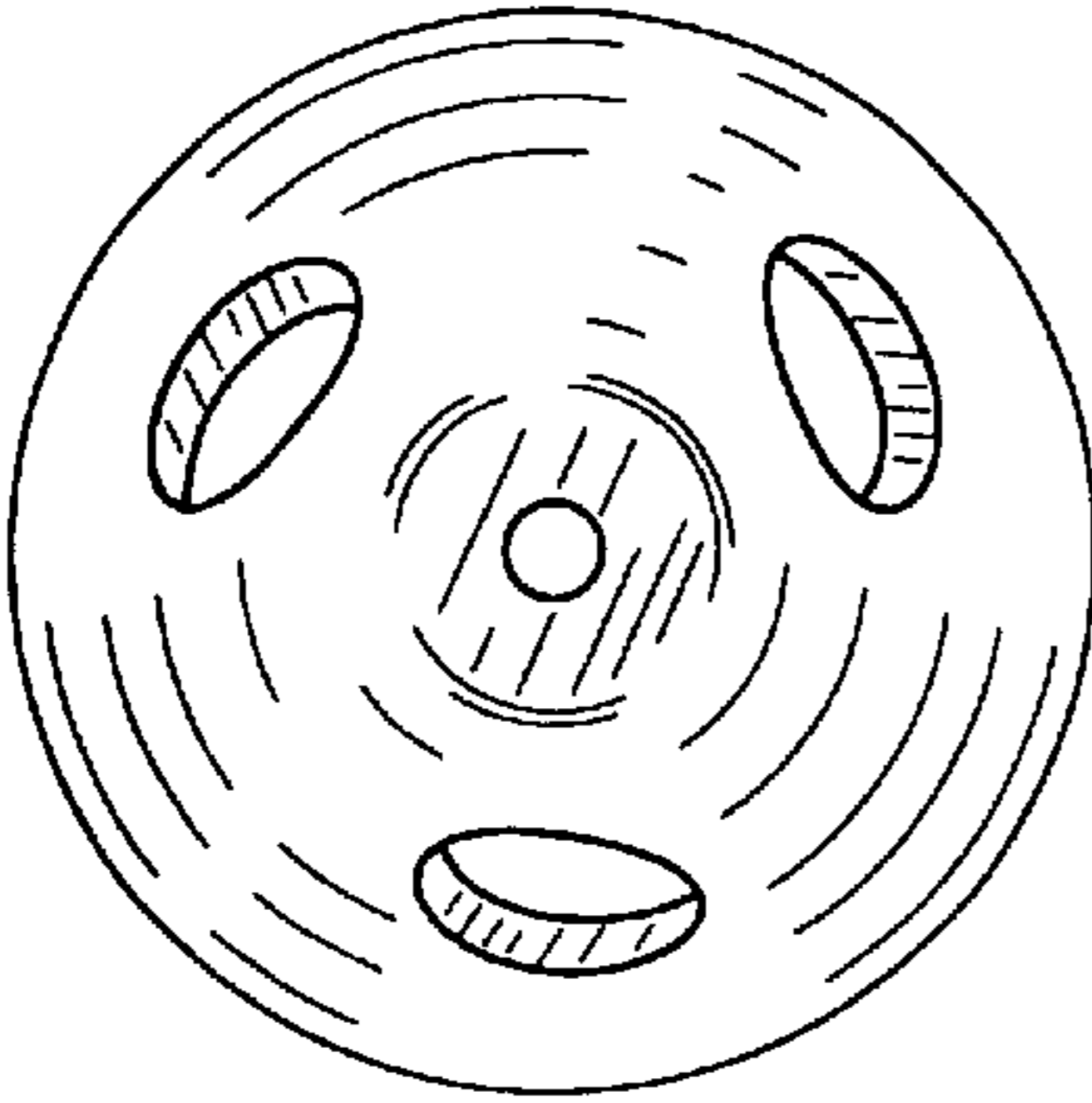

FIG. 2

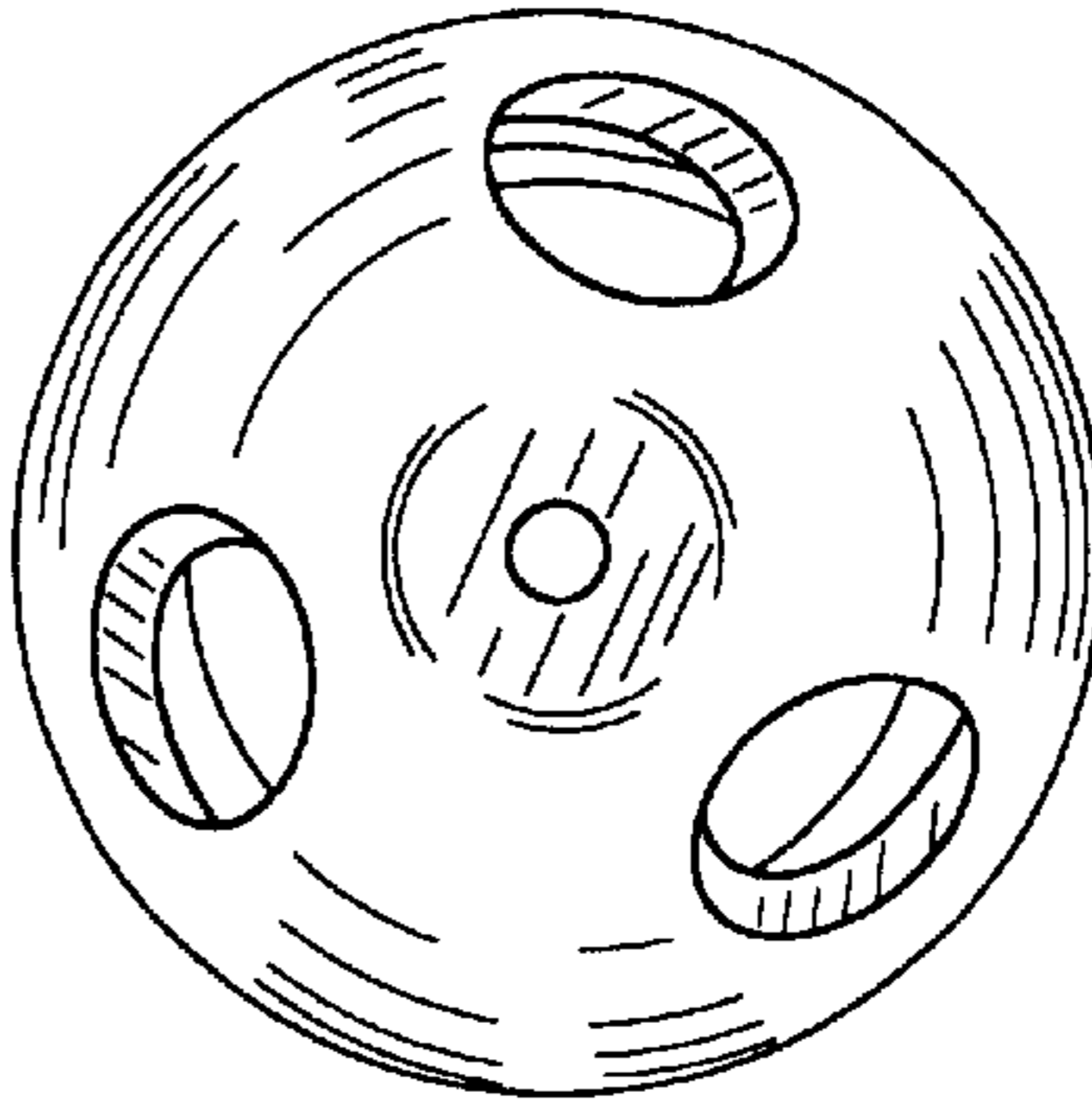

FIG. 3

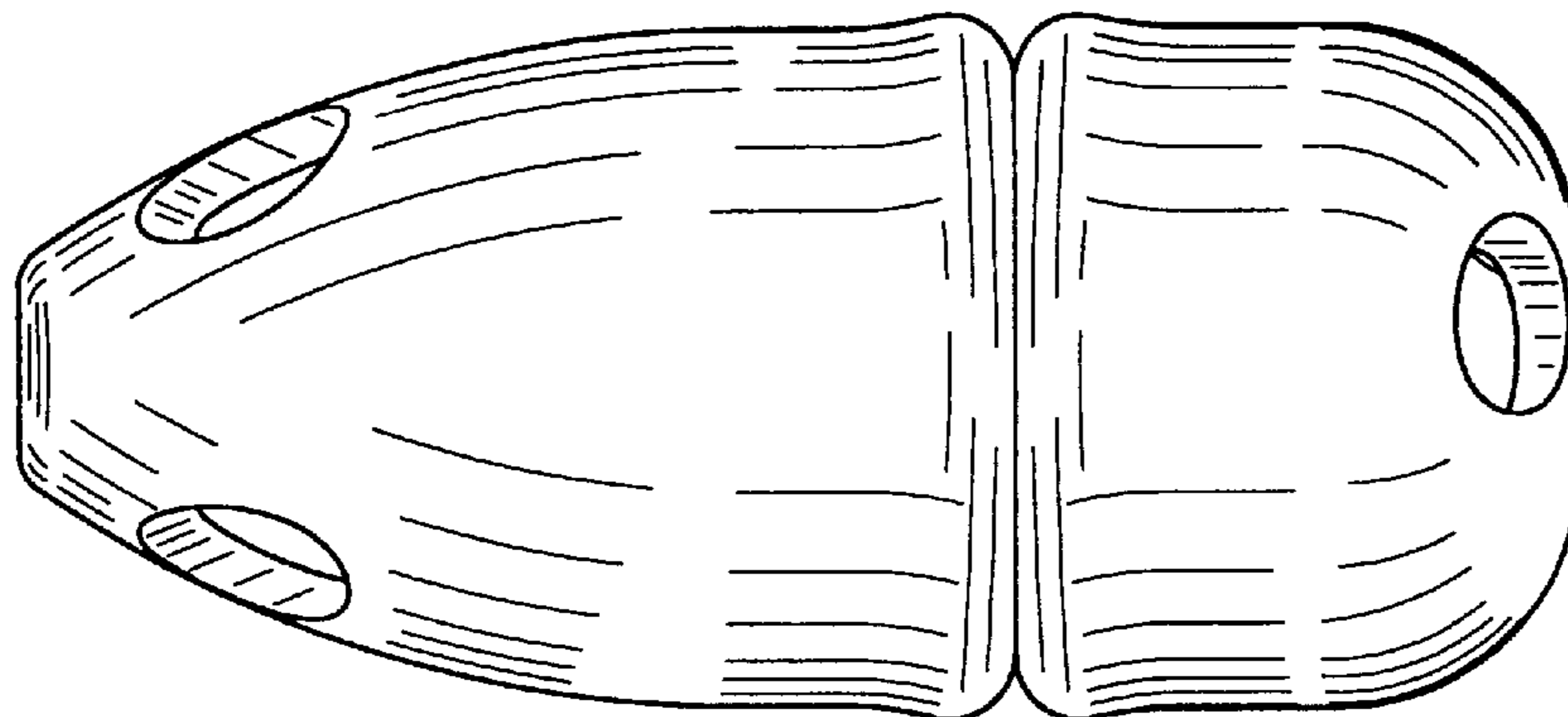

FIG. 4

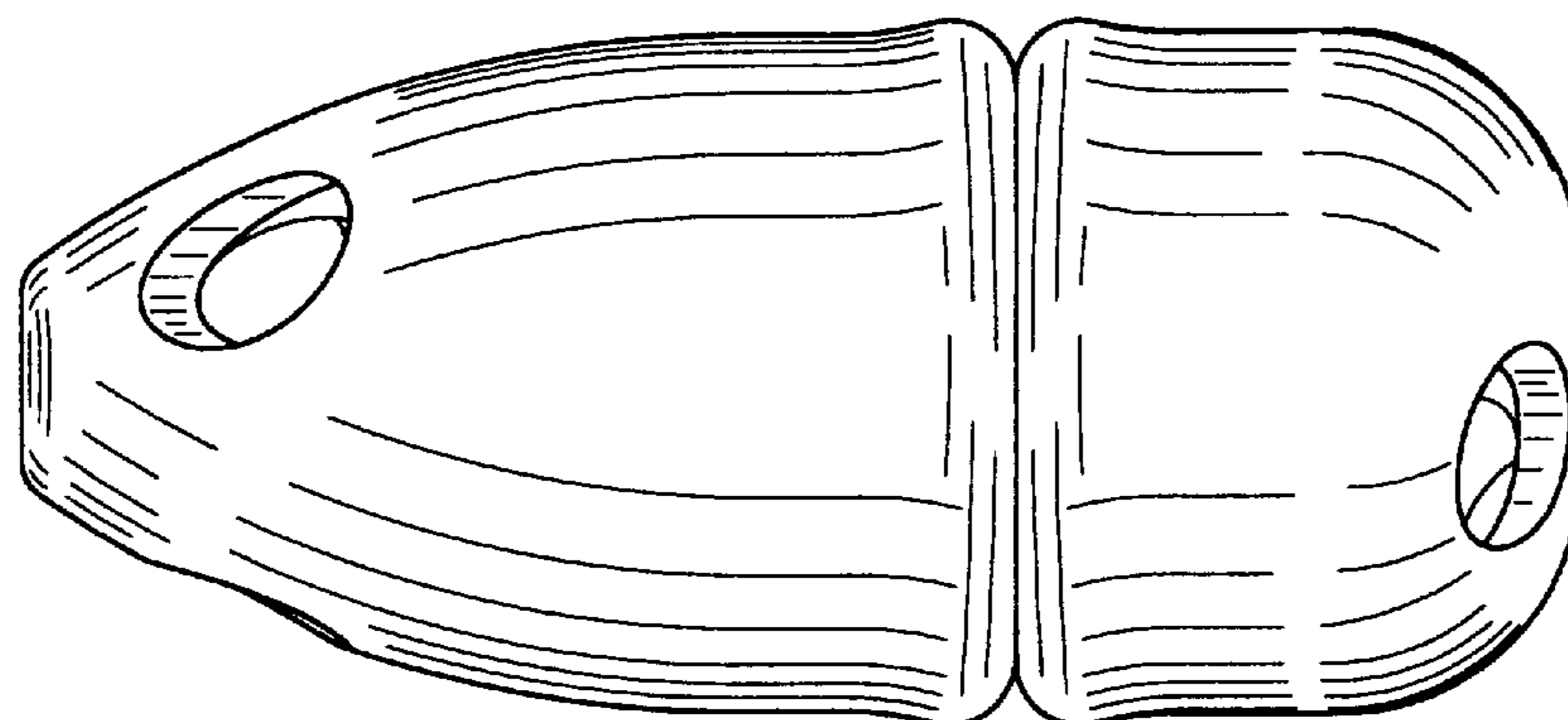

FIG. 5

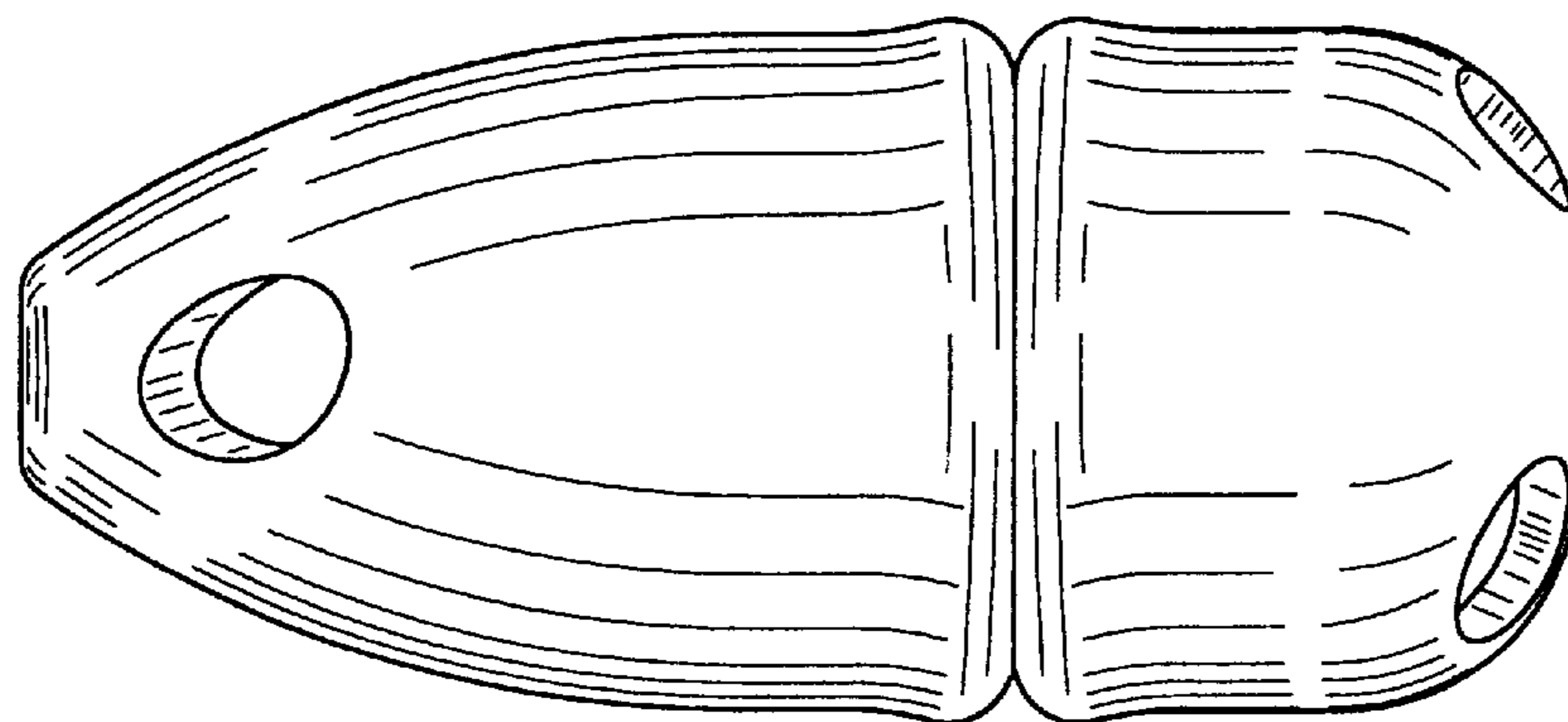

FIG. 6

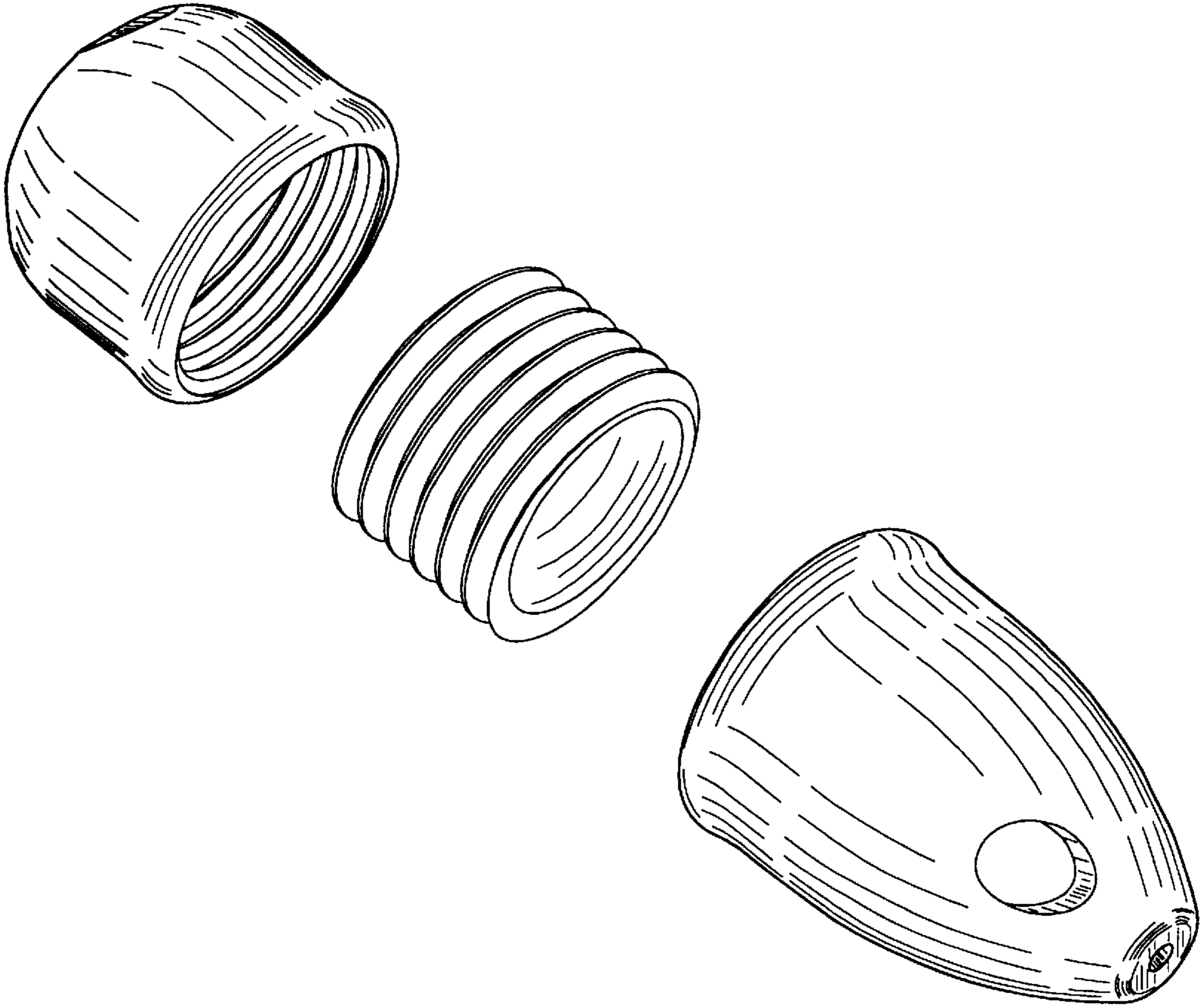

FIG. 7

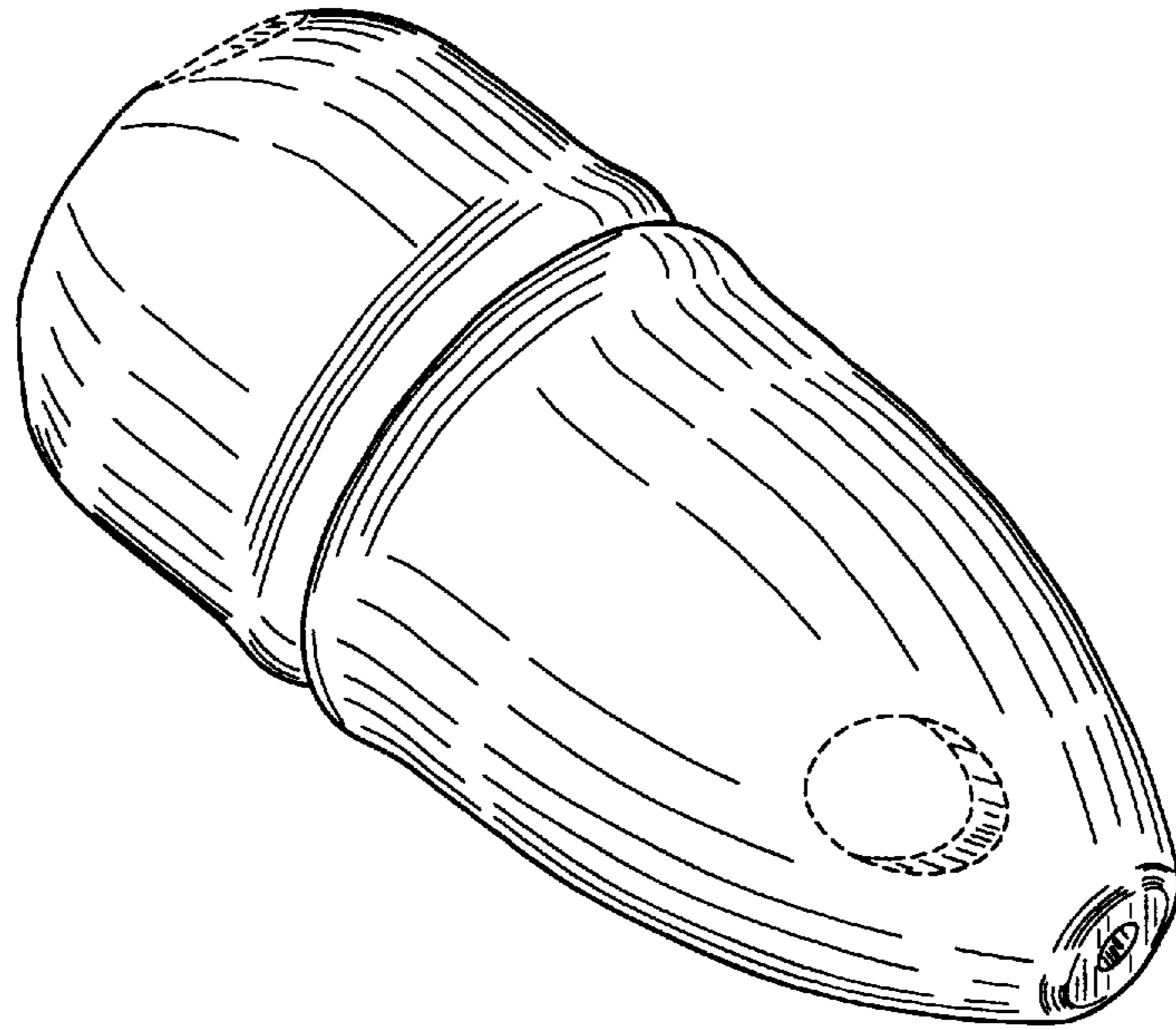

FIG. 8

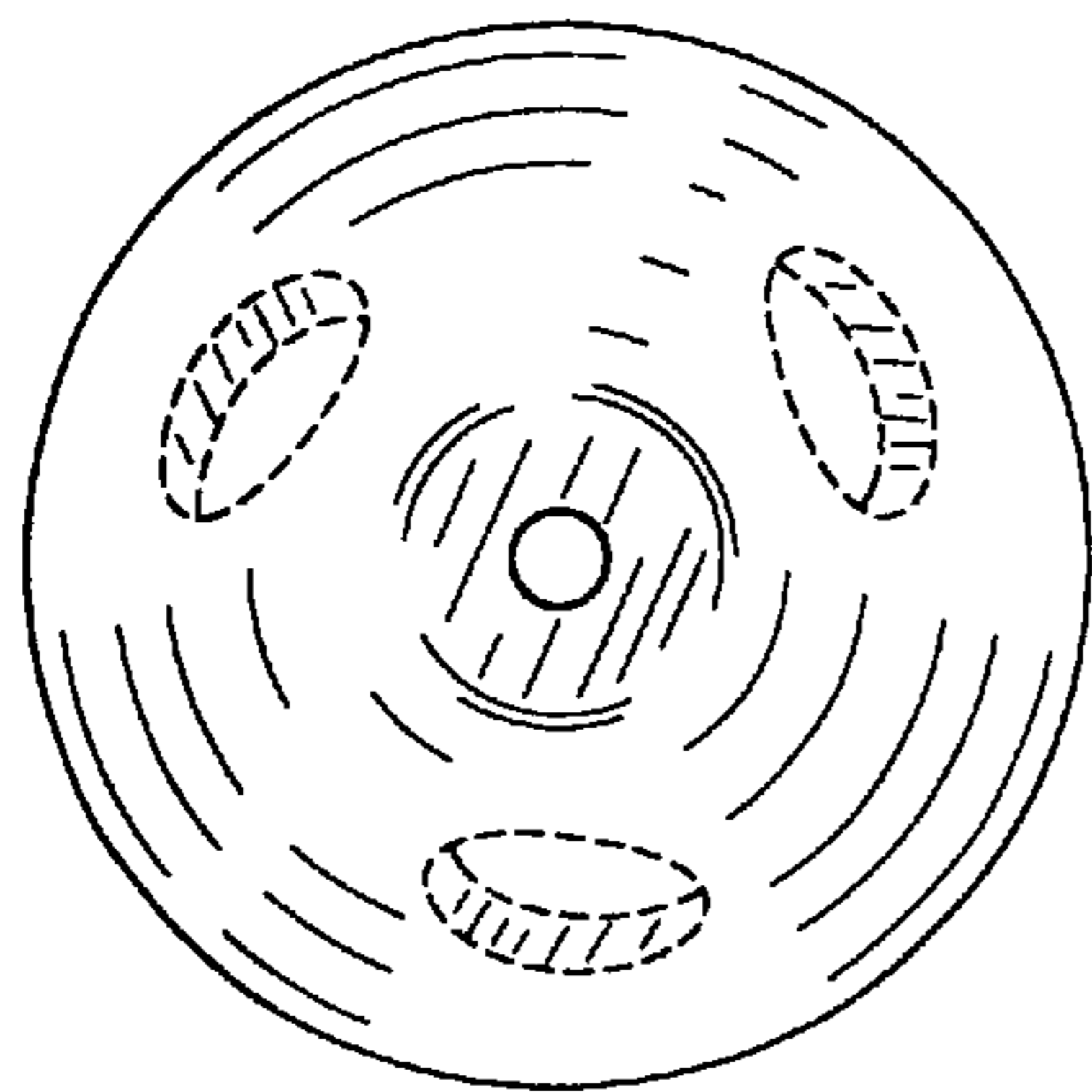

FIG. 9

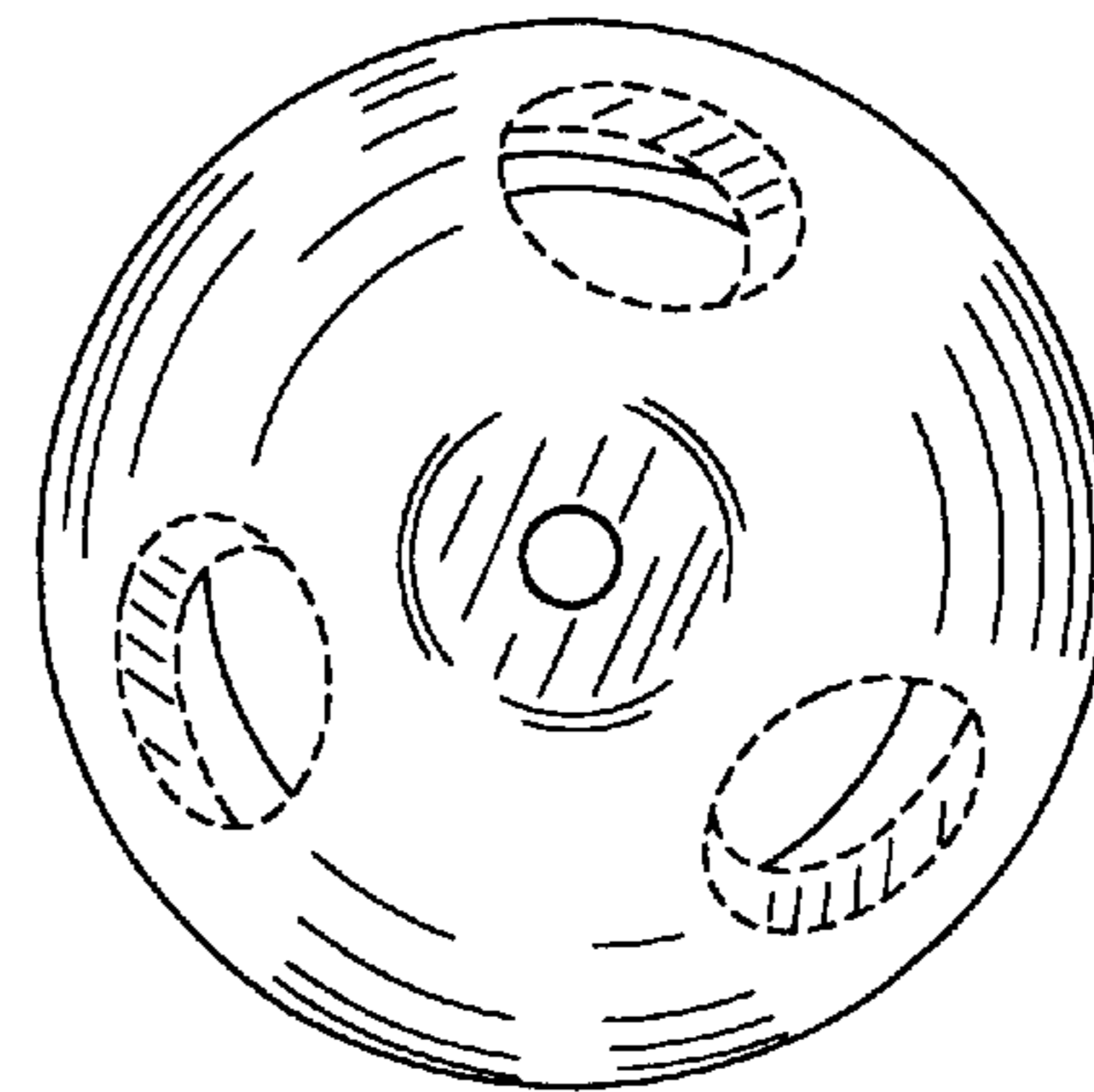

FIG. 10

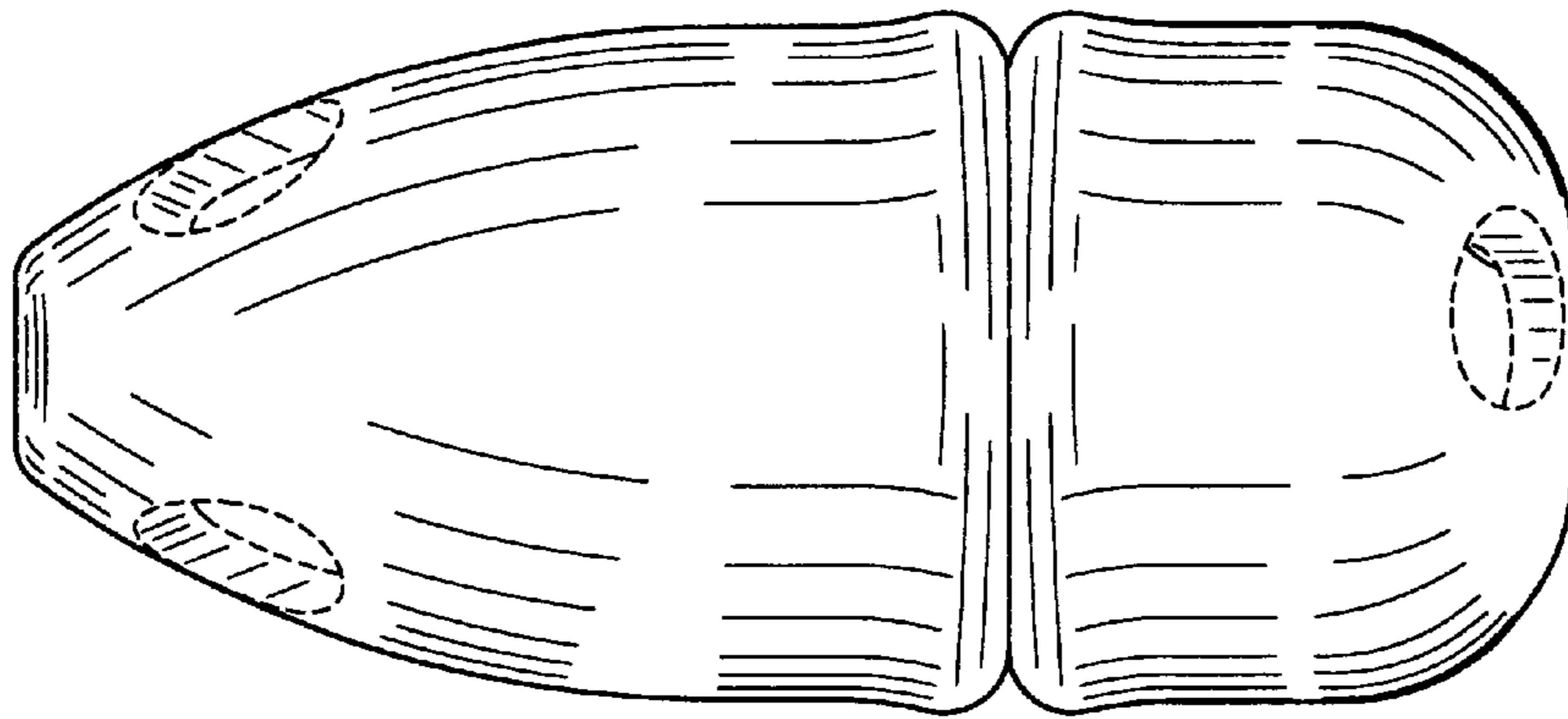

FIG. 11

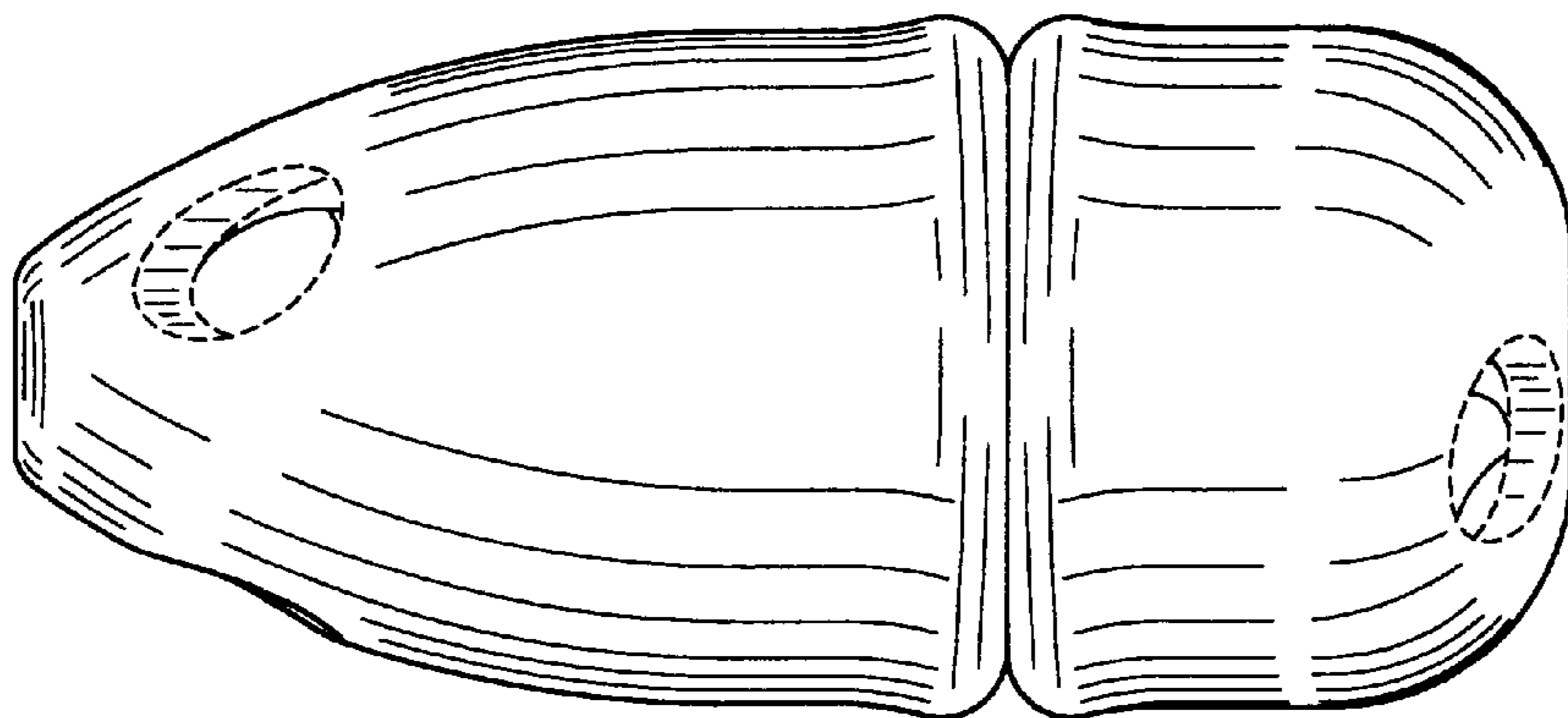

FIG. 12

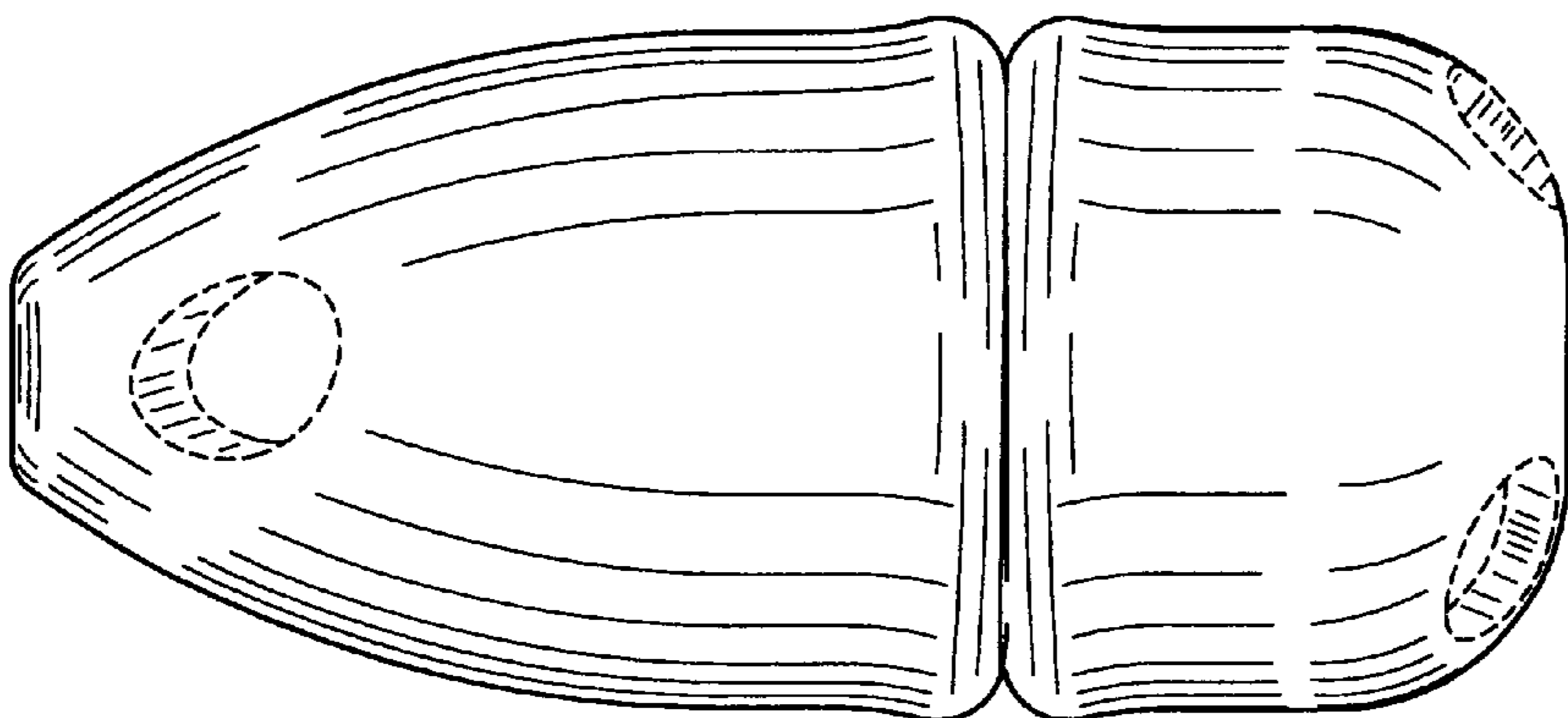

FIG. 13

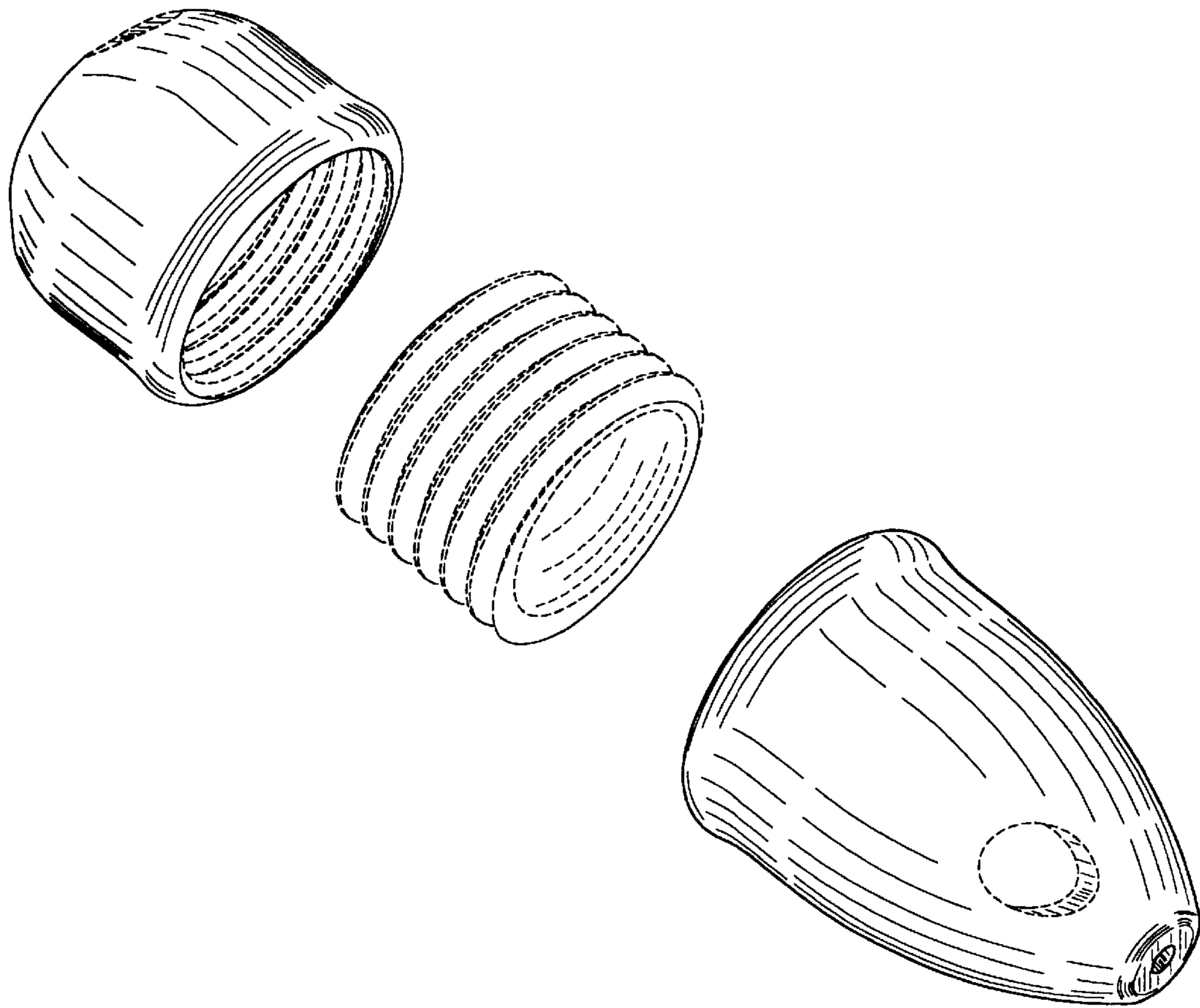

FIG. 14



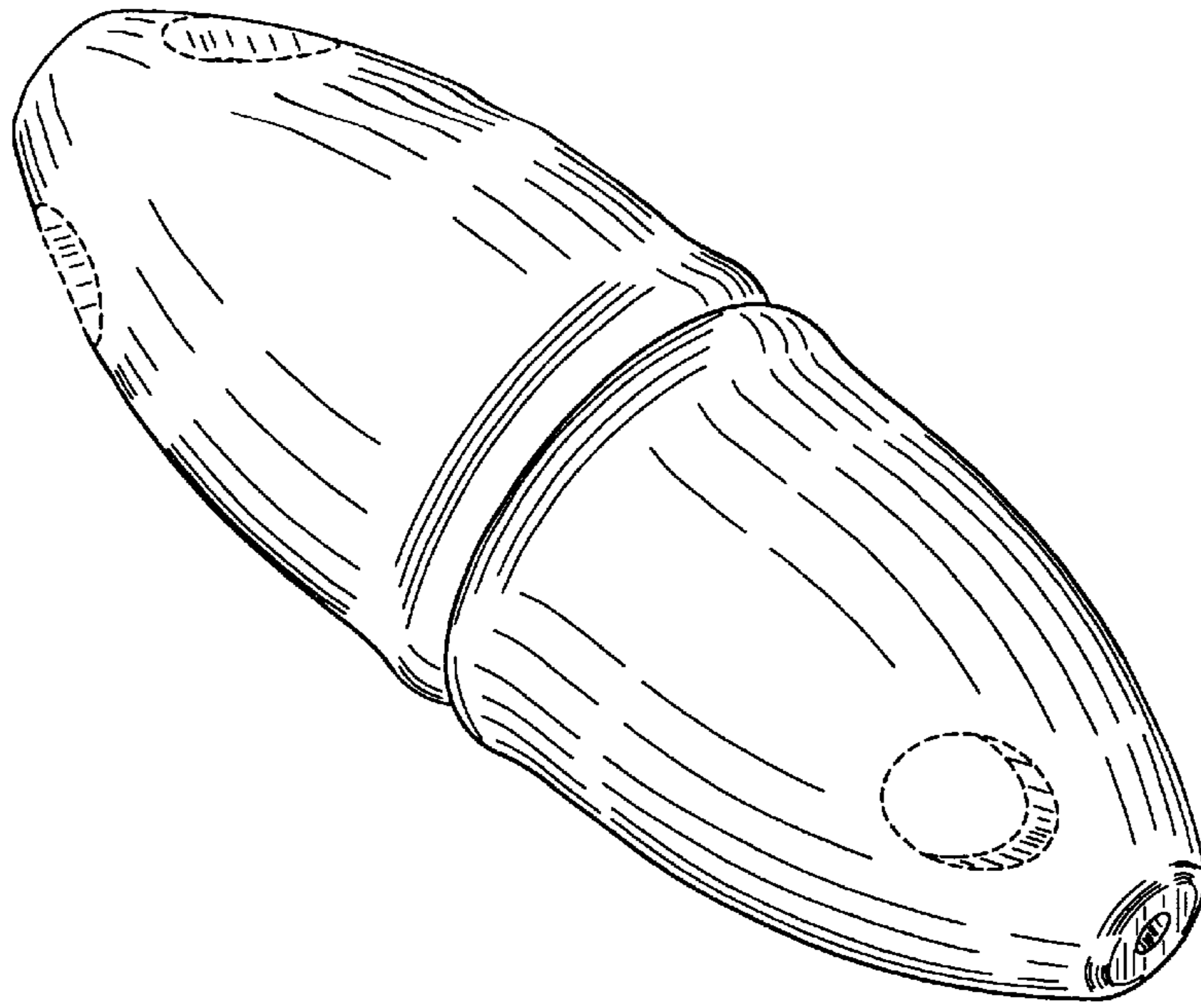

FIG. 15

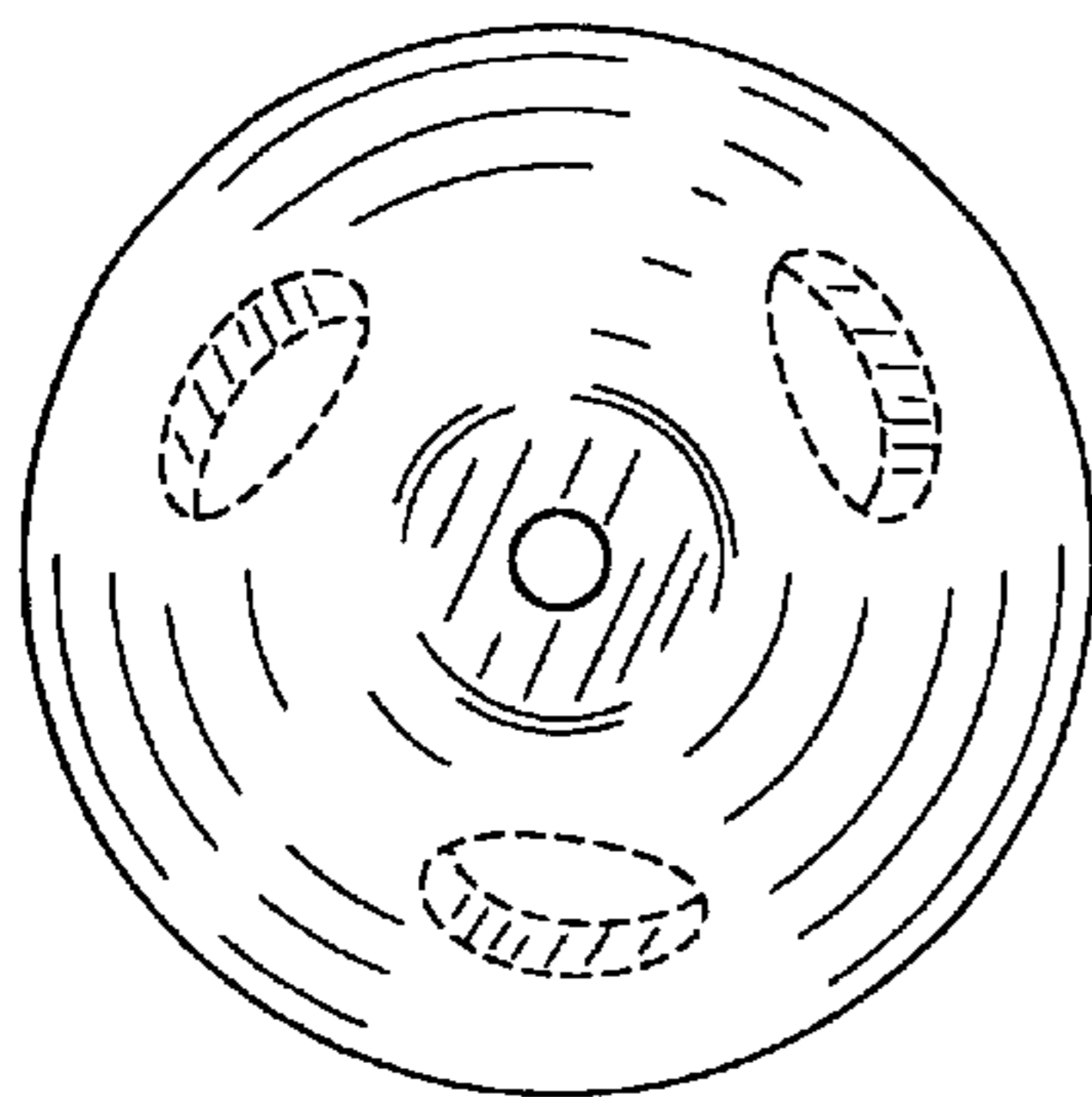

FIG. 16

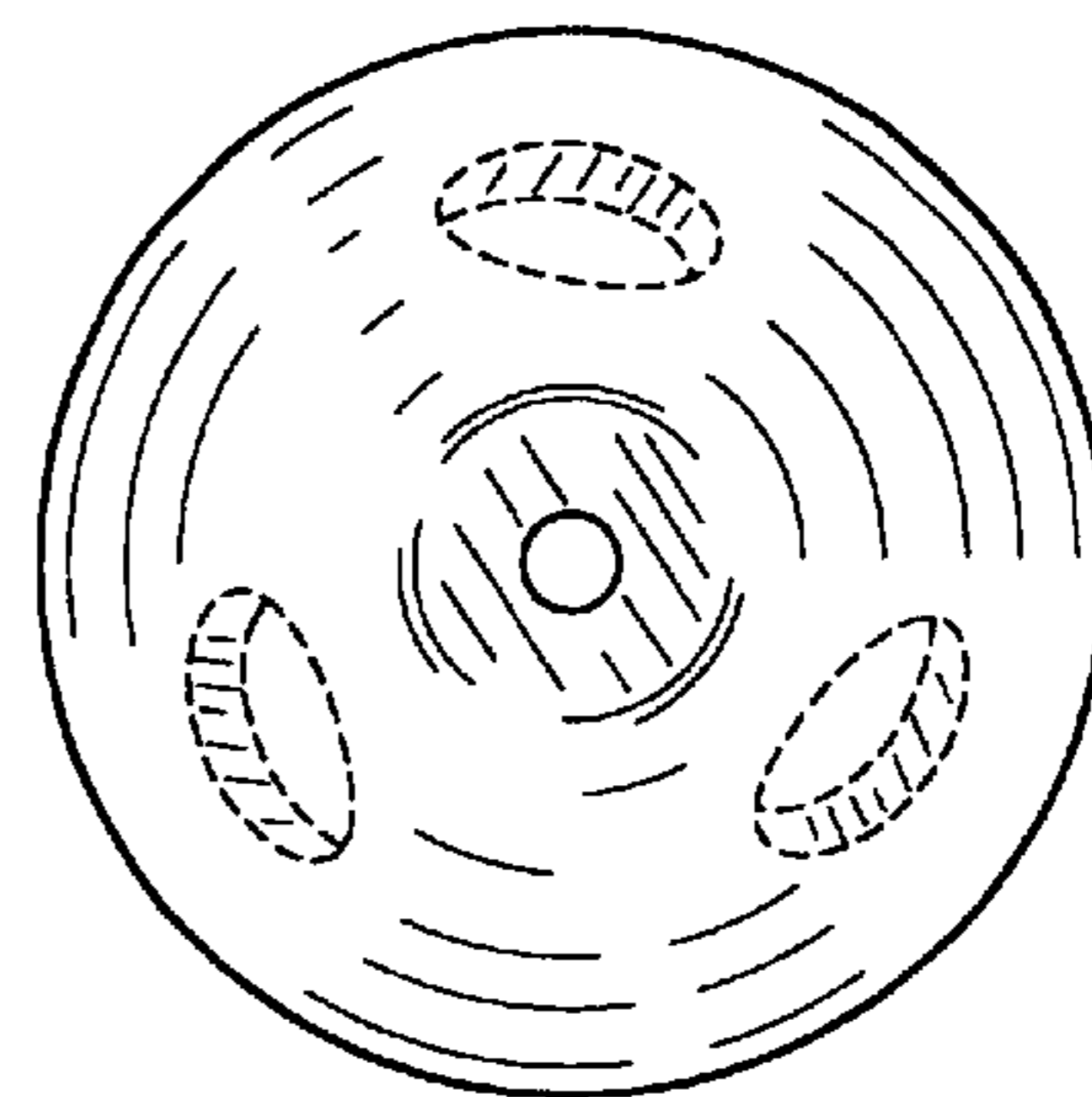

FIG. 17

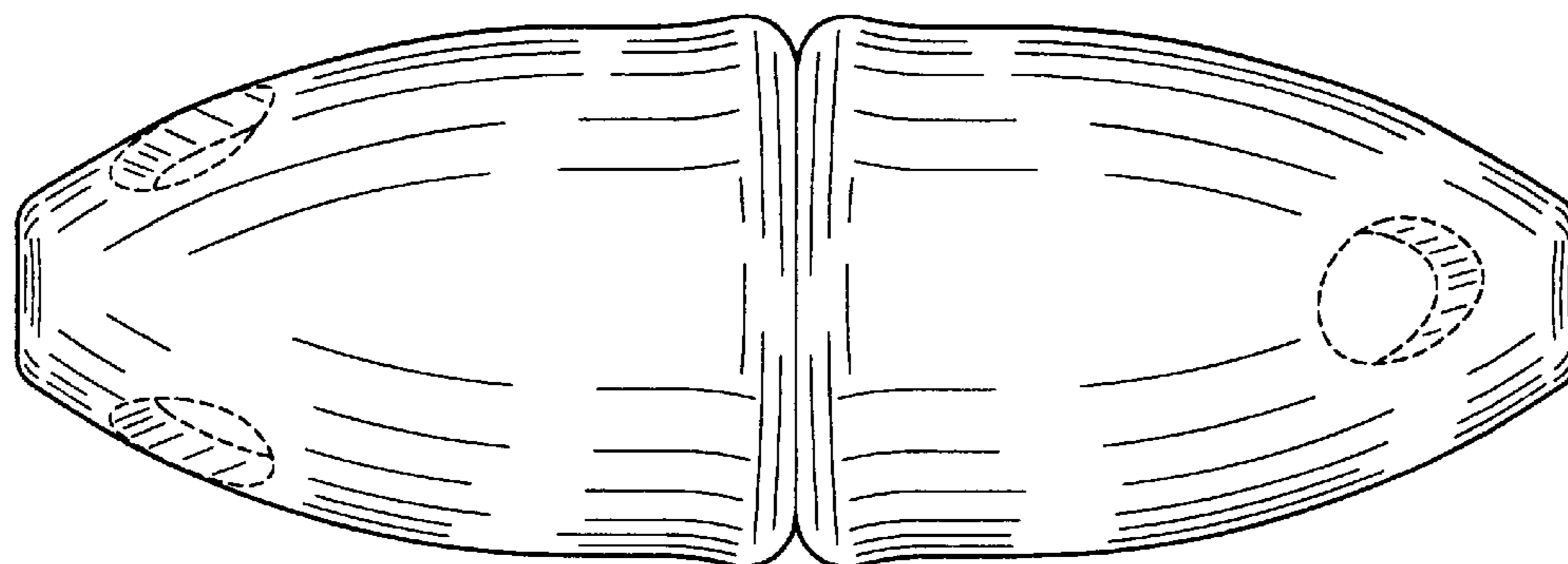

FIG. 18

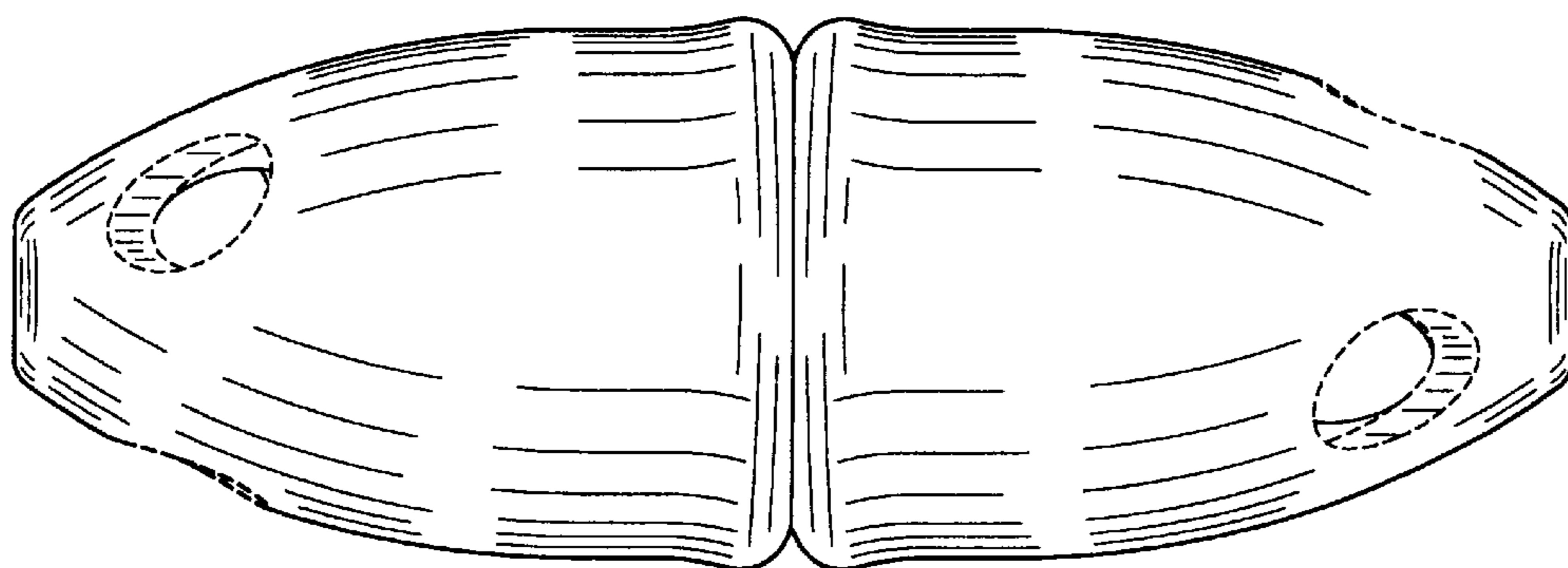

FIG. 19

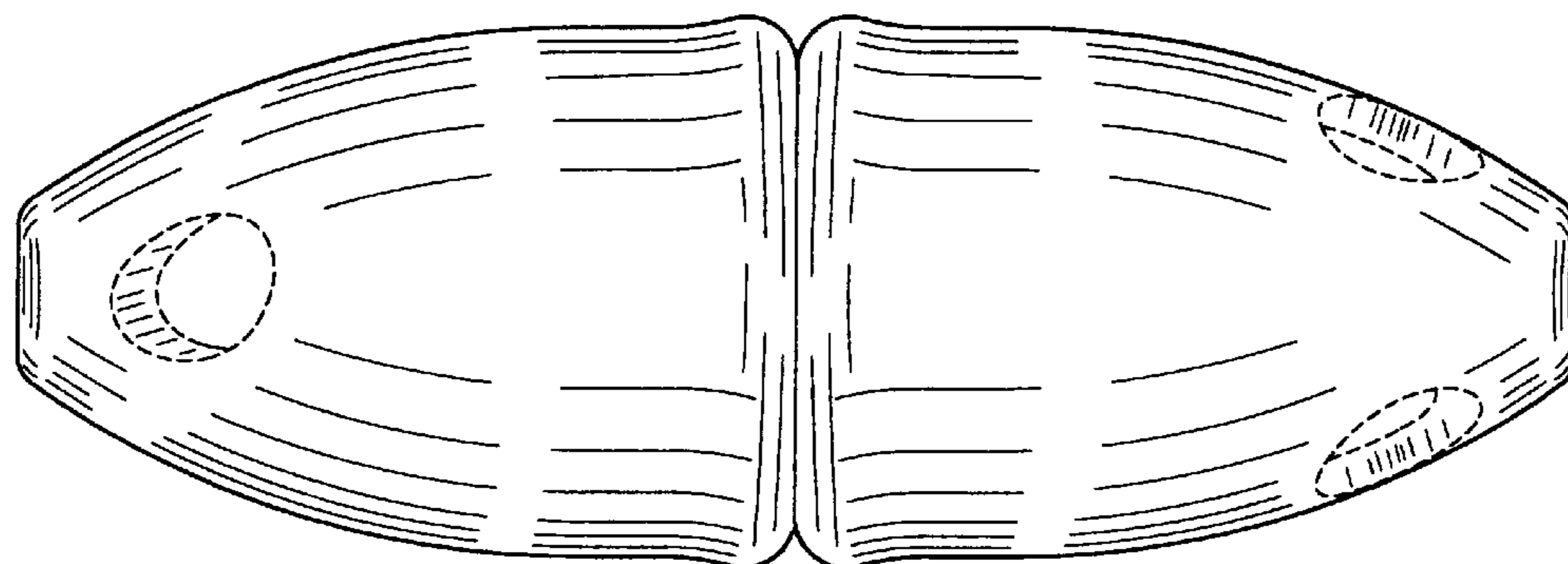

FIG. 20

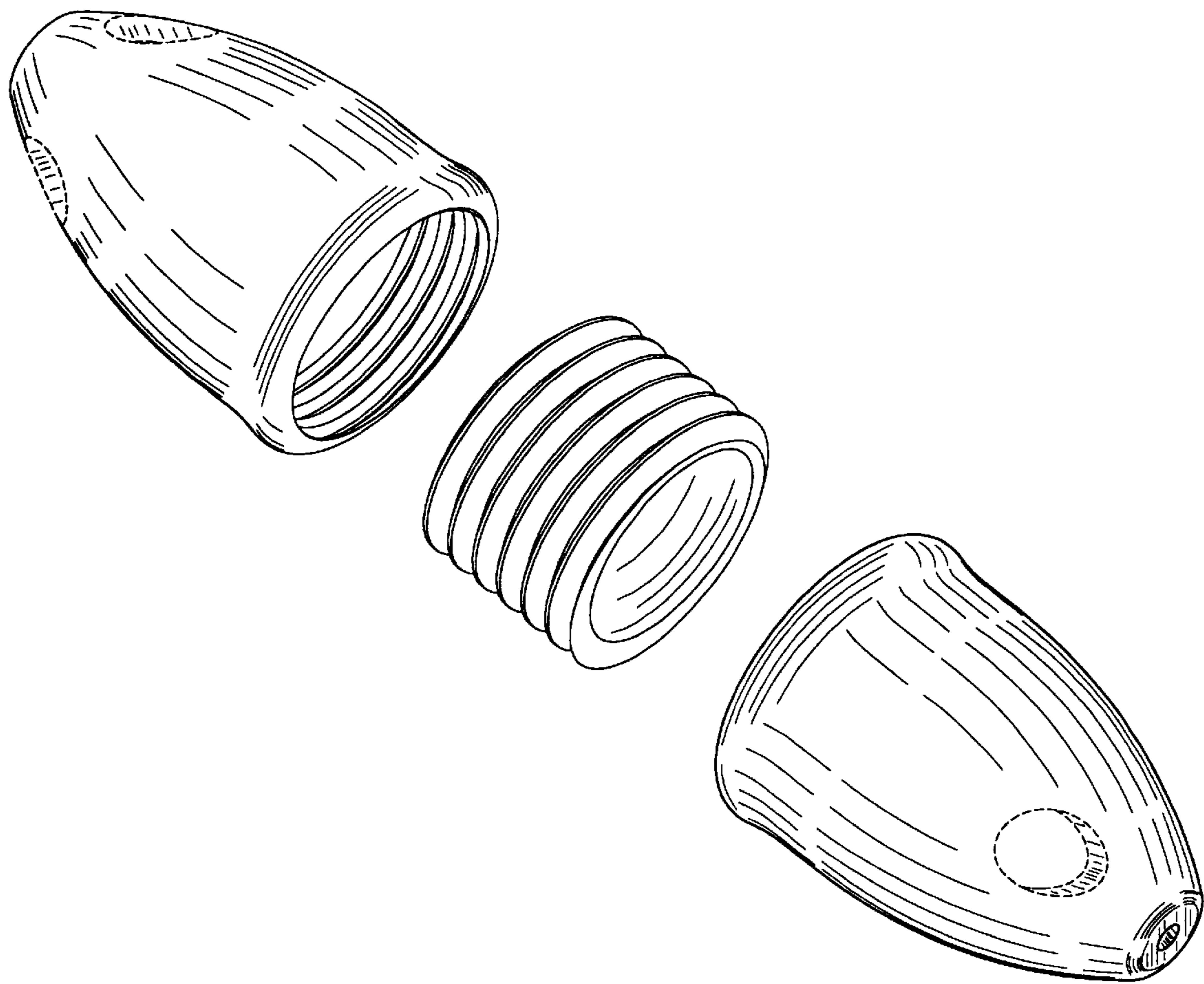

FIG. 21

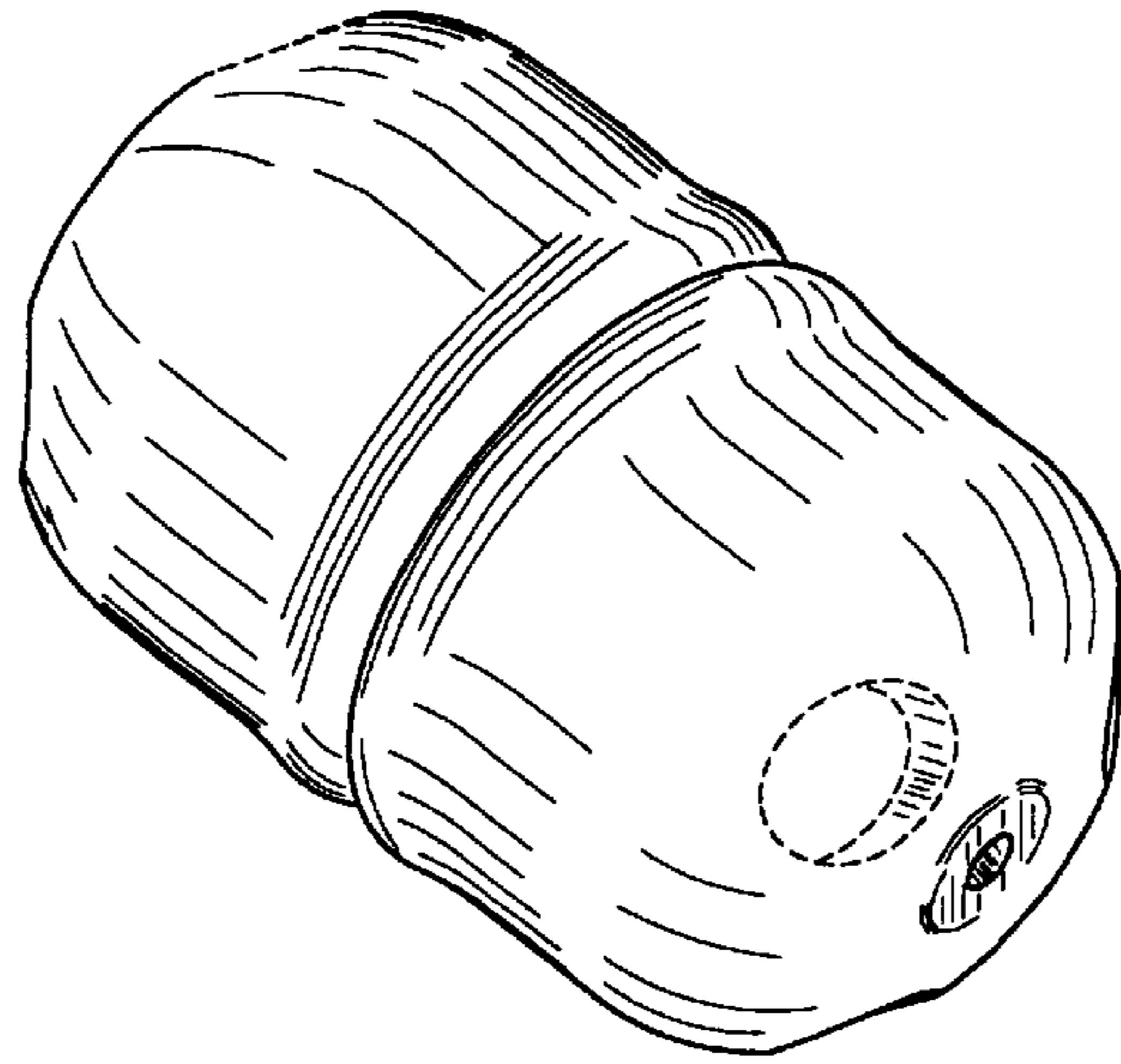

FIG. 22

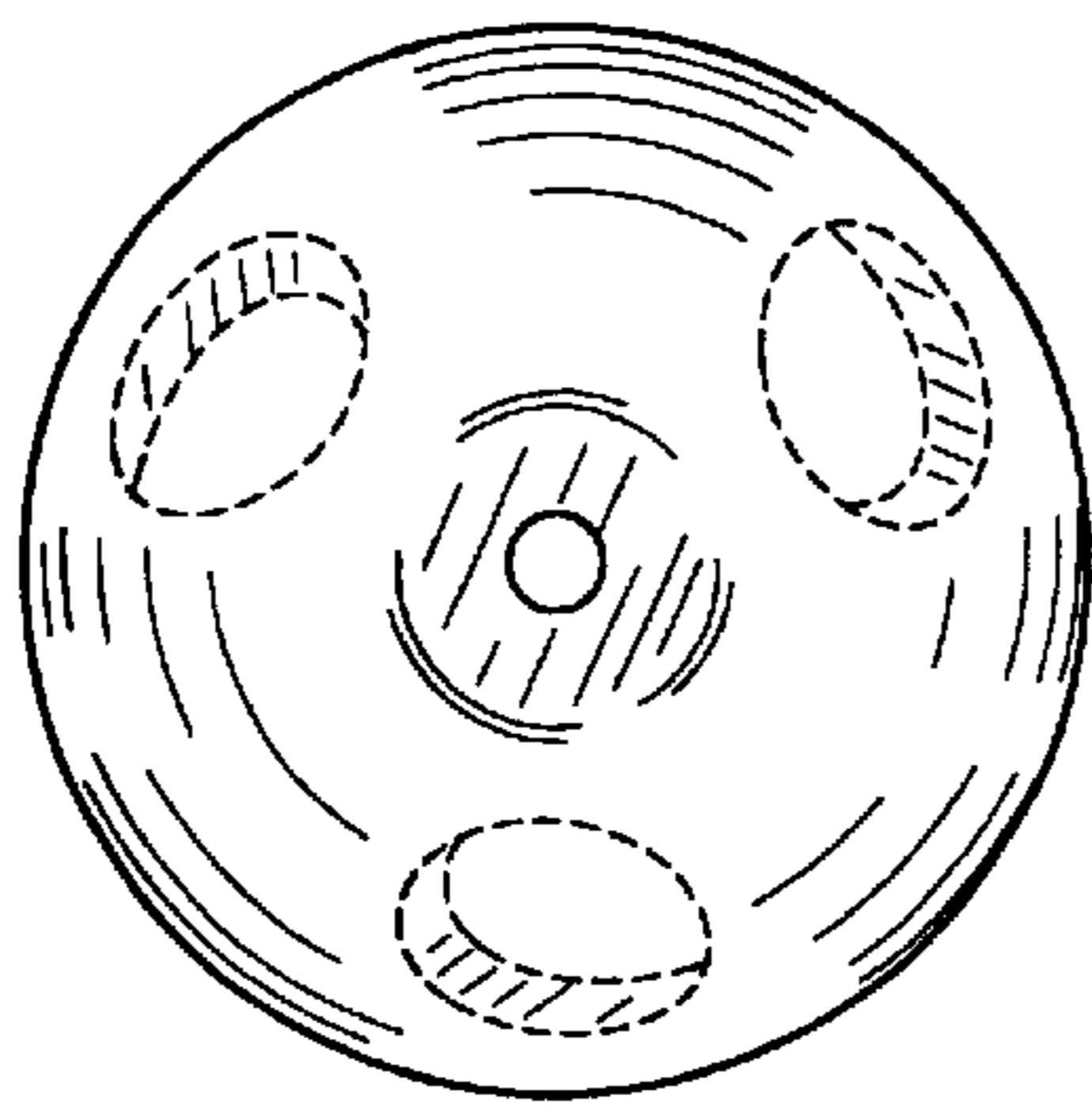

FIG. 23

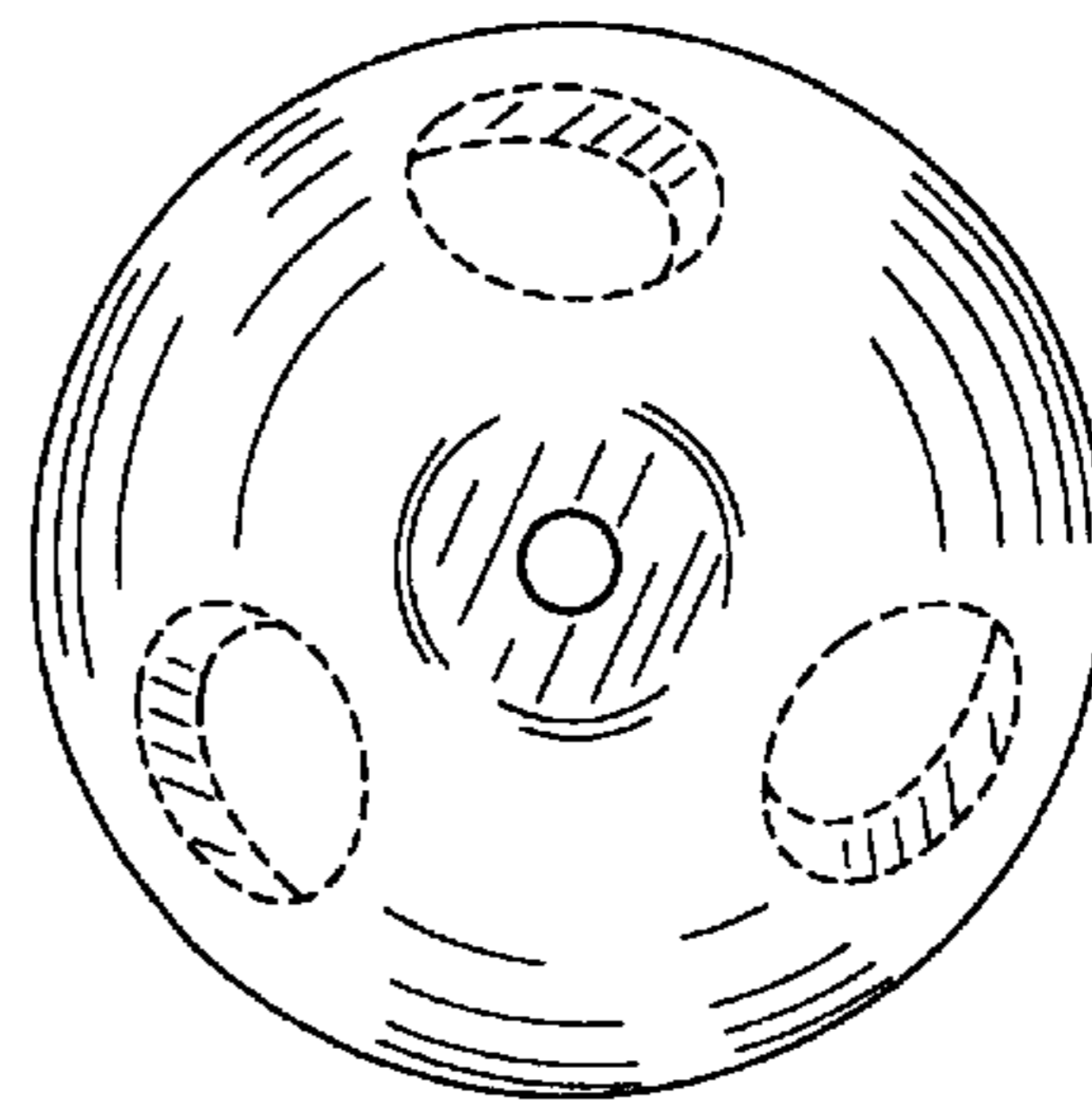

FIG. 24

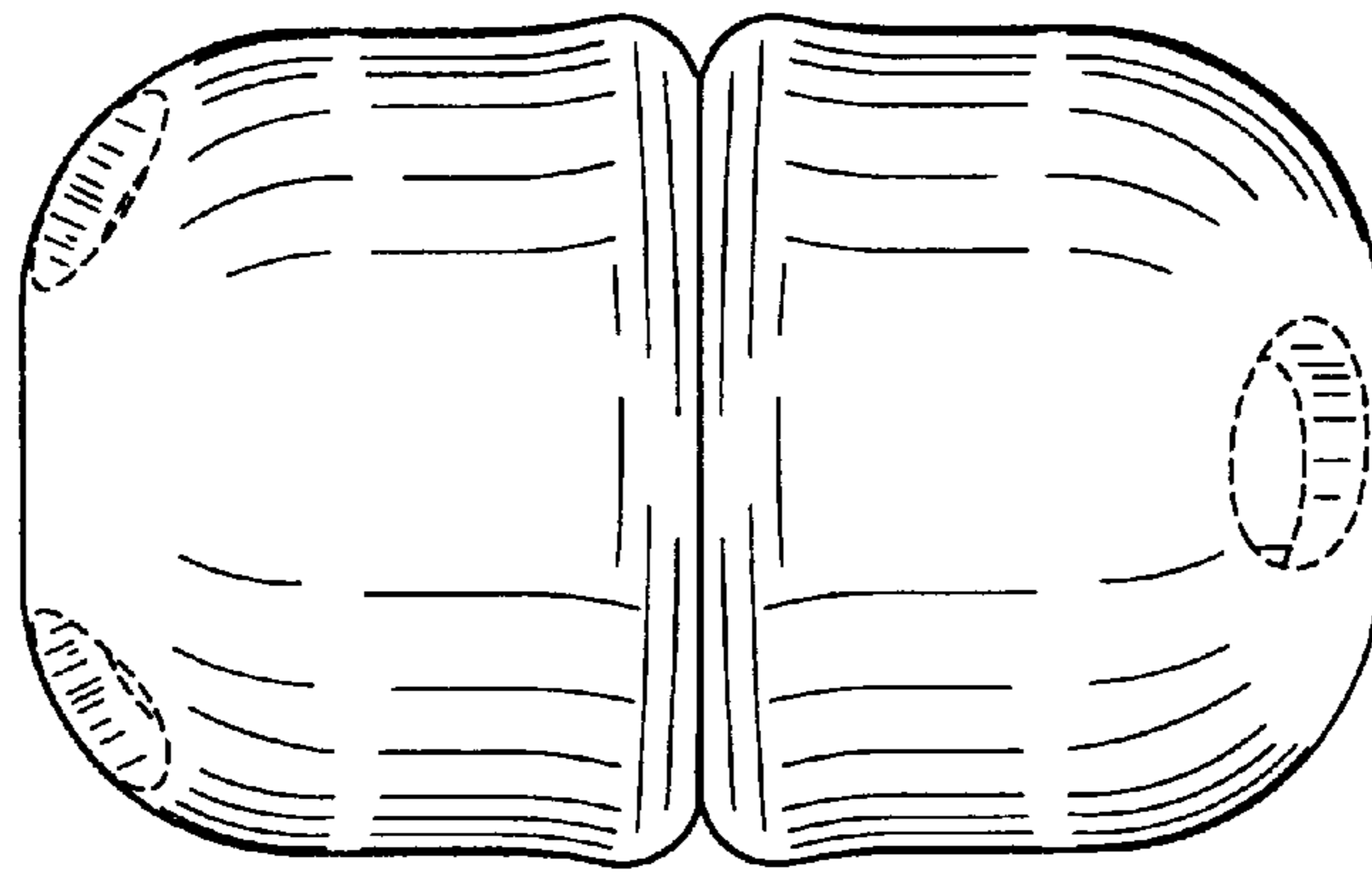

FIG. 25

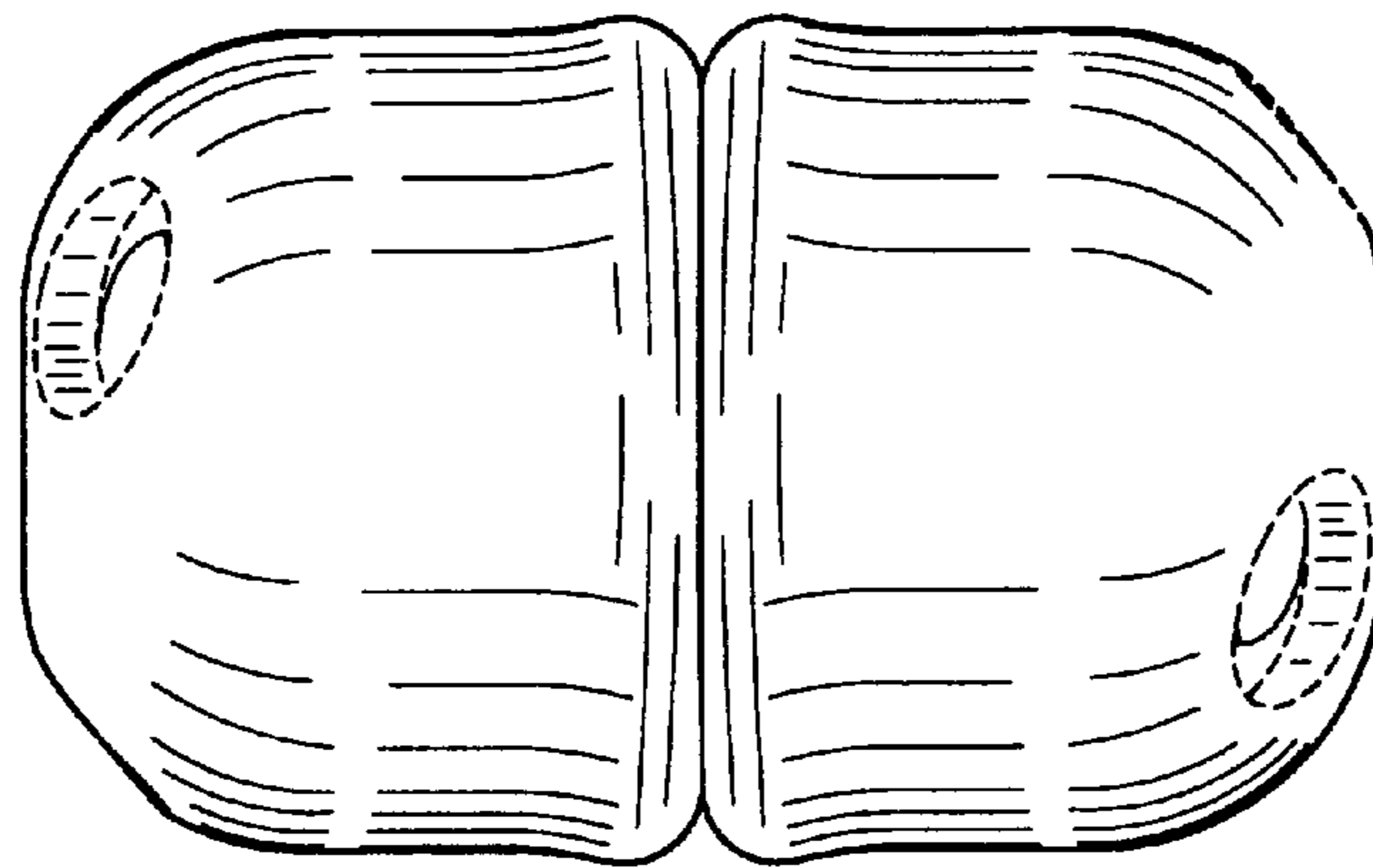

FIG. 26

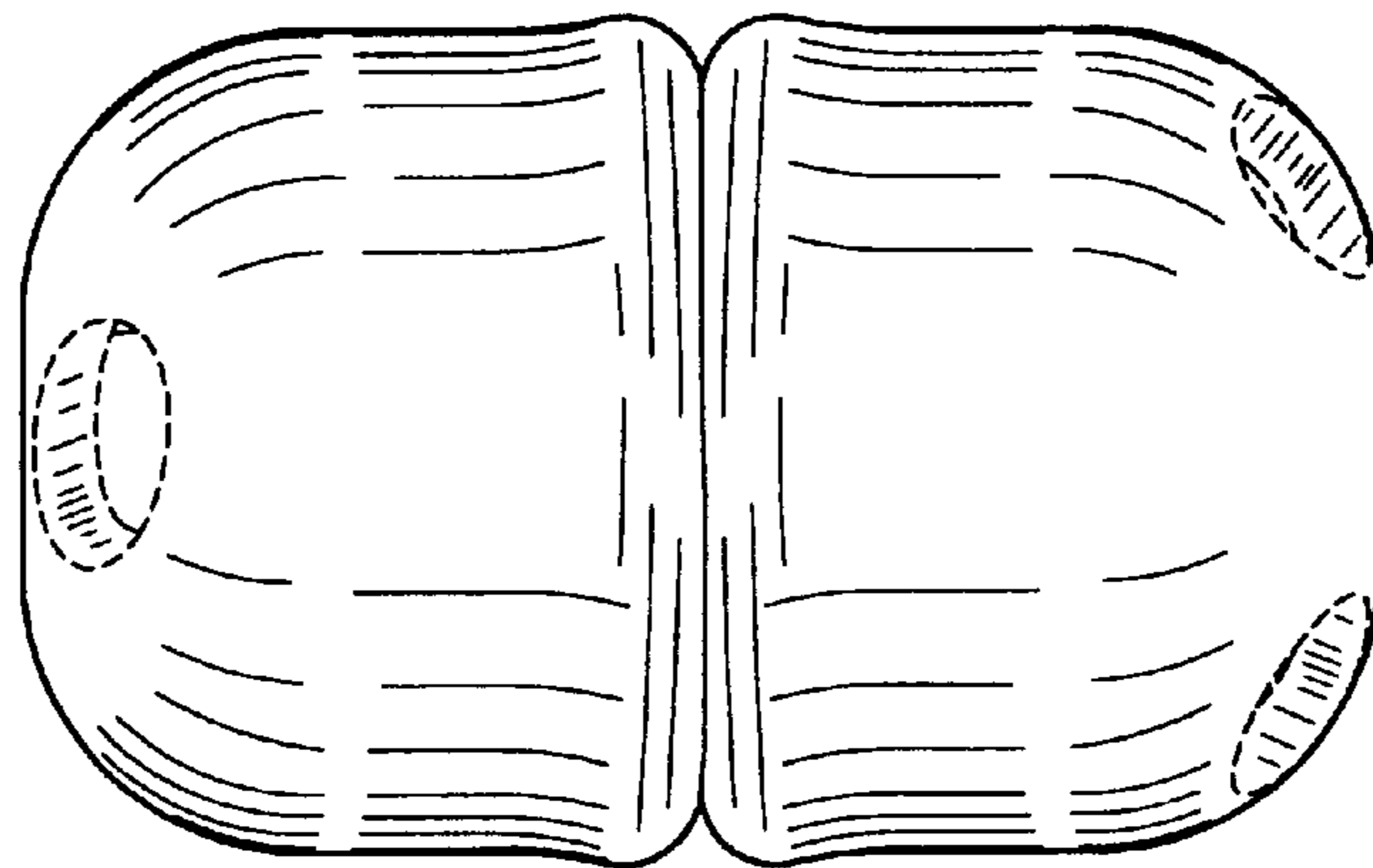

FIG. 27

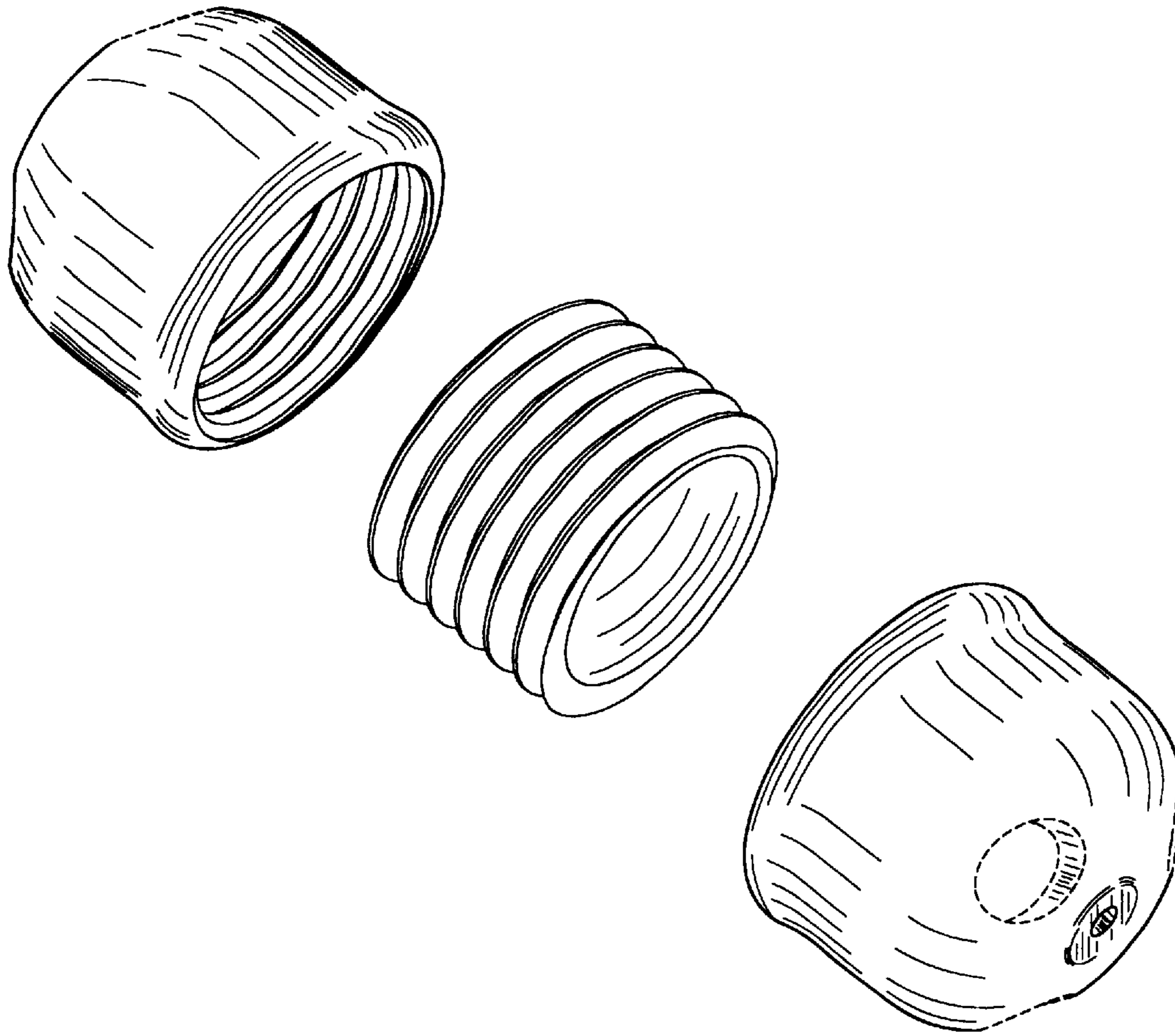

FIG. 28