



US00D525314S

(12) **United States Design Patent** (10) **Patent No.:** **US D525,314 S**
Elkhoury (45) **Date of Patent:** **** Jul. 18, 2006**

(54) **BOARD GAME**

(76) Inventor: **Samir Elkhoury**, 635 Quail Ridge Cir.,
Mendota Heights, MN (US) 55118

(**) Term: **14 Years**

(21) Appl. No.: **29/217,309**

(22) Filed: **Nov. 15, 2004**

(51) **LOC (8) Cl.** **21-01**

(52) **U.S. Cl.** **D21/337; D21/338; D21/341**

(58) **Field of Classification Search** **D21/334-368;**
273/236-288

See application file for complete search history.

(56) **References Cited**

U.S. PATENT DOCUMENTS

4,111,429	A	*	9/1978	Waski	273/271
D261,283	S	*	10/1981	Becker et al.	D21/363
D308,655	S	*	6/1990	Hardy	D21/363
5,004,245	A	*	4/1991	Schumacher et al.	273/241
5,660,388	A	*	8/1997	Benn	273/241
D434,088	S	*	11/2000	Stuckman et al.	D21/342

* cited by examiner

Primary Examiner—Sandra L. Morris

(74) *Attorney, Agent, or Firm*—Skinner and Associates

(57) **CLAIM**

The ornamental design for a board game, as shown and described.

DESCRIPTION

FIG. 1 is a perspective view of a board game showing an embodiment of the design of this invention.

FIG. 2 is a top plan view thereof, with the game pieces shown removed for clarity of illustration.

FIG. 3 is a bottom view thereof.

FIG. 4 is a front view thereof, the back view being symmetrical.

FIG. 5 is a side view thereof, the opposite side being symmetrical.

FIG. 6 is a section view thereof.

FIG. 7 is an enlarged perspective view of a portion thereof, showing an alternative embodiment of the corner portion of the design, the remaining aspects of the alternative embodiment of the board game being identical to the embodiment shown in FIGS. 1-6; and,

FIG. 8 is a bottom perspective view thereof.

1 Claim, 6 Drawing Sheets

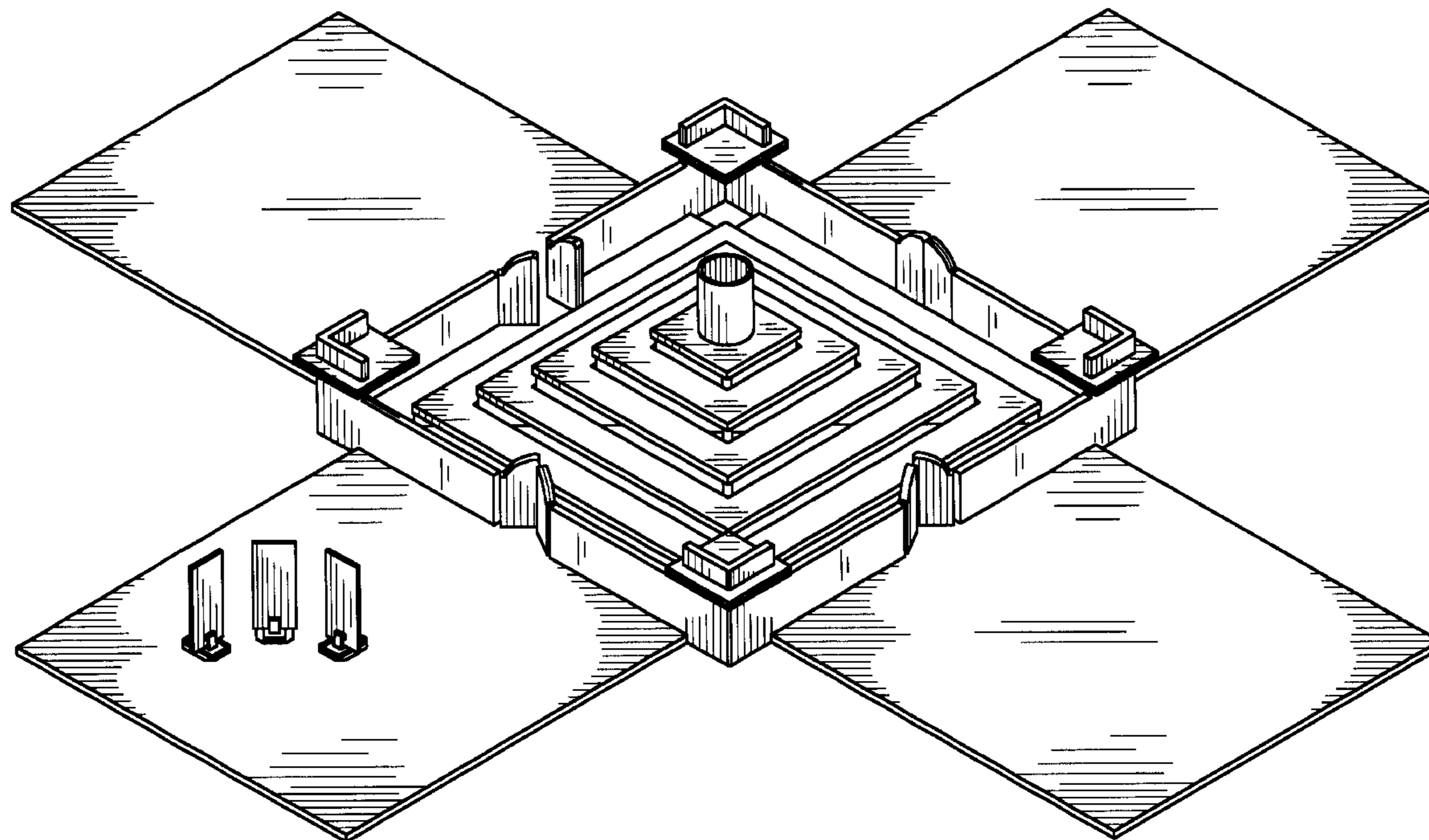

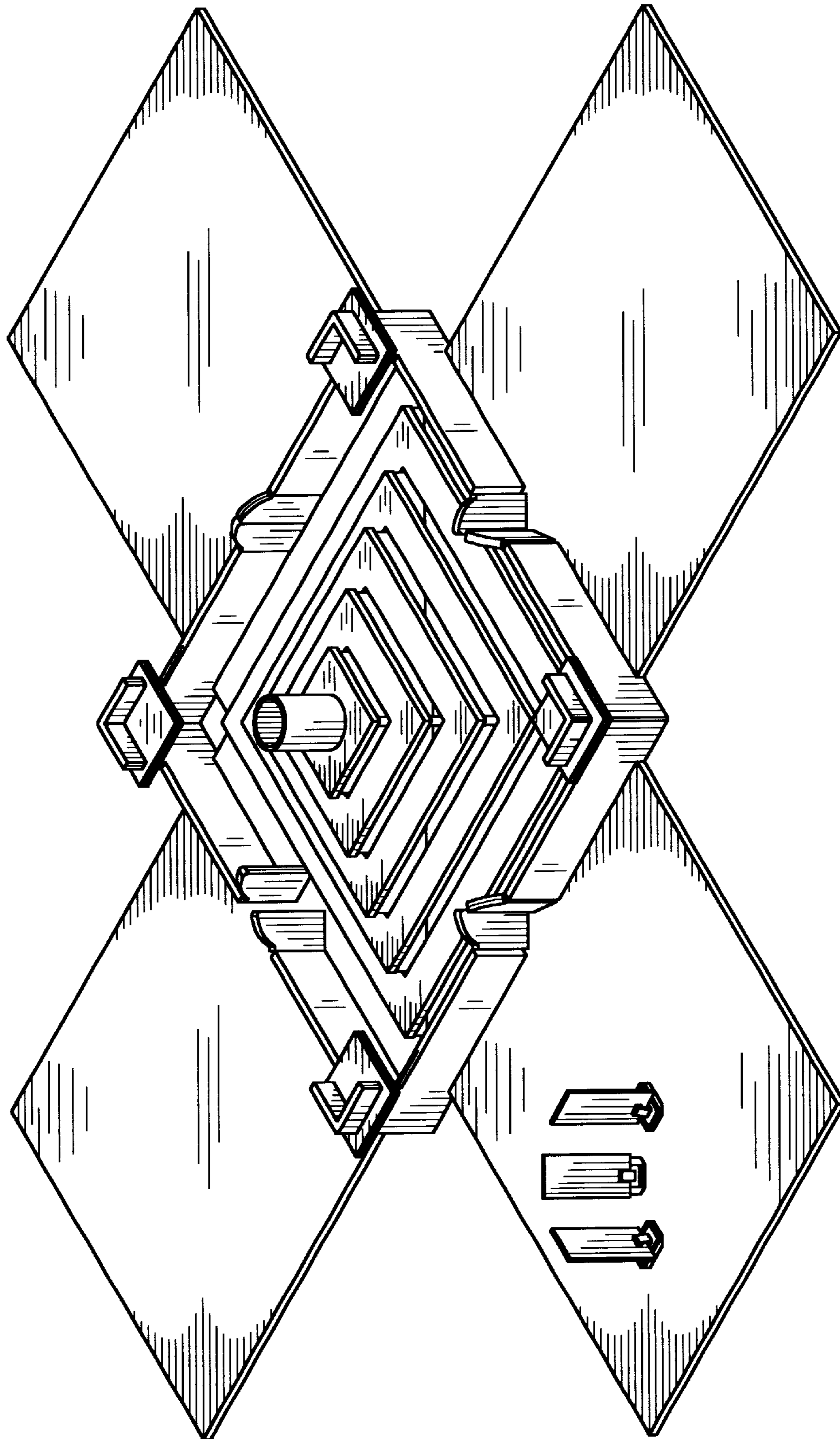

FIG. 1

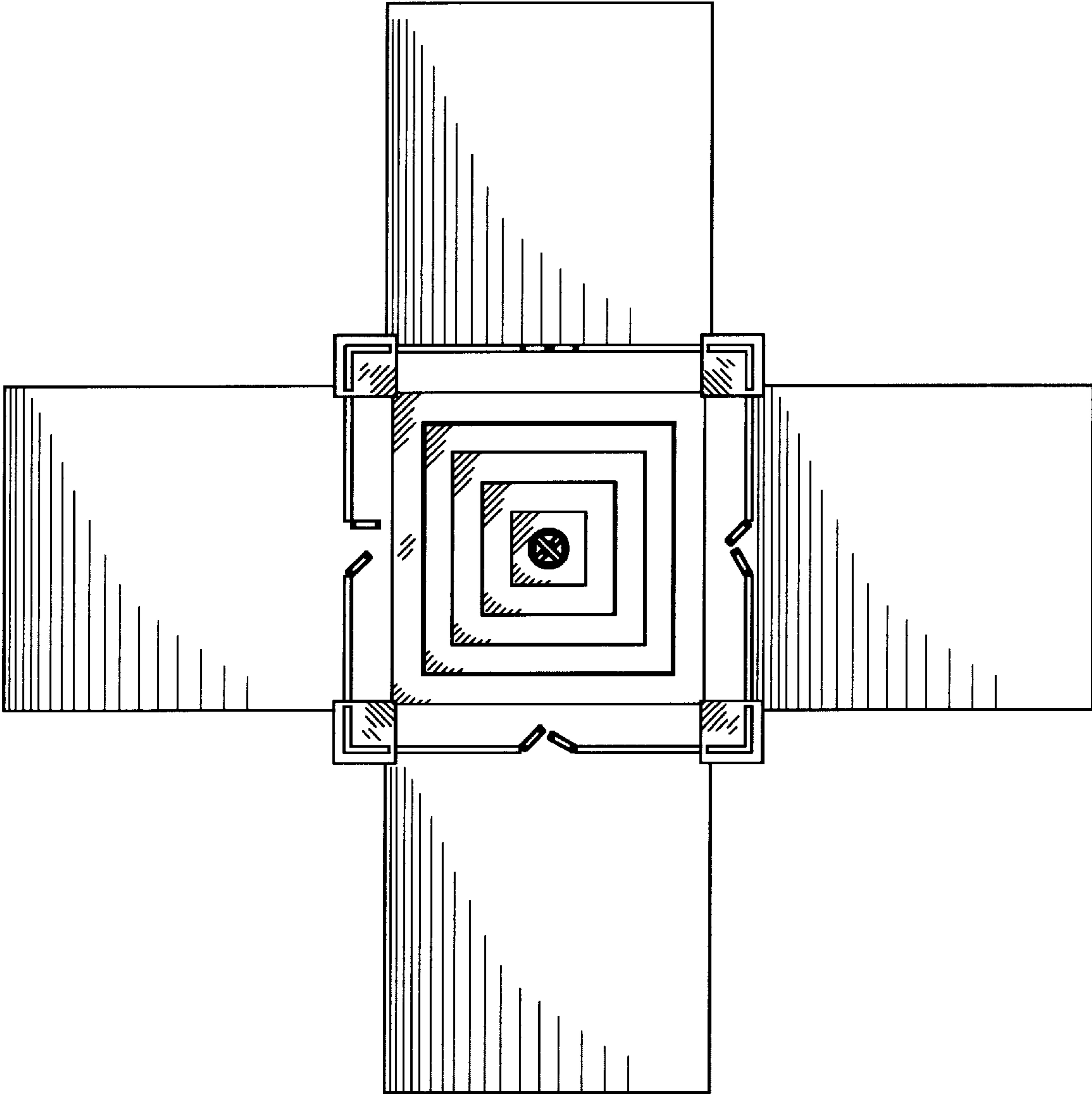

FIG. 2

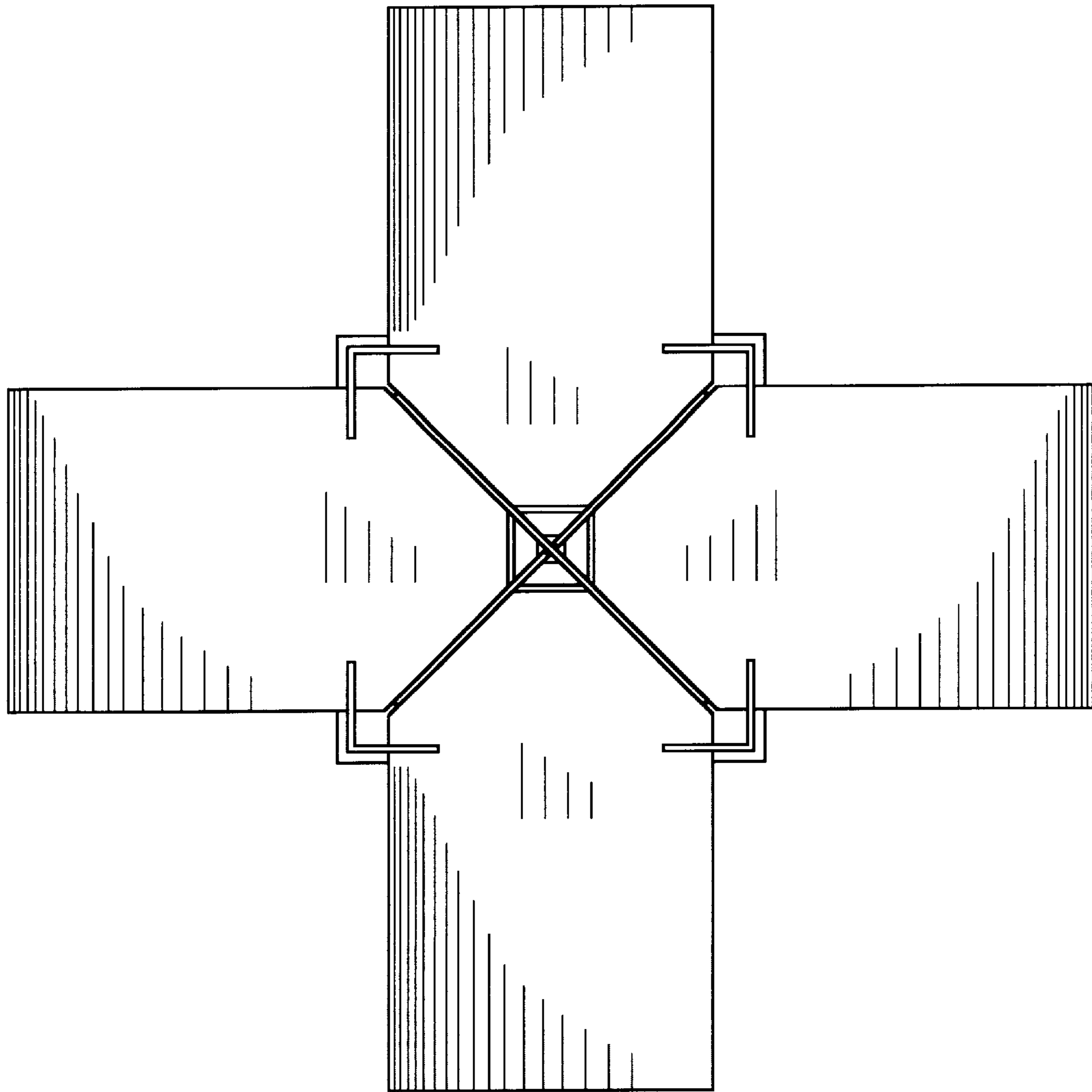

FIG. 3

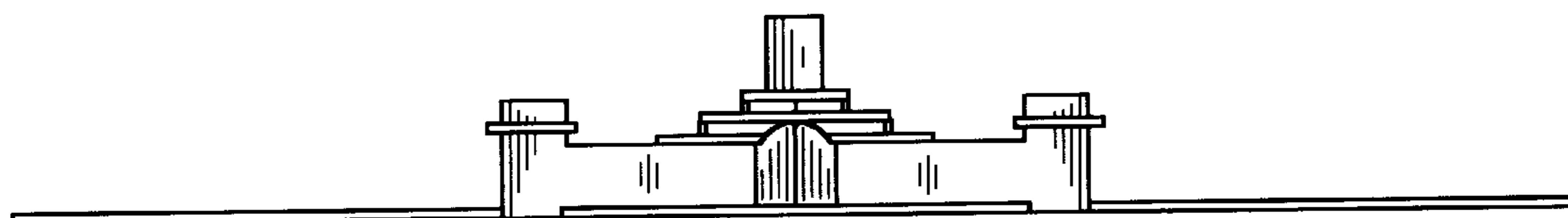

FIG. 4

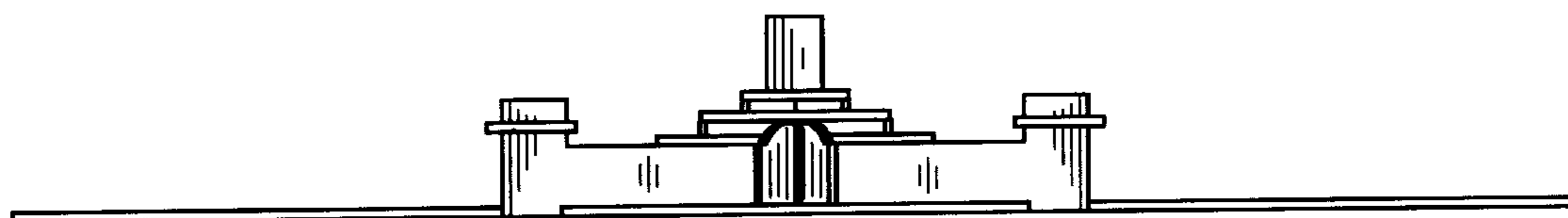

FIG. 5

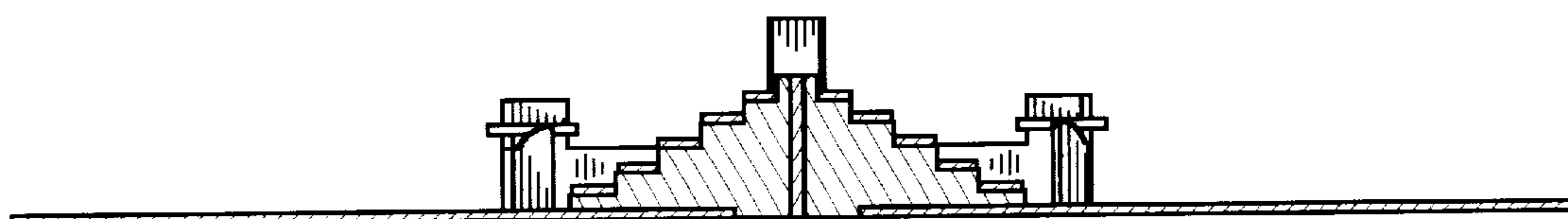

FIG. 6

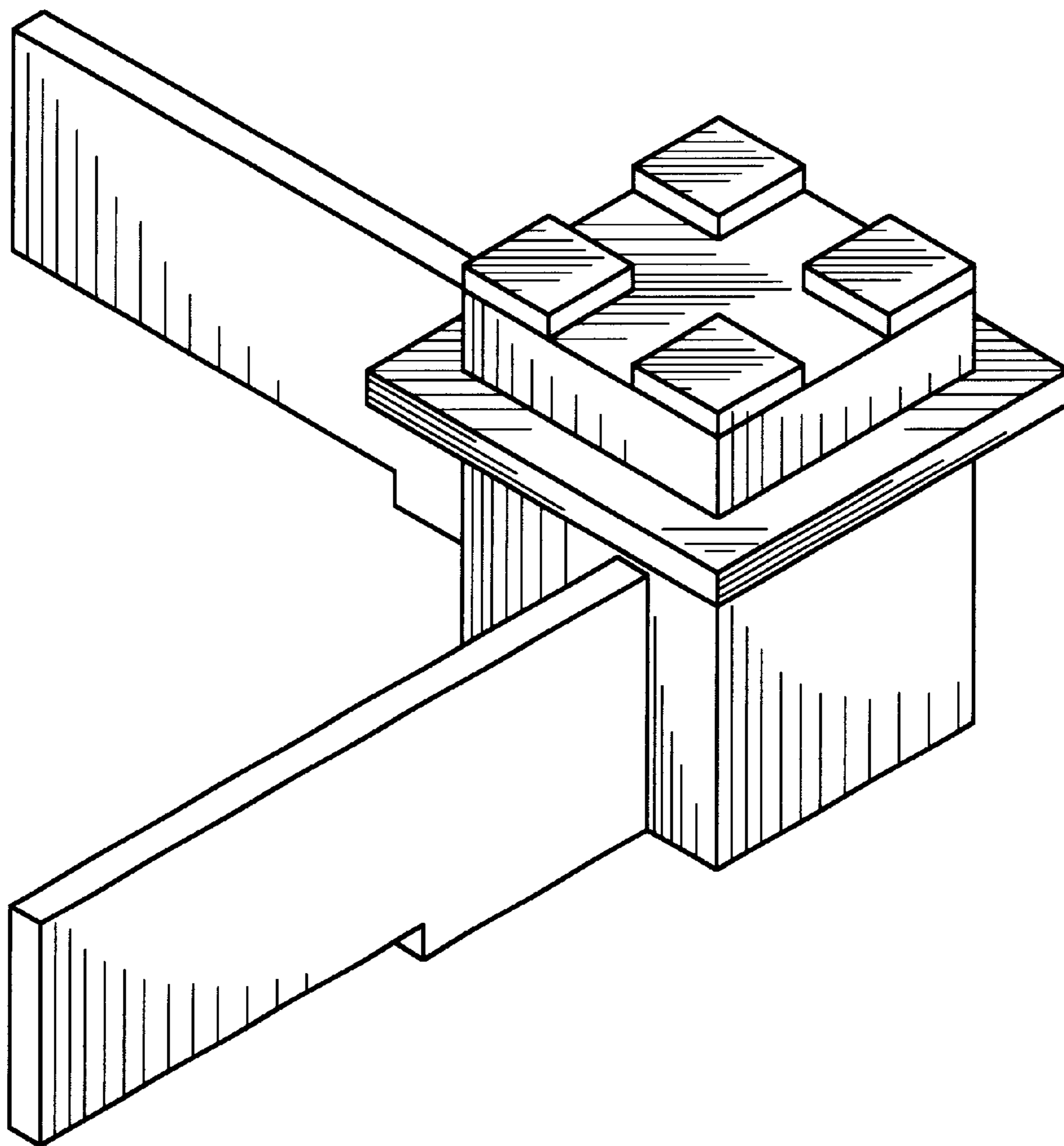

FIG. 7

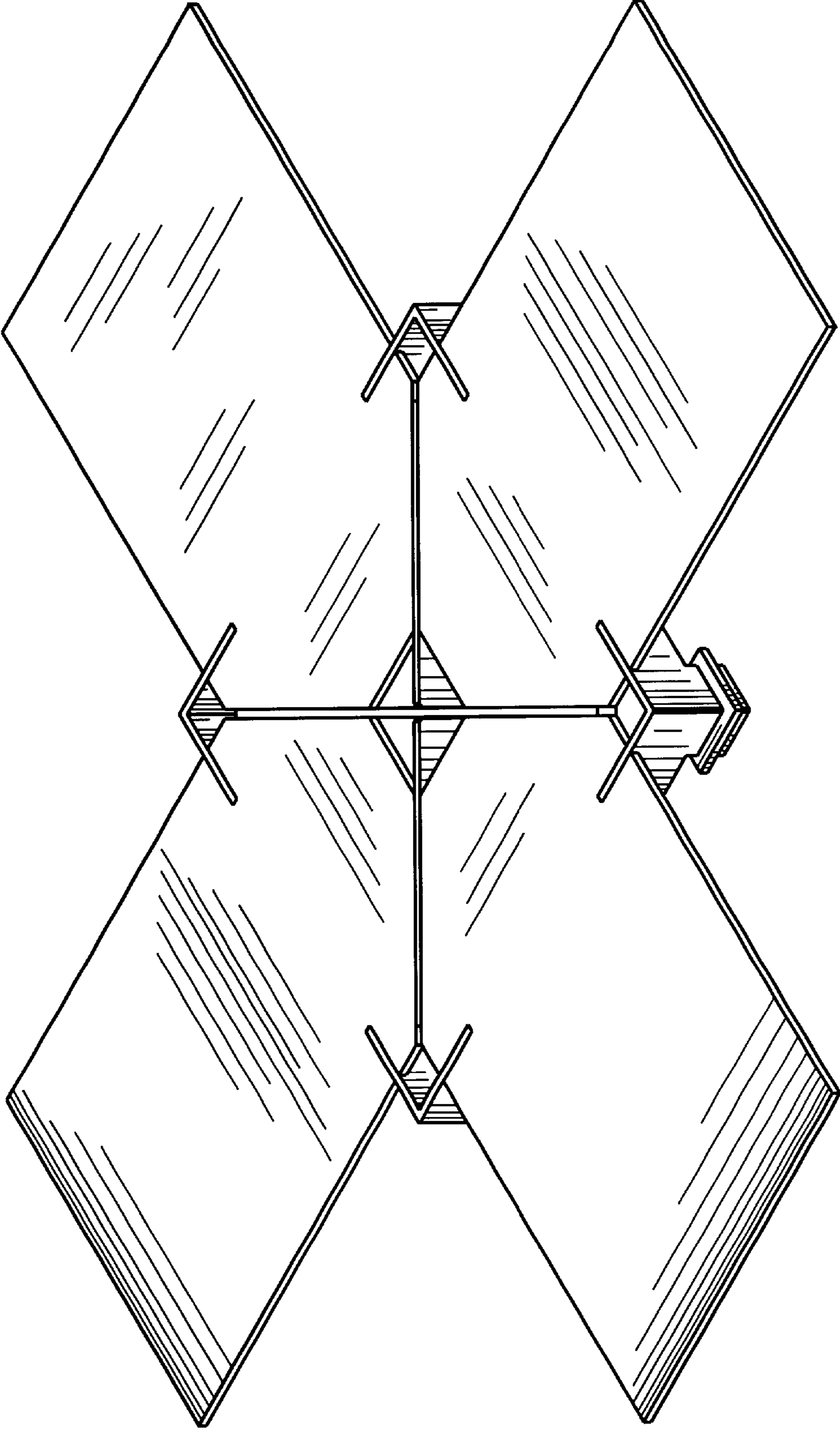

FIG. 8