



US00D525305S

(12) **United States Design Patent**  
**Carlson et al.**

(10) **Patent No.: US D525,305 S**  
(45) **Date of Patent: \*\* \*Jul. 18, 2006**

(54) **TAPE DISPENSER**

(75) Inventors: **Casey L. Carlson**, Edina, MN (US);  
**Daniel E. Siltberg**, White Bear  
Township, MN (US); **Scott D. Gullicks**,  
Apple Valley, MN (US); **Sigurdur**  
**Thorsteinsson**, Milan (IT)

(73) Assignee: **3M Innovative Properties Company**,  
St. Paul, MN (US)

(\*) Notice: This patent is subject to a terminal dis-  
claimer.

(\*\*) Term: **14 Years**

(21) Appl. No.: **29/223,802**

(22) Filed: **Feb. 18, 2005**

**Related U.S. Application Data**

(63) Continuation-in-part of application No. 29/208,731, filed on  
Jul. 2, 2004, now Pat. No. Des. 510,951.

(51) **LOC (8) Cl.** ..... **19-02**

(52) **U.S. Cl.** ..... **D19/69**

(58) **Field of Classification Search** ..... D19/67,  
D19/68, 69, 70; 156/523, 527, 577; 206/411;  
225/6, 19, 25, 39, 77; 242/588.1, 588.2, 588.3,  
242/588.6, 598.2, 598.5

See application file for complete search history.

(56) **References Cited**

**U.S. PATENT DOCUMENTS**

D116,599 S 9/1939 Reinecke

(Continued)

**OTHER PUBLICATIONS**

3M Product Pamphlet from 3M Office Supplies Division, A  
World of Difference, New Products, "Scotch® Pop-up/Roll  
Tape Combo Dispenser," p. 8©, 2002, printed in USA.

3M Product Pamphlet from 3M Office Supplies Division,  
Working Solutions Working for You, "Scotch® Pop-up/Roll  
Tape Combo Dispenser," p. 12©, 2003, printed in USA.

3M Product Pamphlet from 3M Stationery Products Divi-  
sion, Scotch® Transparent Tape, (6-page tri-fold)©, 2003,  
printed in USA.

3M Product Pamphlet from 3M Stationery Products Divi-  
sion, Scotch® Magic™ Tape, 2 pages©, 2002, printed in  
USA.

3M Product Pamphlet from 3M Stationery Products Divi-  
sion, Scotch® Gift Wrap Tape, 2 pages©, 2003, printed in  
USA.

Scotch brand Pop-up/Roll Tape Combo dispenser and pack-  
aging, manufactured by 3M Company, pp. 1-15. Product  
was on sale prior to Jul. 2, 2003.

*Primary Examiner*—Elizabeth A. Albert

(74) *Attorney, Agent, or Firm*—Trisha D. Adamson

(57) **CLAIM**

The ornamental design for a tape dispenser, as shown and  
described.

**DESCRIPTION**

FIG. 1 is a perspective view of a tape dispenser showing our  
new design;

FIG. 2 is a left side view of the tape dispenser illustrated in  
FIG. 1, the right side view being the mirror image thereof;  
FIG. 3 is a top view of the tape dispenser illustrated in FIG.  
1;

FIG. 4 is a bottom view of the tape dispenser illustrated in  
FIG. 1;

FIG. 5 is a front view of the tape dispenser illustrated in FIG.  
1; and,

FIG. 6 is a rear view of the tape dispenser illustrated in FIG.  
1.

The structure depicted by means of broken lines in the  
figures has been shown for illustrative purposes only and  
forms no part of the claimed design.

The drawings are lined for color; specifically diagonal lines  
represent green coloring and the elliptical shaped area  
surrounding the central hole without lining represents white  
coloring.

**1 Claim, 2 Drawing Sheets**

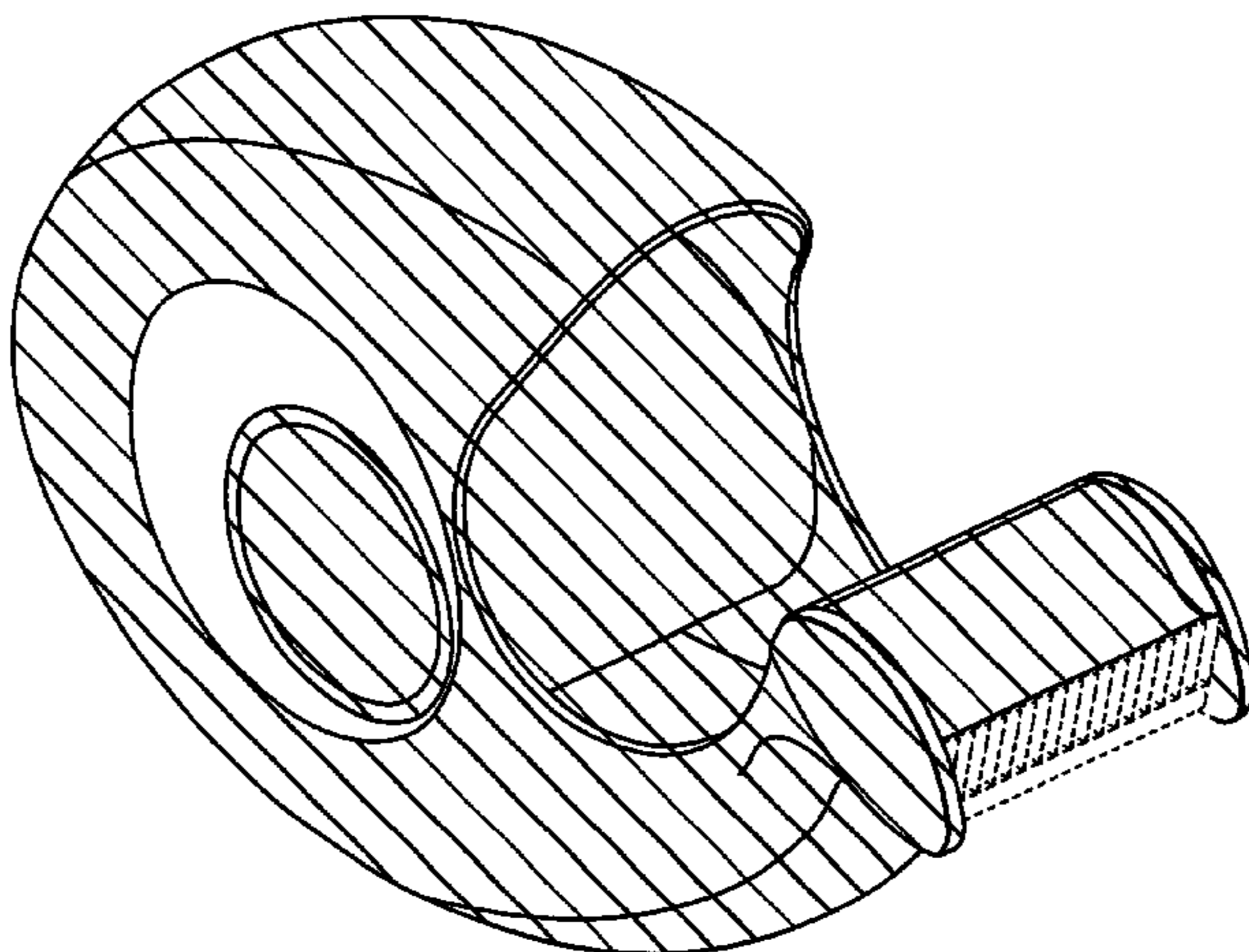

# US D525,305 S

Page 2

---

## U.S. PATENT DOCUMENTS

D118,629 S	1/1940	Reinecke		D332,629 S	*	1/1993	OH	.....	D19/69		
D144,215 S	3/1946	Preble		D336,492 S		6/1993	Samuelson				
D164,556 S	9/1951	Donkin		D342,092 S		12/1993	Samuelson				
2,604,166 A	*	7/1952	Turner	.....	83/611	D342,093 S	12/1993	Samuelson			
D170,429 S	9/1953	Reinecke		5,370,916 A	*	12/1994	Olsen	.....	428/40.1		
D177,224 S	3/1956	Gershen		5,794,815 A		8/1998	Carlson et al.				
3,498,512 A	*	3/1970	Golemon	.....	225/21	5,964,375 A	10/1999	Carlson et al.			
D242,452 S	*	11/1976	Brown, Sr.	.....	D19/69	5,996,932 A	*	12/1999	Wang	.....	242/598.5
4,437,854 A	*	3/1984	Knoop	.....	493/353	6,460,800 B1	*	10/2002	Watanabe et al.	.....	242/598.5
4,824,427 A	*	4/1989	Smillie, III	.....	493/353	D485,578 S	*	1/2004	Chandaria	.....	D19/69
D315,576 S	3/1991	En		2004/0124305 A1	*	7/2004	Huang	.....	242/588.6		
5,083,717 A	*	1/1992	Samuelson et al.	.....	242/588.6	2004/0151901 A1	*	8/2004	Pearson et al.	.....	428/343
D331,262 S	*	11/1992	O'Brien	.....	D19/69						

\* cited by examiner

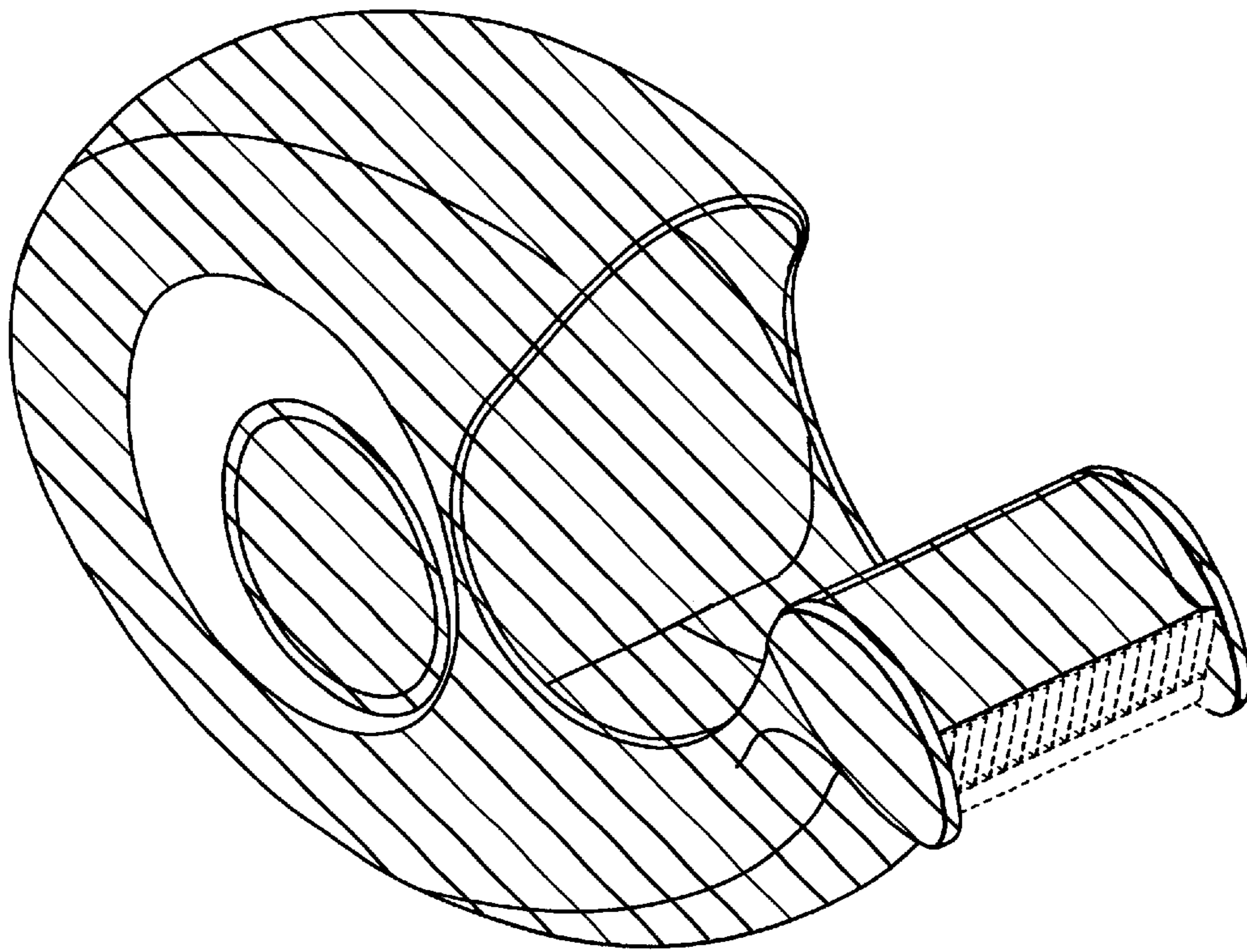

**Fig. 1**

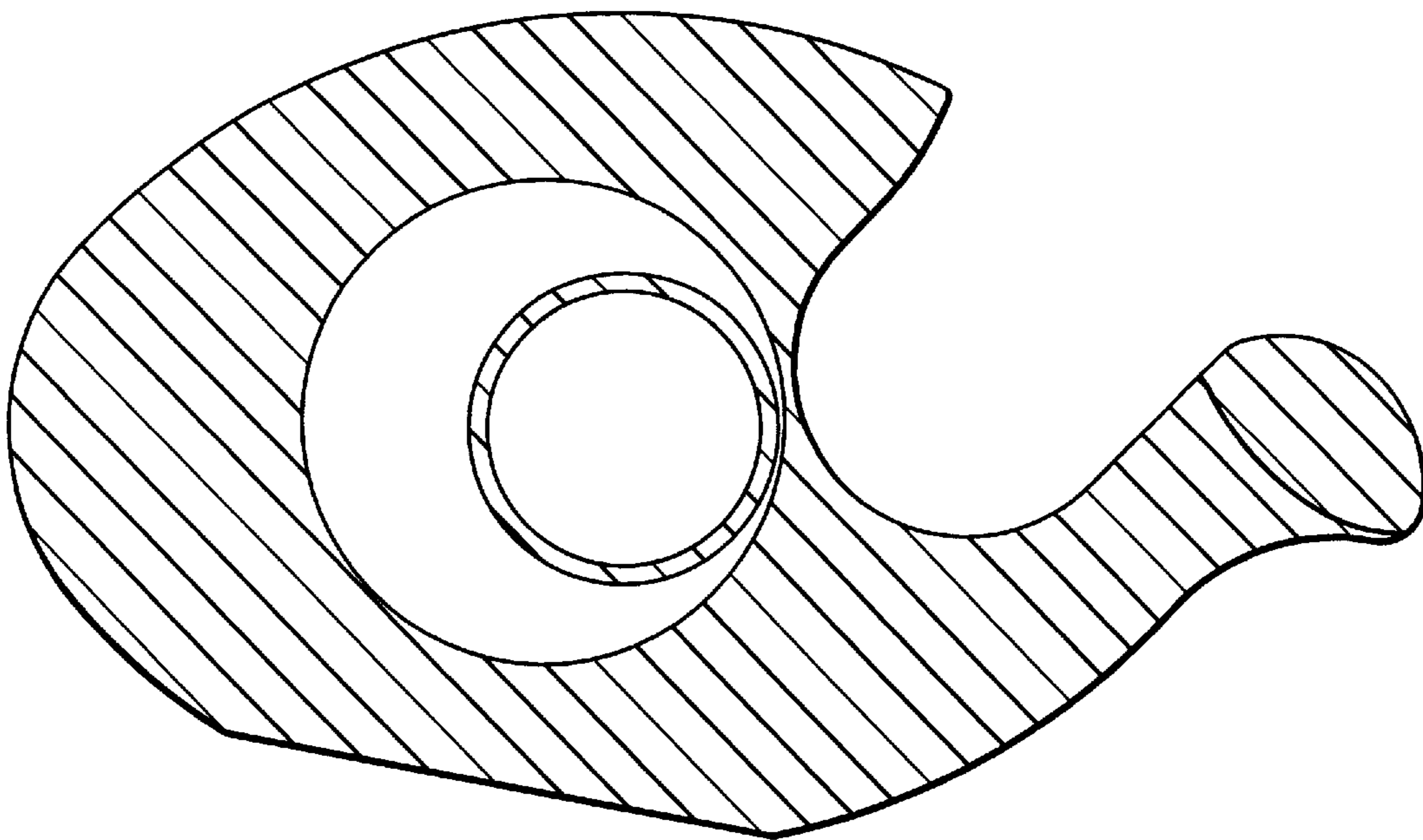

**Fig. 2**

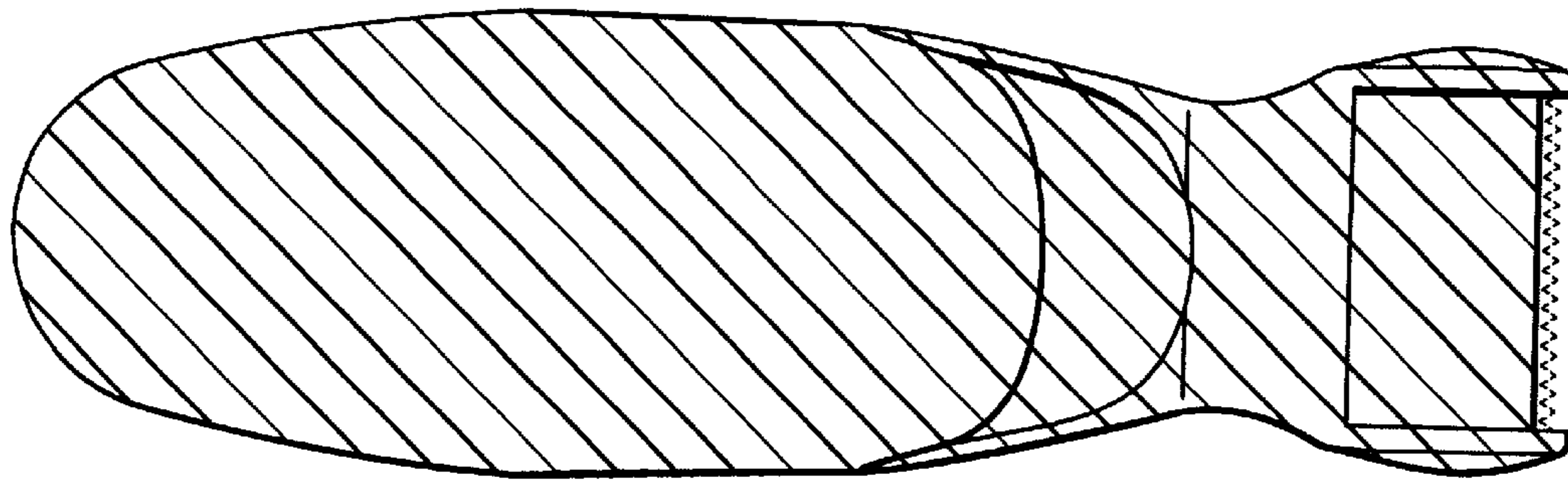

**Fig. 3**

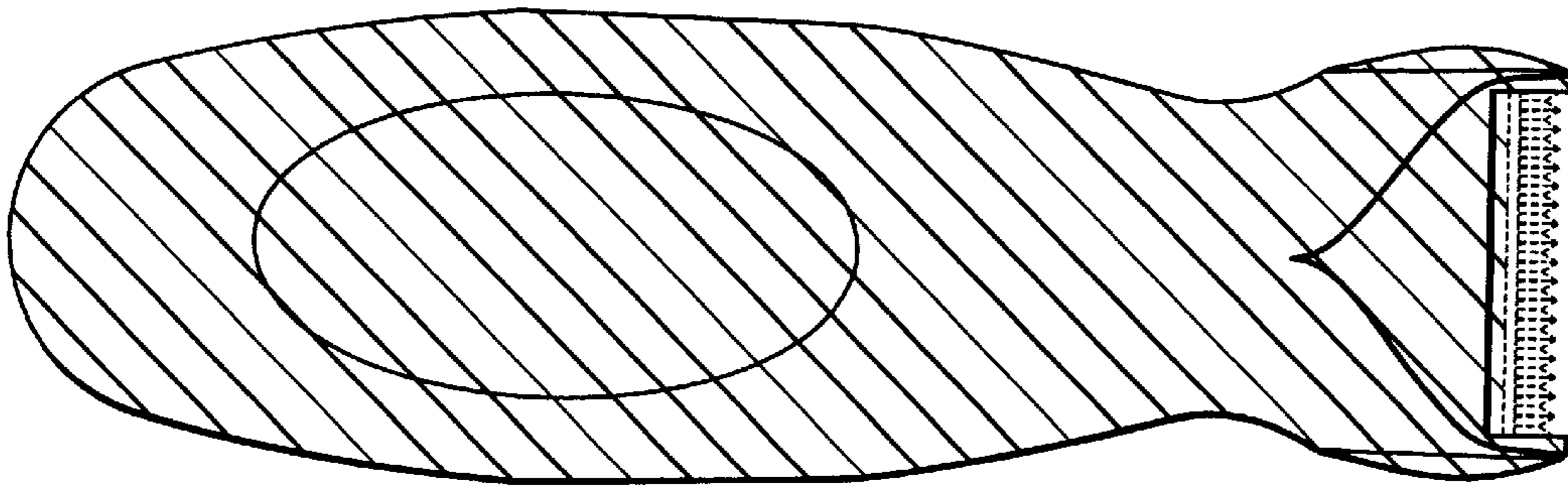

**Fig. 4**

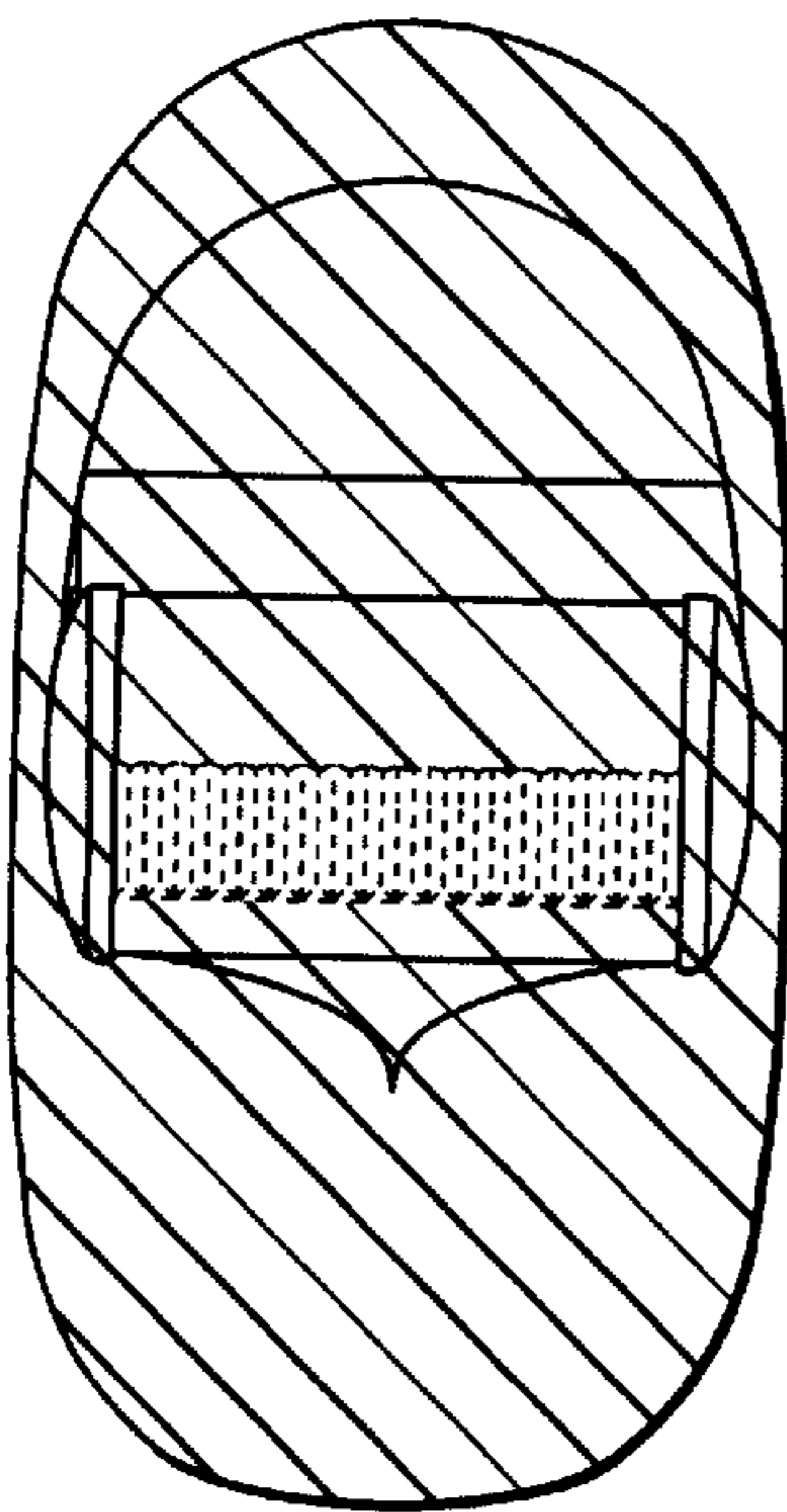

**Fig. 5**

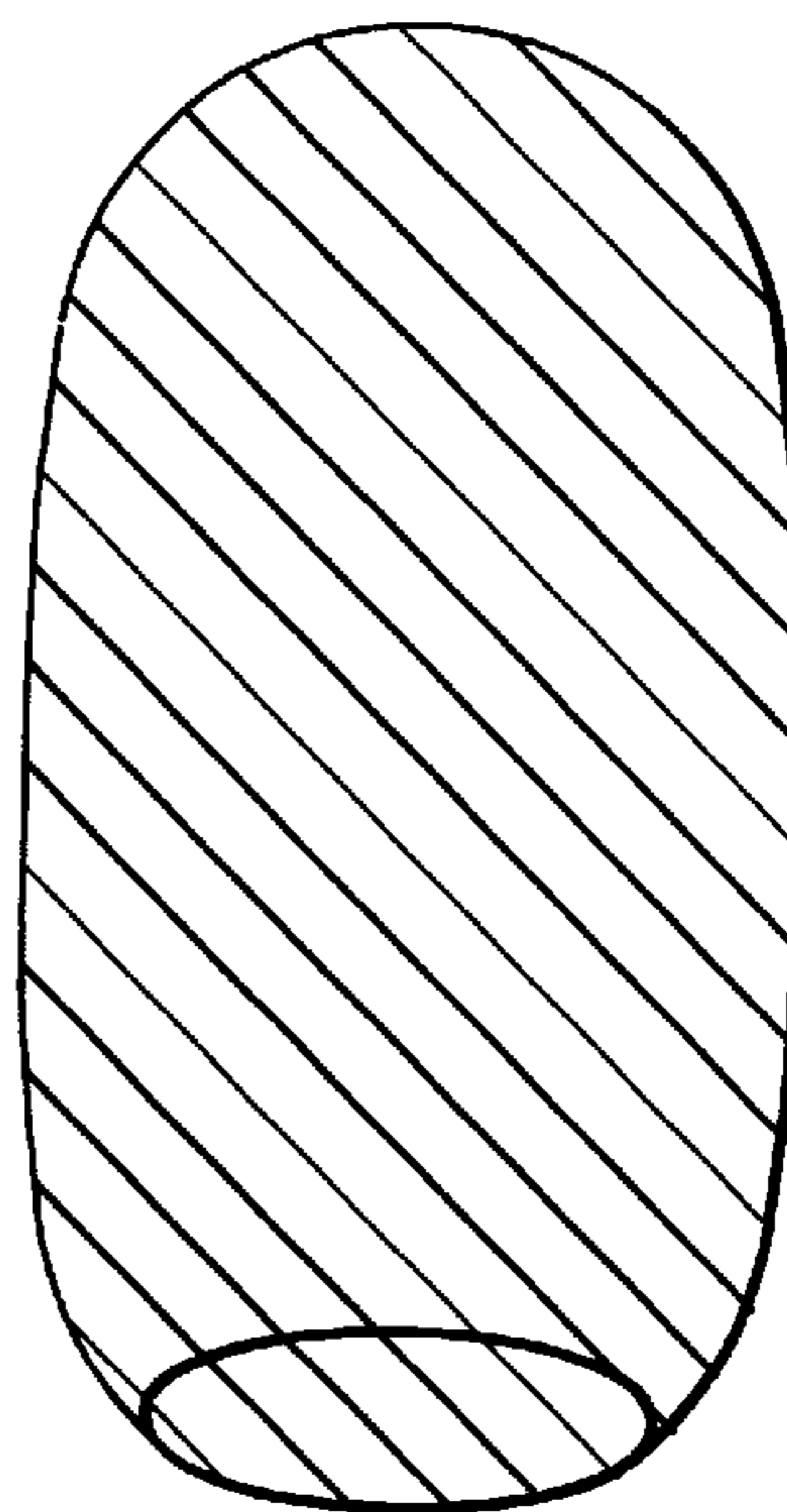

**Fig. 6**