



US00D525157S

(12) **United States Design Patent**
Wrubel

(10) **Patent No.:** **US D525,157 S**

(45) **Date of Patent:** **** Jul. 18, 2006**

(54) **TIRE PRESSURE GAUGE**

(75) Inventor: **Daniel Wrubel**, Grandville, MI (US)

(73) Assignee: **EQAir, LLC**, Grandville, MI (US)

(**) Term: **14 Years**

(21) Appl. No.: **29/241,496**

(22) Filed: **Oct. 27, 2005**

(51) **LOC (8) Cl.** **10-04**

(52) **U.S. Cl.** **D10/86**

(58) **Field of Classification Search** D10/86,
D10/85; 73/732, 744, 742, 717, 741, 146.3,
73/146.8; 116/34 R, 272; 702/140

See application file for complete search history.

(56) **References Cited**

U.S. PATENT DOCUMENTS

D212,385 S	*	10/1968	Yamada	D10/86
D353,113 S	*	12/1994	Cook-Martin	D10/85
D354,449 S	*	1/1995	Yoo	D10/85

* cited by examiner

Primary Examiner—Antoine D. Davis

Assistant Examiner—Patricia Palasik

(74) *Attorney, Agent, or Firm*—Van Dyke, Gardner, Linn & Burkhardt, LLP

(57) **CLAIM**

The ornamental design for the tire pressure gauge, as shown and described.

DESCRIPTION

FIG. 1 is an upper front perspective view of a tire pressure gauge in accordance with the present invention; FIG. 2 is an upper rear perspective view thereof; FIG. 3 is a lower front perspective view thereof; FIG. 4 is a lower rear perspective view thereof; FIG. 5 is a front elevation thereof; FIG. 6 is a rear elevation thereof; FIG. 7 is a side elevation thereof; FIG. 8 is an opposite side elevation thereof; FIG. 9 is a top plan view thereof; and, FIG. 10 is a bottom plan view thereof.

The dashed lines in FIGS. 1–10 represent pressure fittings for the tire pressure gauge of the present invention and form no part of the claimed design.

1 Claim, 10 Drawing Sheets

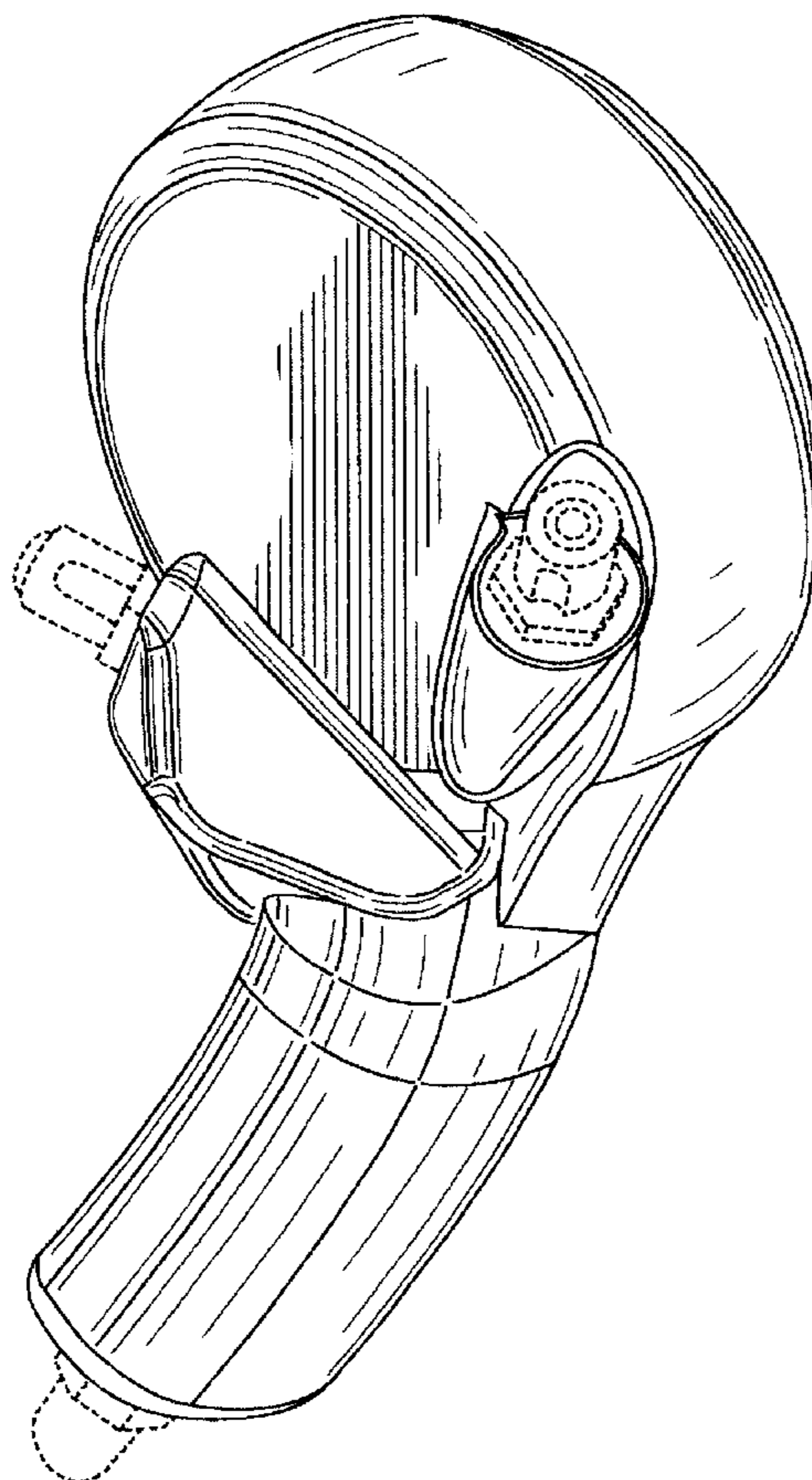

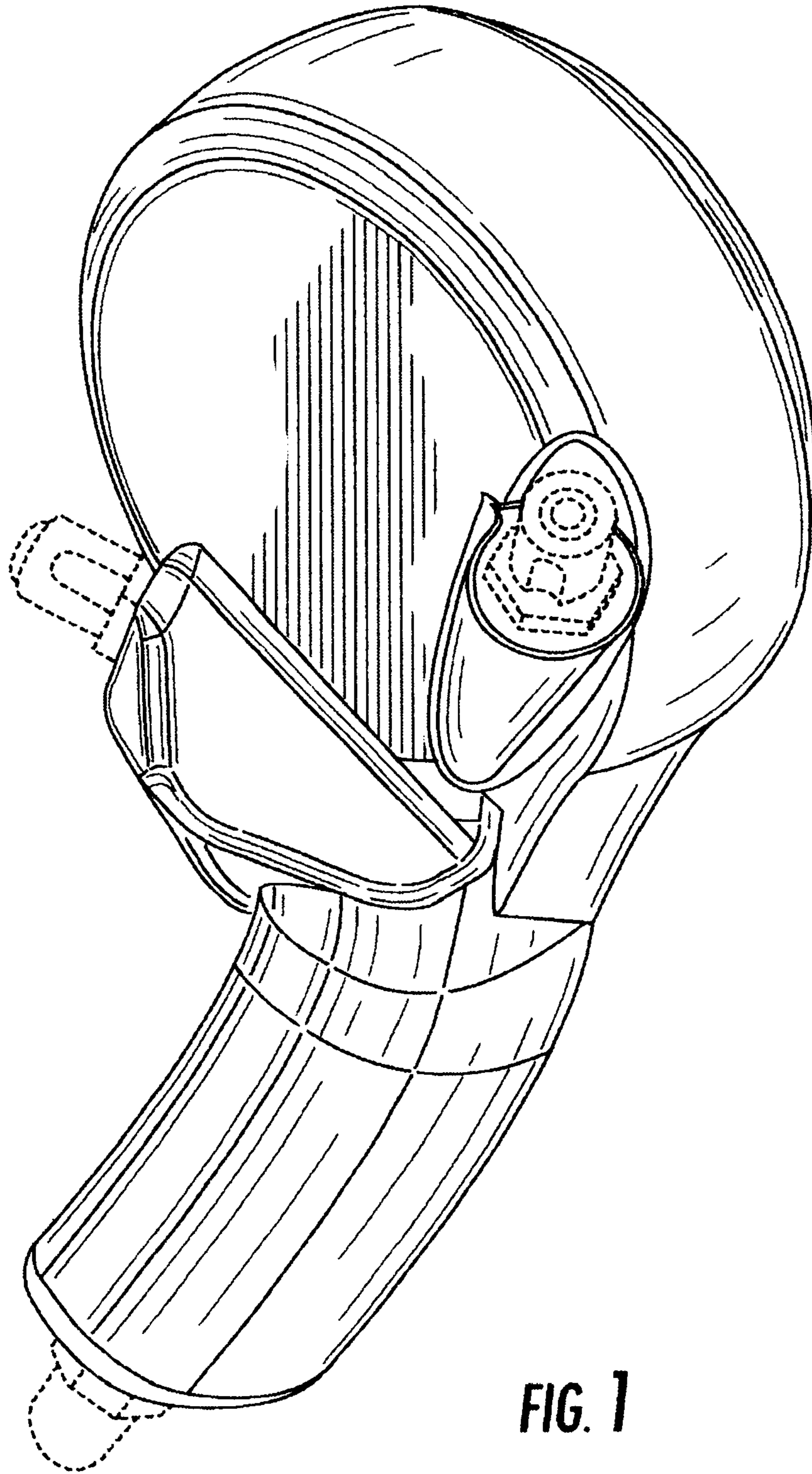

FIG. 1

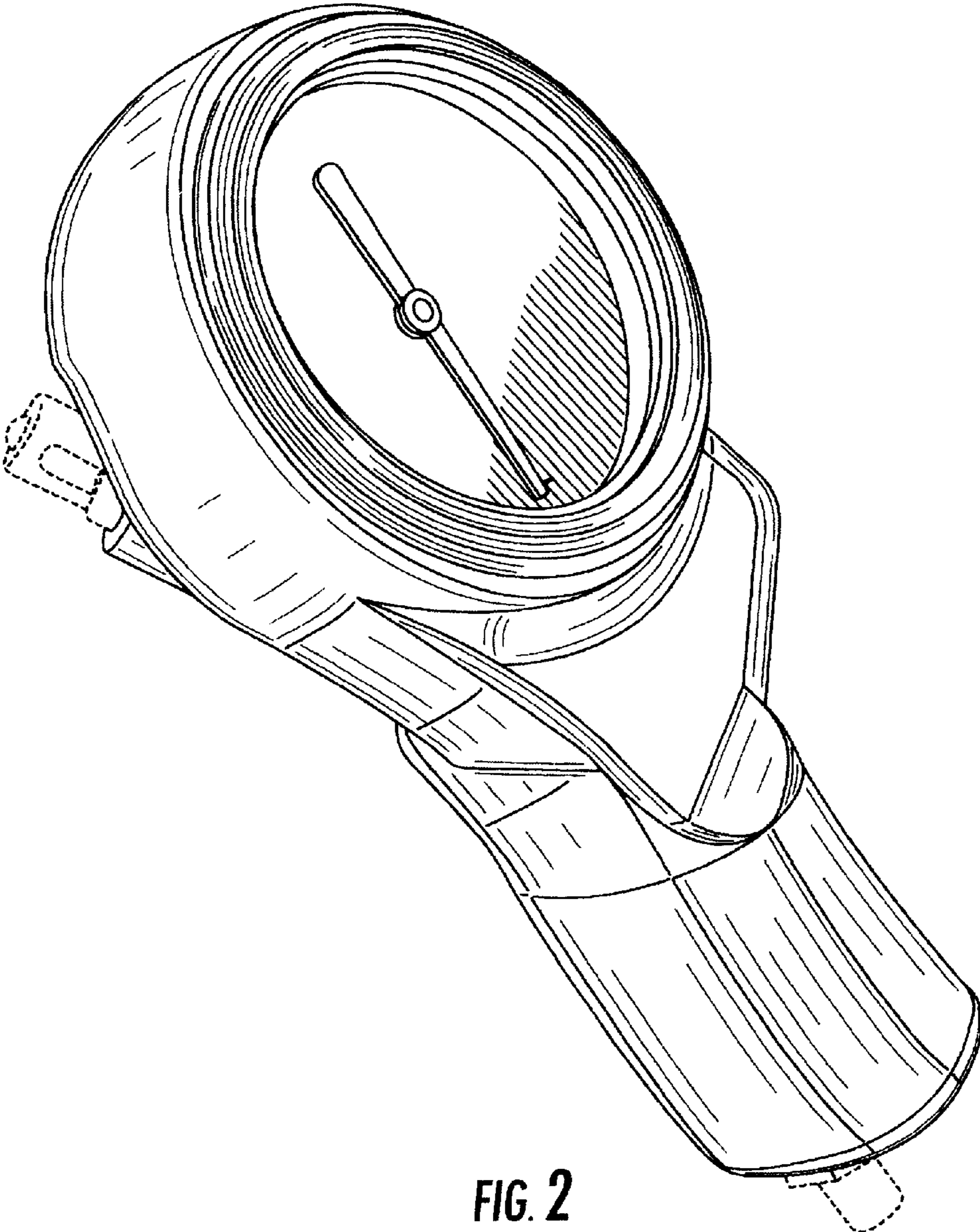

FIG. 2

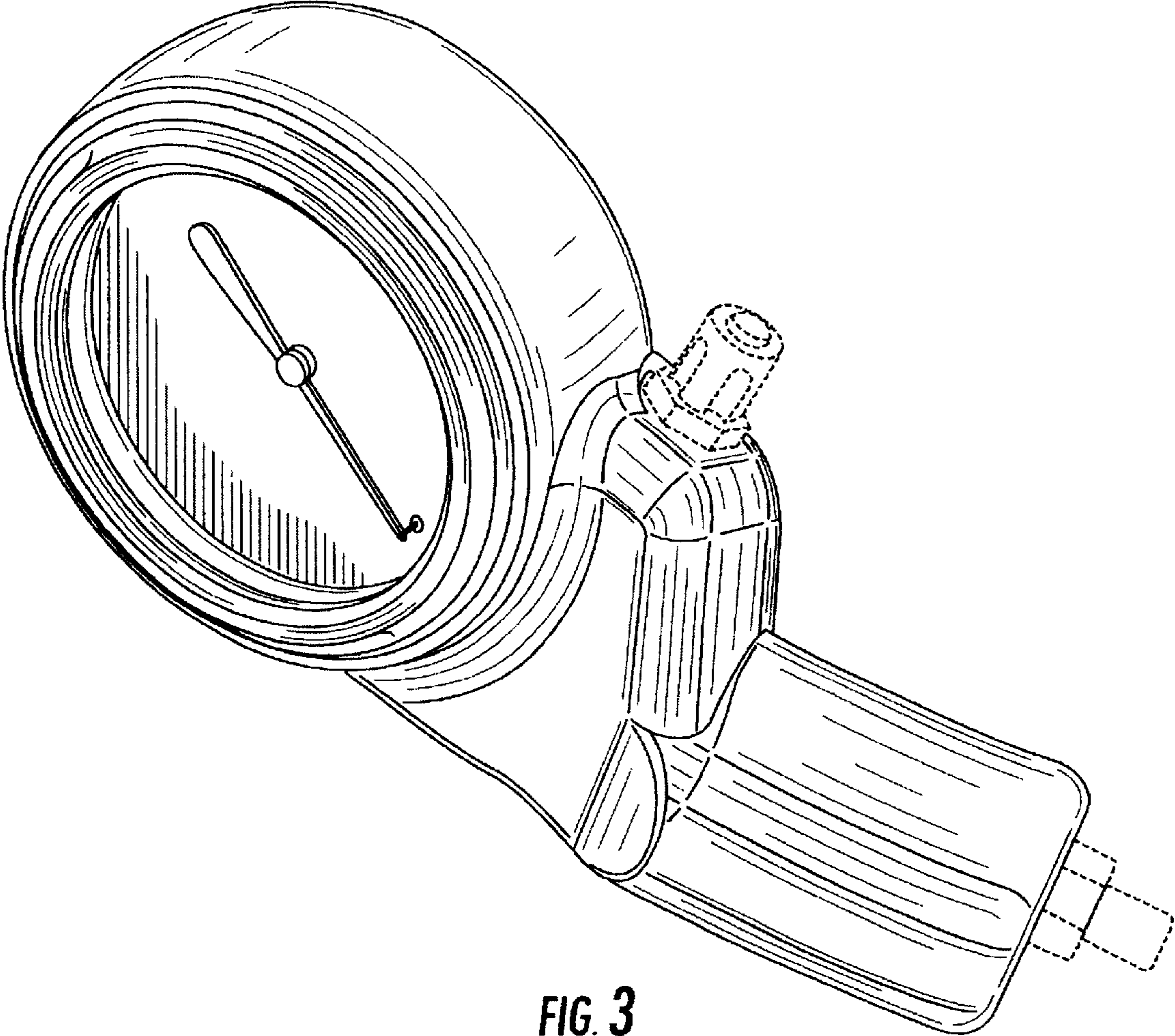

FIG. 3

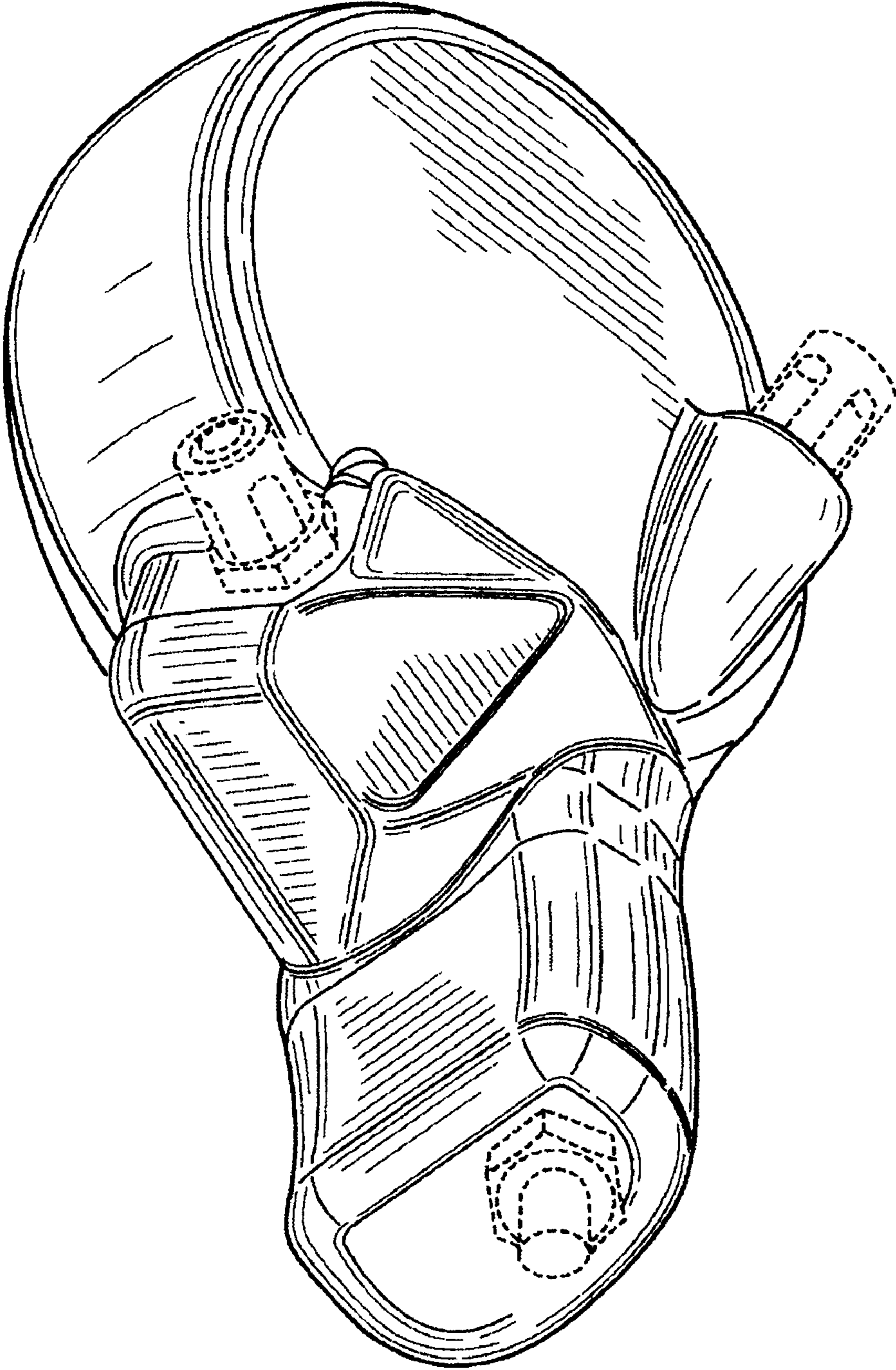

FIG. 4

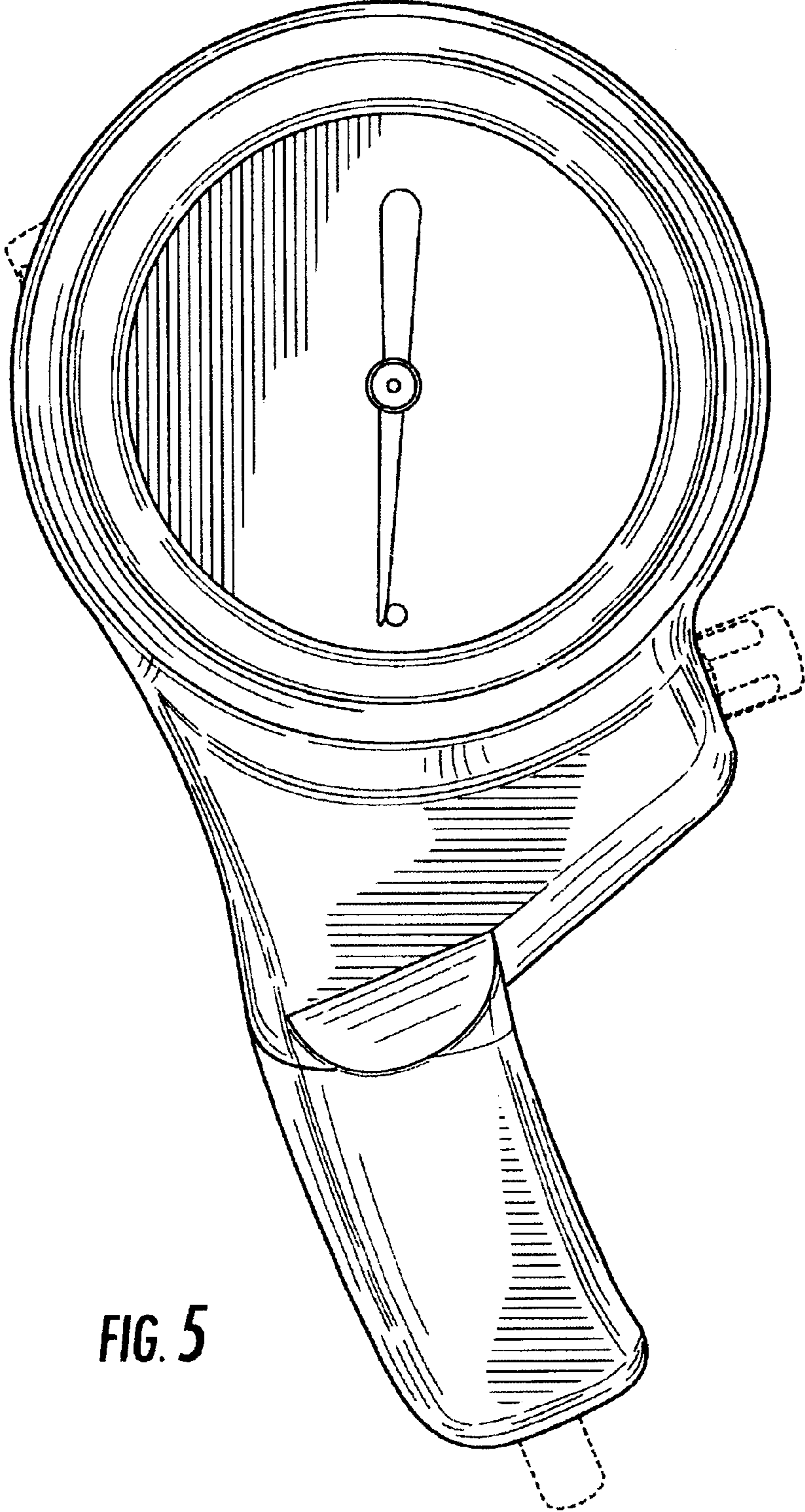

FIG. 5

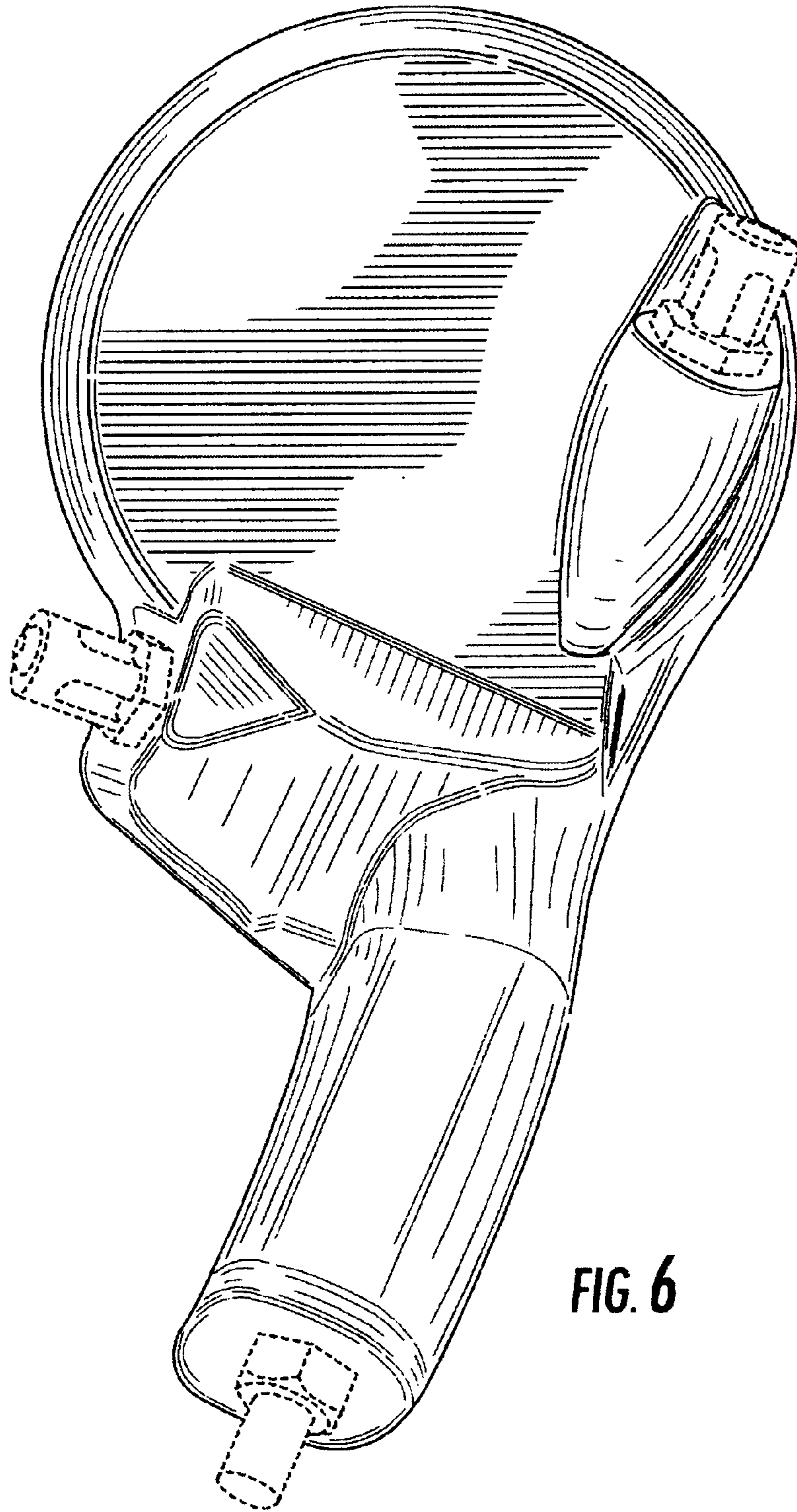

FIG. 6

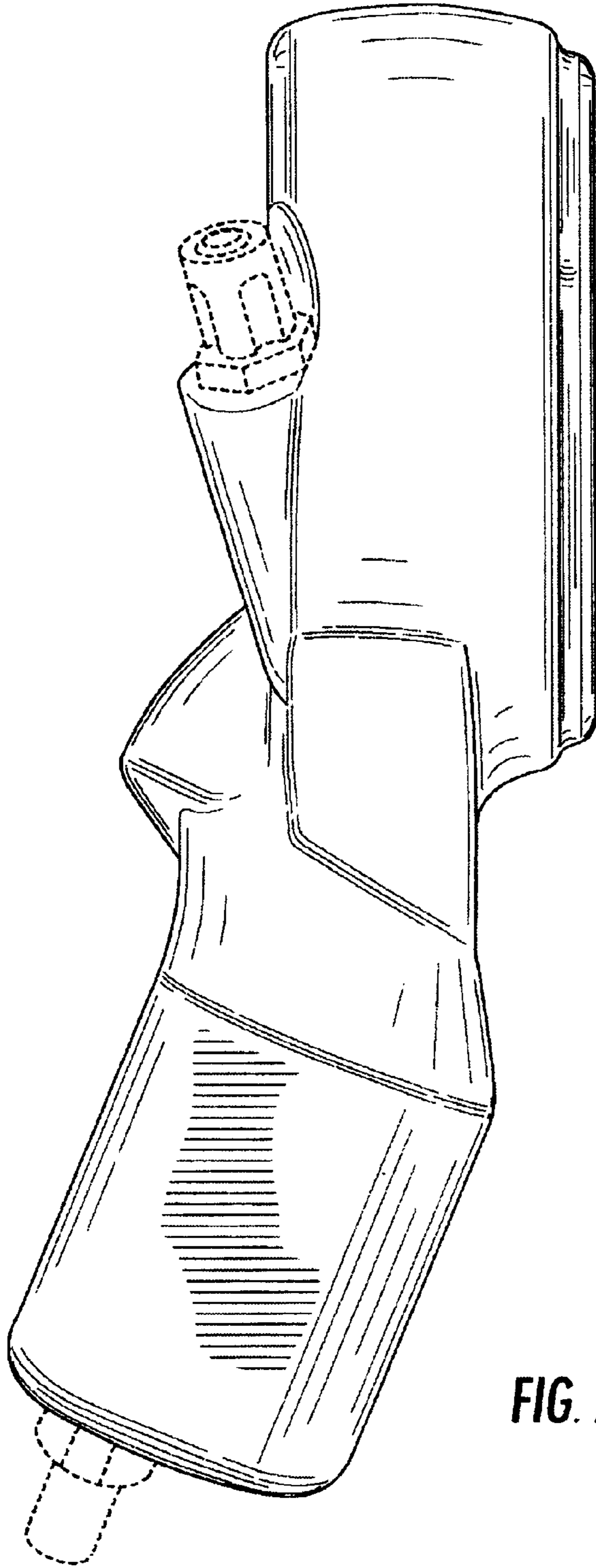

FIG. 7

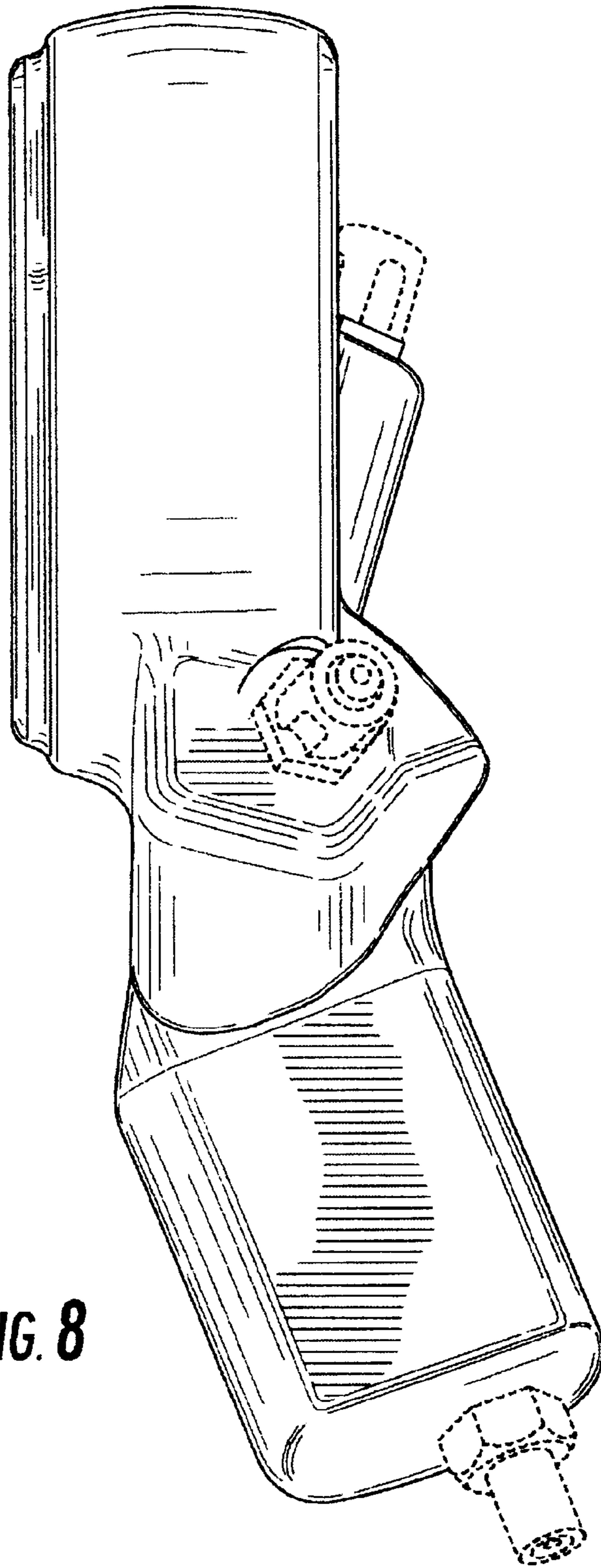

FIG. 8

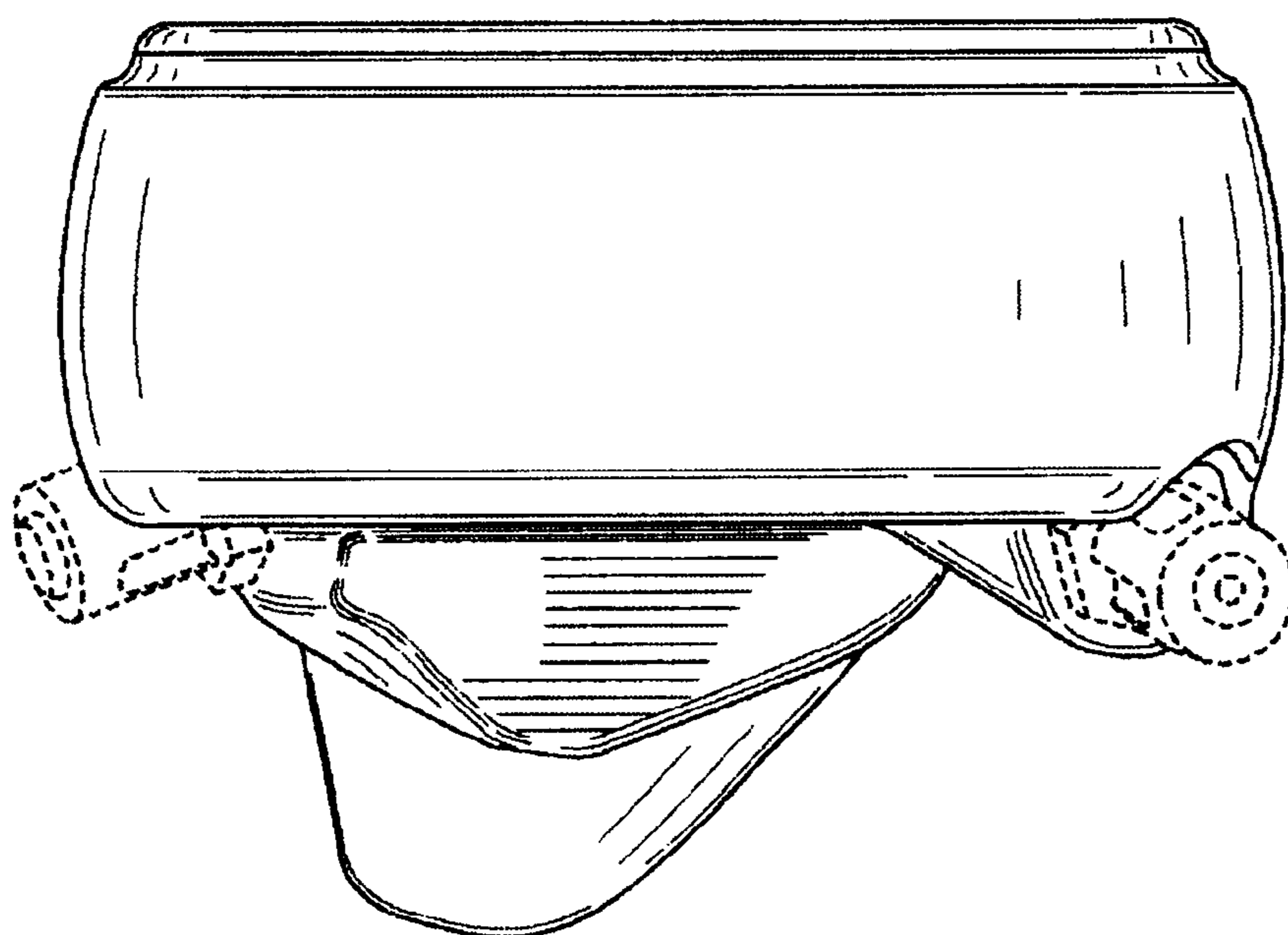

FIG. 9

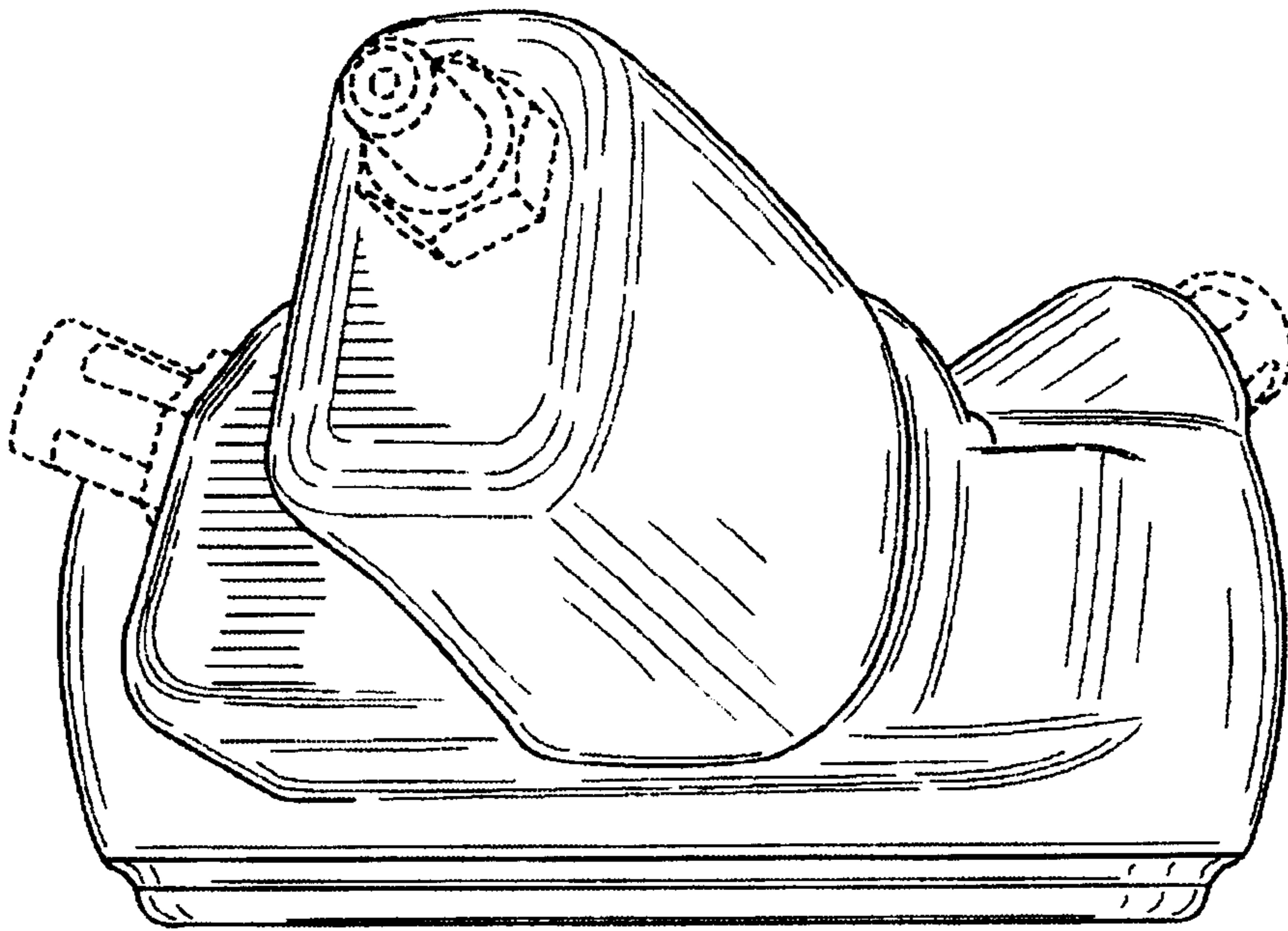

FIG. 10