



US00D525128S

(12) **United States Design Patent**
Dibnah et al.

(10) **Patent No.:** **US D525,128 S**

(45) **Date of Patent:** **** Jul. 18, 2006**

(54) **INSERT**

6,425,482 B1 * 7/2002 Chiang 206/349
D511,452 S * 11/2005 Dibnah et al. D9/415

(75) Inventors: **Carl Dibnah**, Hull (GB); **Andrew Robert McLeish**, Sheffield (GB)

* cited by examiner

(73) Assignee: **Reckitt Benckiser (UK) Limited**, Slough (GB)

Primary Examiner—Robert M. Spear
Assistant Examiner—Susan Bennett Hattan
(74) *Attorney, Agent, or Firm*—Norris McLaughlin & Marcus PA

(**) Term: **14 Years**

(21) Appl. No.: **29/205,262**

(57) **CLAIM**

(22) Filed: **May 12, 2004**

The ornamental design for an insert, as shown and described.

(30) **Foreign Application Priority Data**

DESCRIPTION

Nov. 15, 2004 (GB) 3015204

(51) **LOC (8) Cl.** **09-07**

(52) **U.S. Cl.** **D9/456; D9/499**

(58) **Field of Classification Search** D9/457,
D9/456, 455, 451, 433, 432, 424, 418, 415;
D20/42, 40, 22; 40/789, 787, 124.11, 124.01;
206/775, 769, 763, 760, 703, 6.1, 5, 462,
206/461, 440, 395, 391, 349, 225
See application file for complete search history.

FIG. 1 is a perspective view of the front of an insert showing our new design;
FIG. 2 is an elevational view of the front thereof;
FIG. 3 is an elevational view of a side thereof;
FIG. 4 is a plan view of the top thereof;
FIG. 5 is an elevational view of the rear thereof;
FIG. 6 is an elevational view of the other side thereof;
FIG. 7 is a plan view of the bottom thereof; and,
FIG. 8 is a plan view of the insert in an unfolded configuration.

(56) **References Cited**

The broken lines in the drawings indicate fold lines and are included in the claimed design.

U.S. PATENT DOCUMENTS

D271,283 S * 11/1983 Taylor D9/415

1 Claim, 4 Drawing Sheets

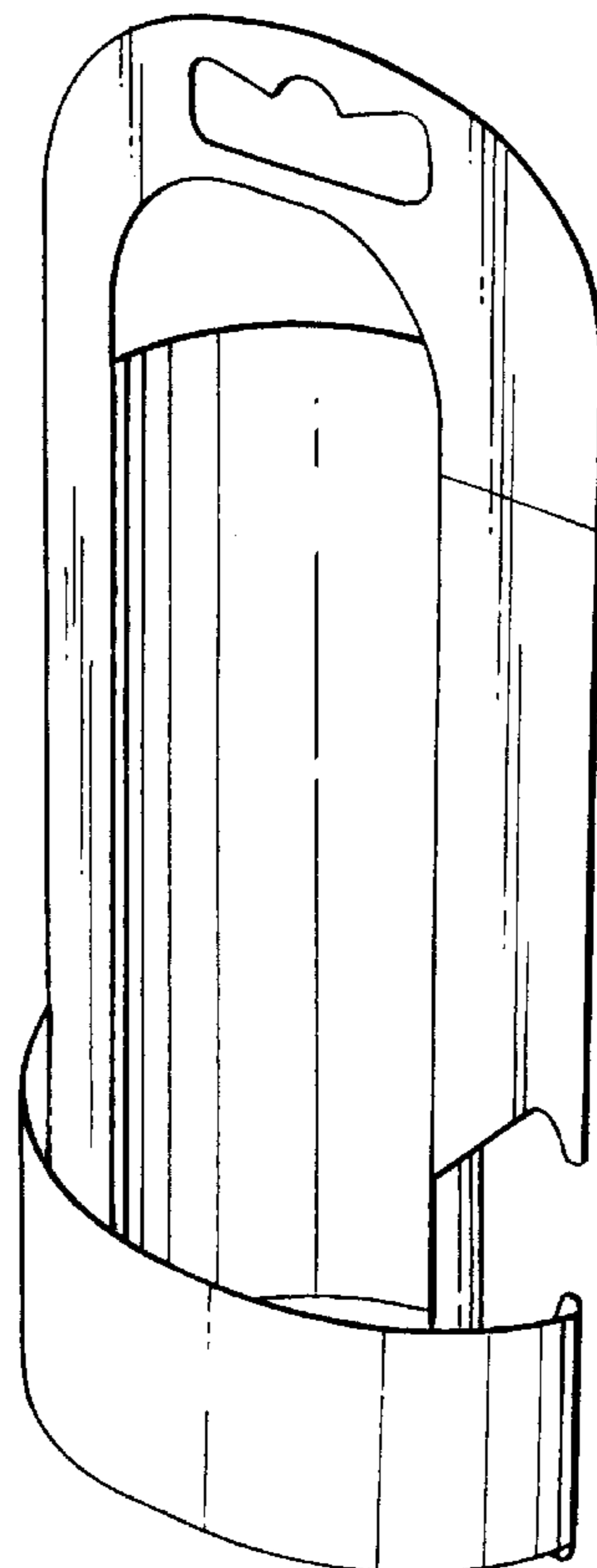

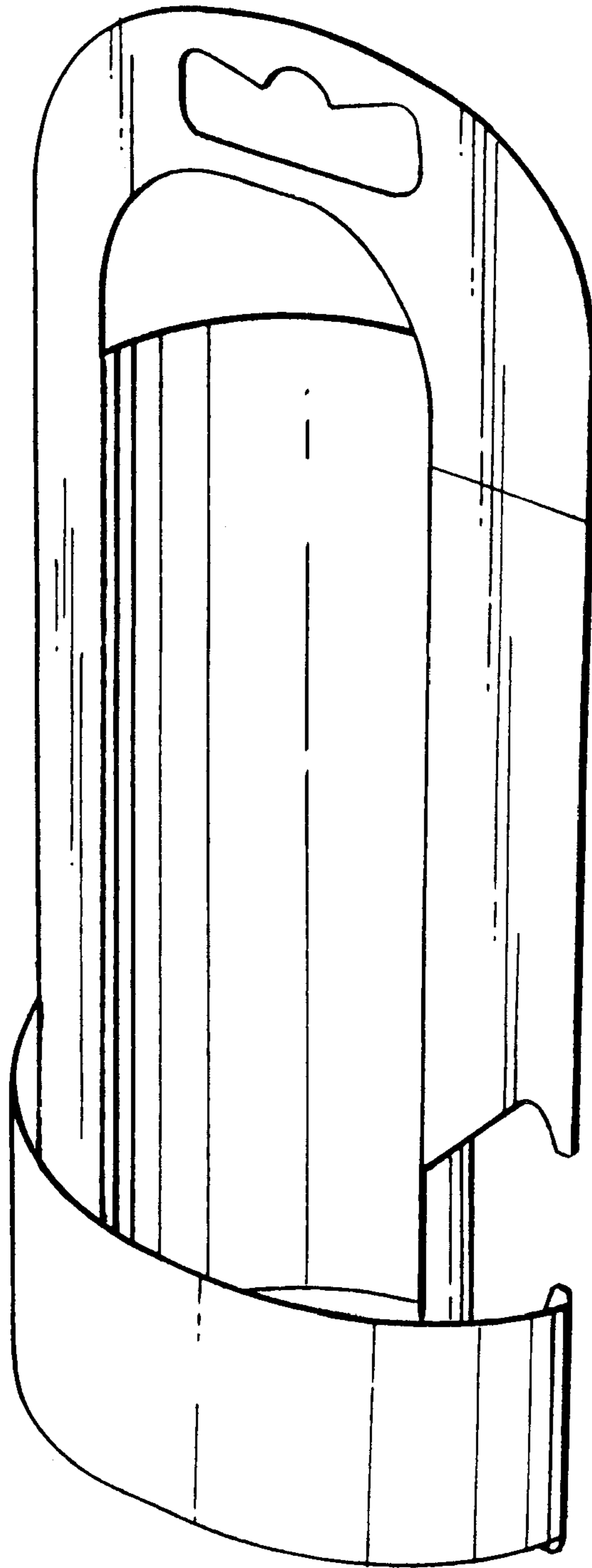

Fig. 1.

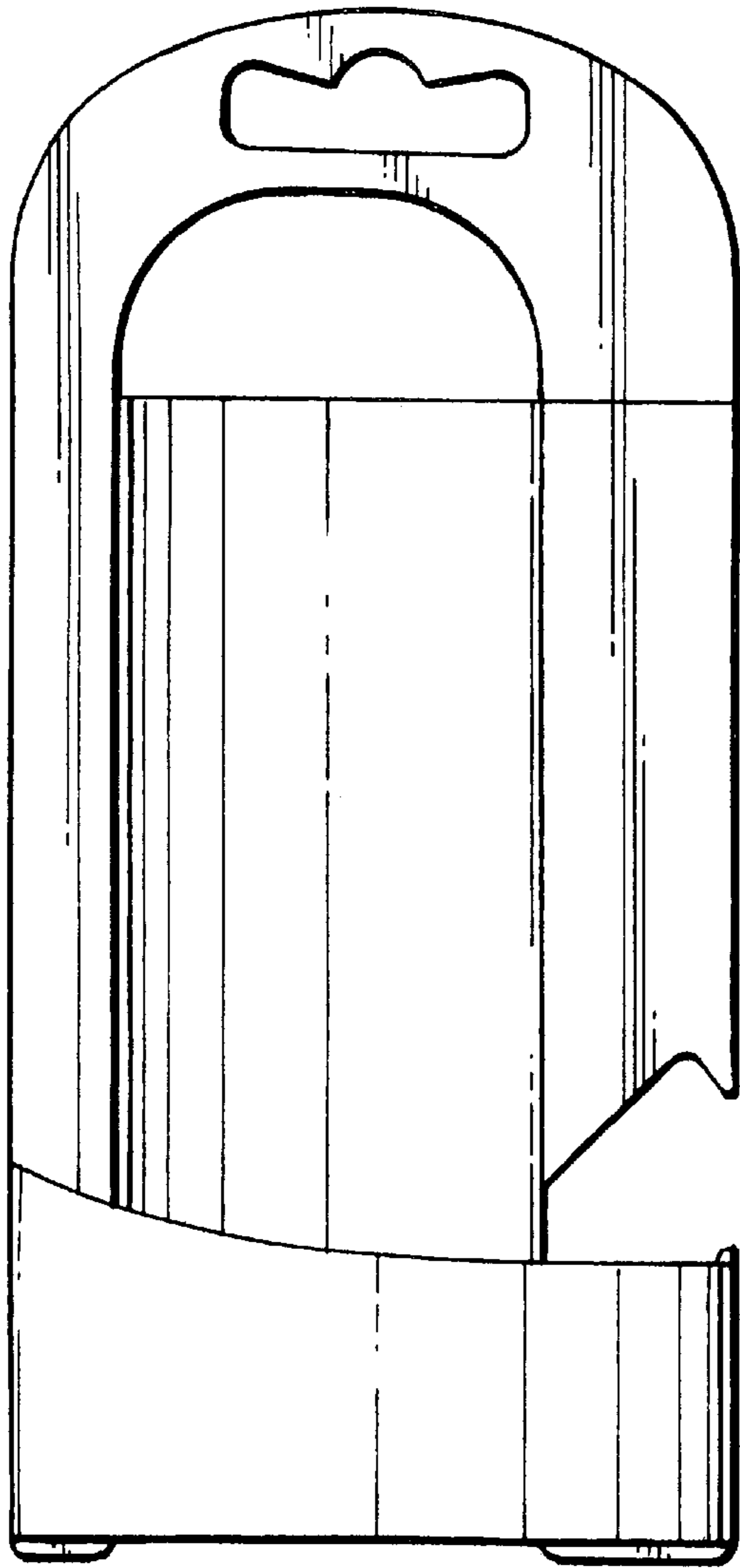

Fig.2.



Fig.3.

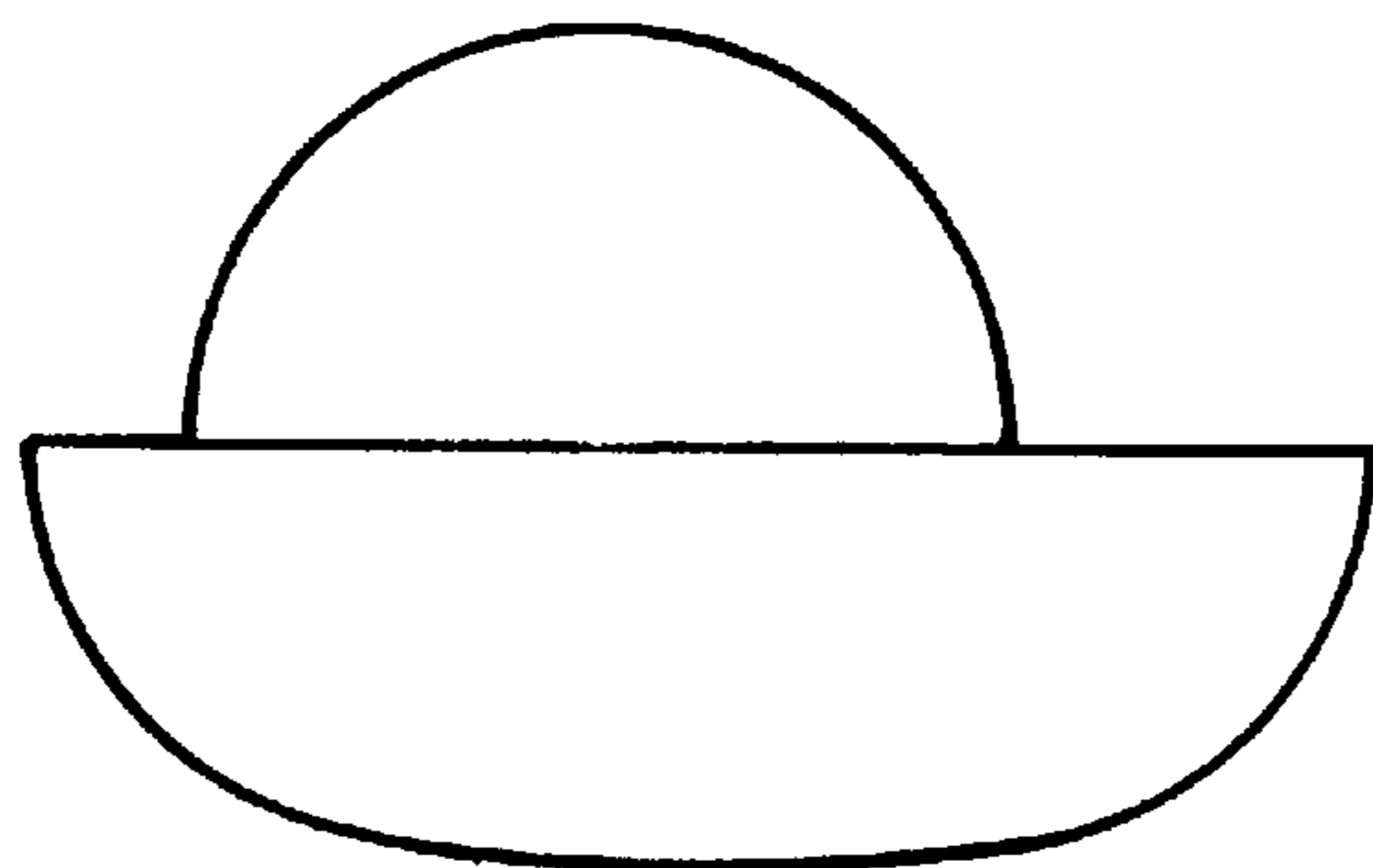

Fig.4.

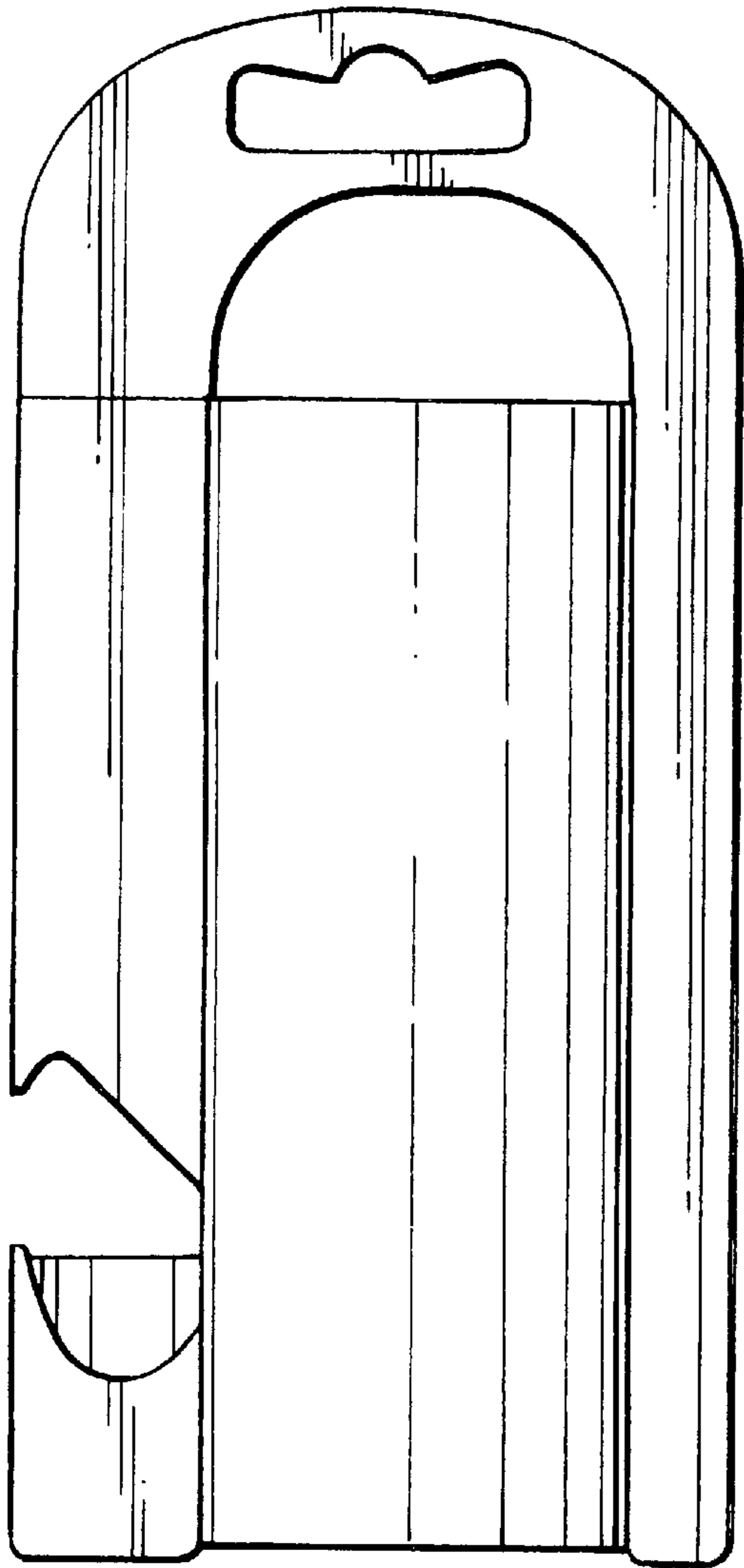

Fig. 5.

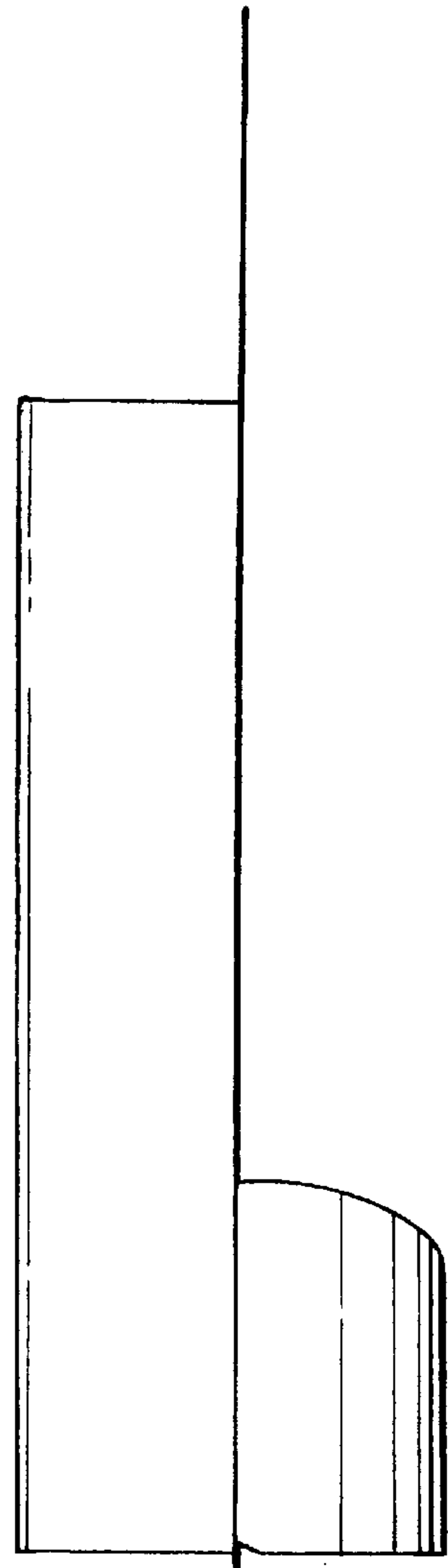

Fig. 6.

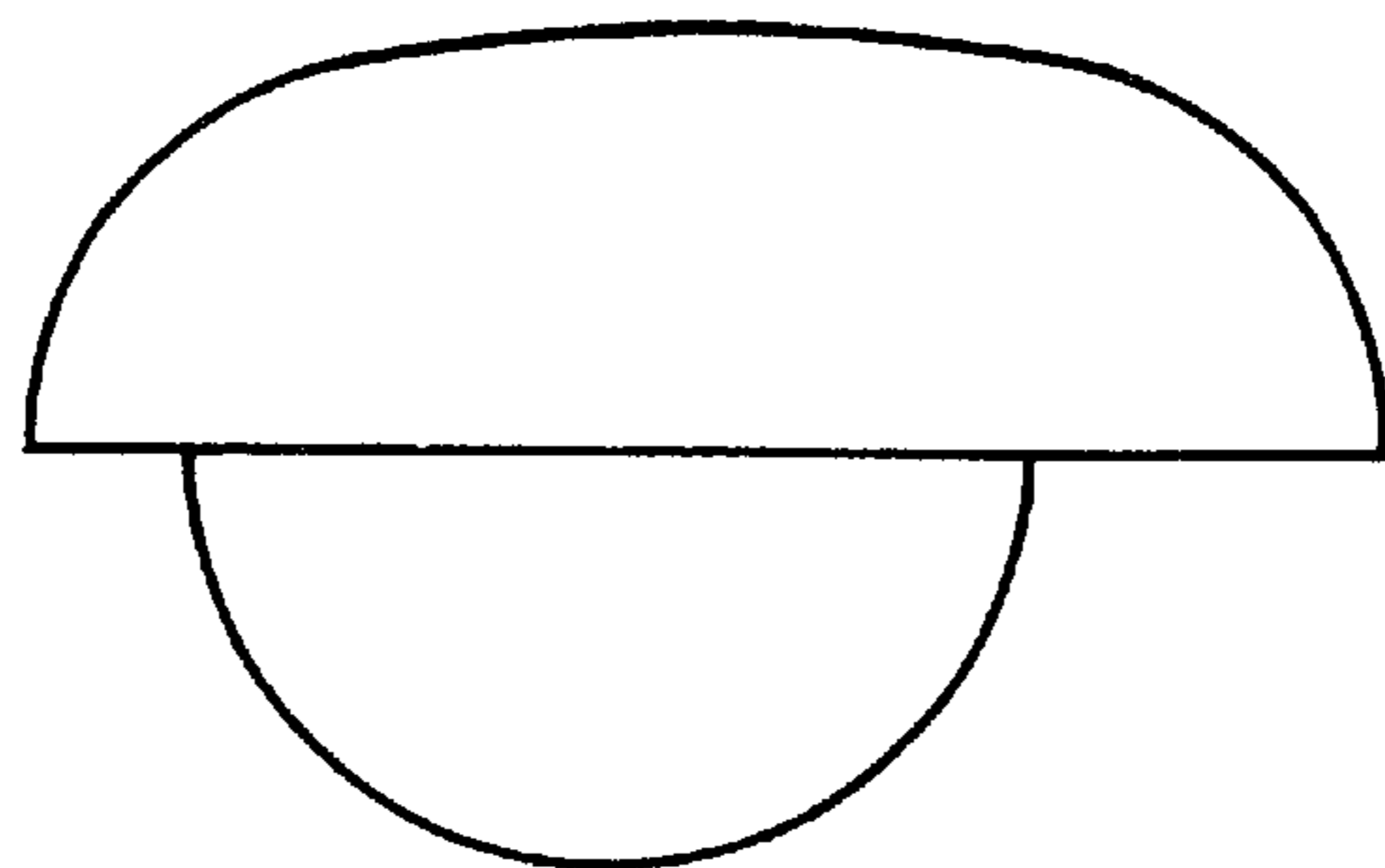

Fig. 7.

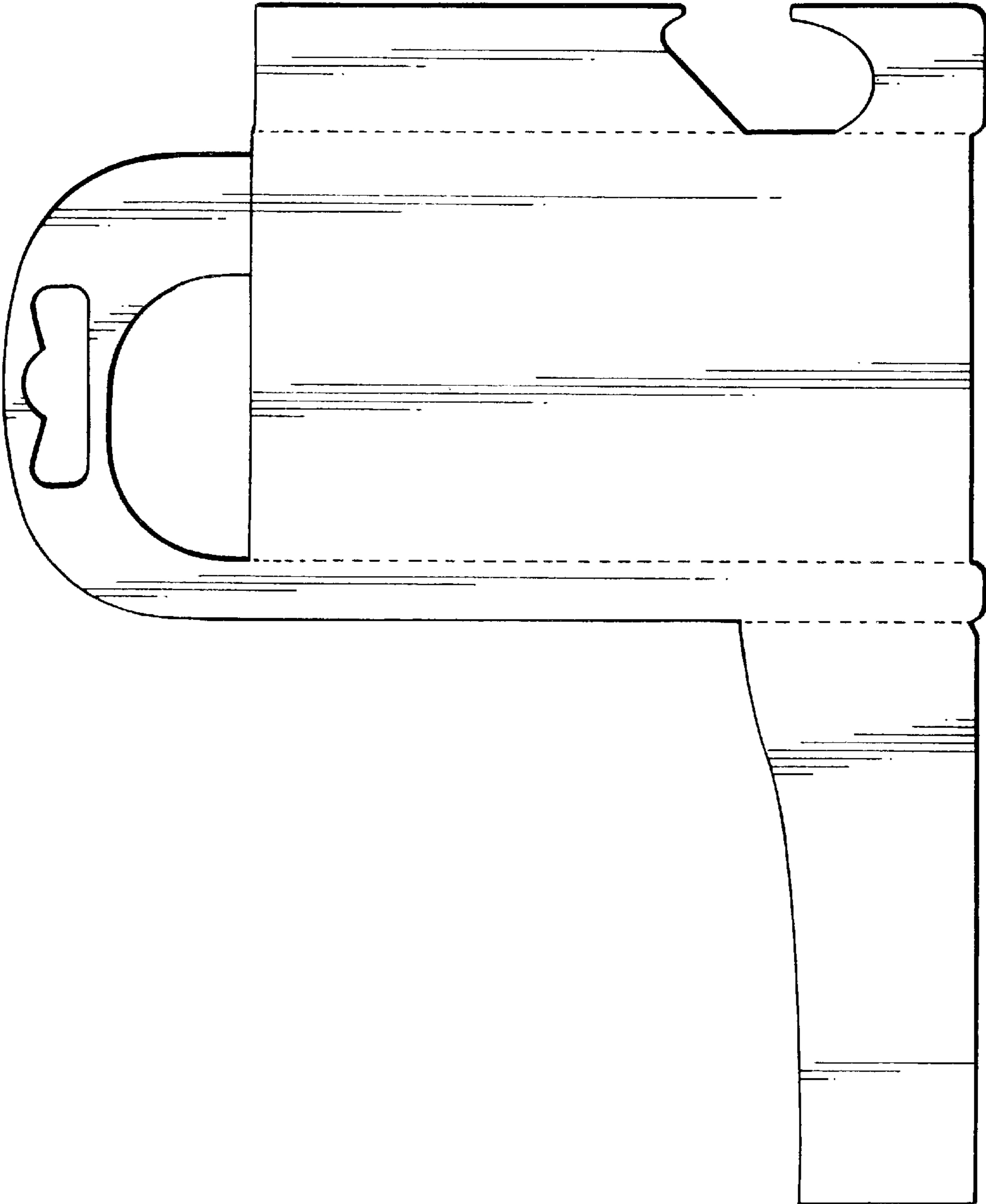

Fig. 8.