



US00D525085S

(12) **United States Design Patent**
Krieger et al.

(10) **Patent No.:** **US D525,085 S**

(45) **Date of Patent:** **** Jul. 18, 2006**

(54) **TRAVEL COOLER AND WARMER**

D480,274 S * 10/2003 Yuen D7/605
D480,275 S * 10/2003 Yuen D7/605

(75) Inventors: **Michael Krieger**, Miami Beach, FL
(US); **Kevin Ellsworth**, Hollywood, FL
(US)

OTHER PUBLICATIONS

U.S. Appl. No. 29/228,838 filed Apr. 29, 2005.
U.S. Appl. No. 29/228,839 filed Apr. 29, 2005.
U.S. Appl. No. 29/228,836 filed Apr. 29, 2005.

(73) Assignee: **Vector Products, Inc.**, Ft. Lauderdale,
FL (US)

* cited by examiner

(**) Term: **14 Years**

Primary Examiner—Terry A. Wallace

(21) Appl. No.: **29/228,837**

(74) *Attorney, Agent, or Firm*—Venable LLP; Robert
Kinberg; Manni Li

(22) Filed: **Apr. 29, 2005**

(57) **CLAIM**

(51) **LOC (8) Cl.** **07-01**

The ornamental design for a travel cooler and warmer, as
shown and described.

(52) **U.S. Cl.** **D7/605**

(58) **Field of Classification Search** D7/605–608,
D7/709, 710; D15/81; 62/457.1–457.7, 371,
62/372, 3.62, 3.64; 220/592.16, 592.17, 592.2,
220/592.23–592.27, 915.1, 915.2; D12/423,
D12/424

DESCRIPTION

See application file for complete search history.

FIG. 1 is a perspective view form the front-top-right side of
the travel cooler and warmer showing our new design;
FIG. 2 is a front view of the design shown in FIG. 1;
FIG. 3 is a rear view of the design shown in FIG. 1;
FIG. 4 is a left side view of the design shown in FIG. 1;
FIG. 5 is a right side view of the design shown in FIG. 1;
FIG. 6 is a top view of the design shown in FIG. 1; and,
FIG. 7 is a bottom view of the design shown in FIG. 1.

(56) **References Cited**

U.S. PATENT DOCUMENTS

4,274,262 A * 6/1981 Reed et al. 62/3.64
D400,053 S * 10/1998 Coffee et al. D7/605
D417,126 S * 11/1999 Arnfelt D7/605
D459,636 S * 7/2002 Krieger et al. D7/605
D462,878 S * 9/2002 Krieger D7/605
D463,717 S * 10/2002 Krieger D7/605
D467,468 S * 12/2002 Krieger et al. D7/605

The broken lines immediately adjacent the shaded areas
represent the bounds of the claimed design while all other
broken lines are for illustrative purposes only; the broken
lines form no part of the claimed design.

1 Claim, 7 Drawing Sheets

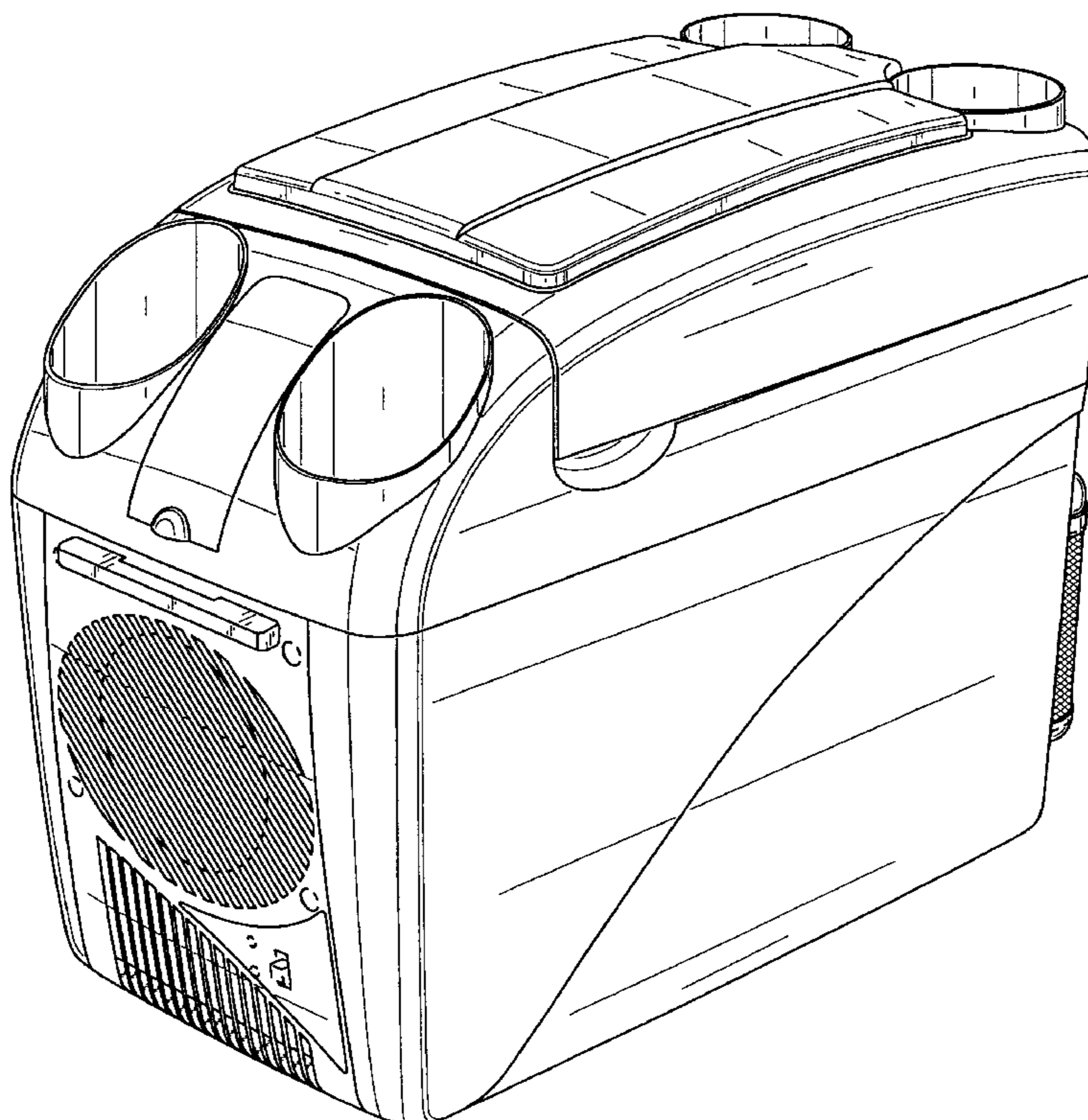

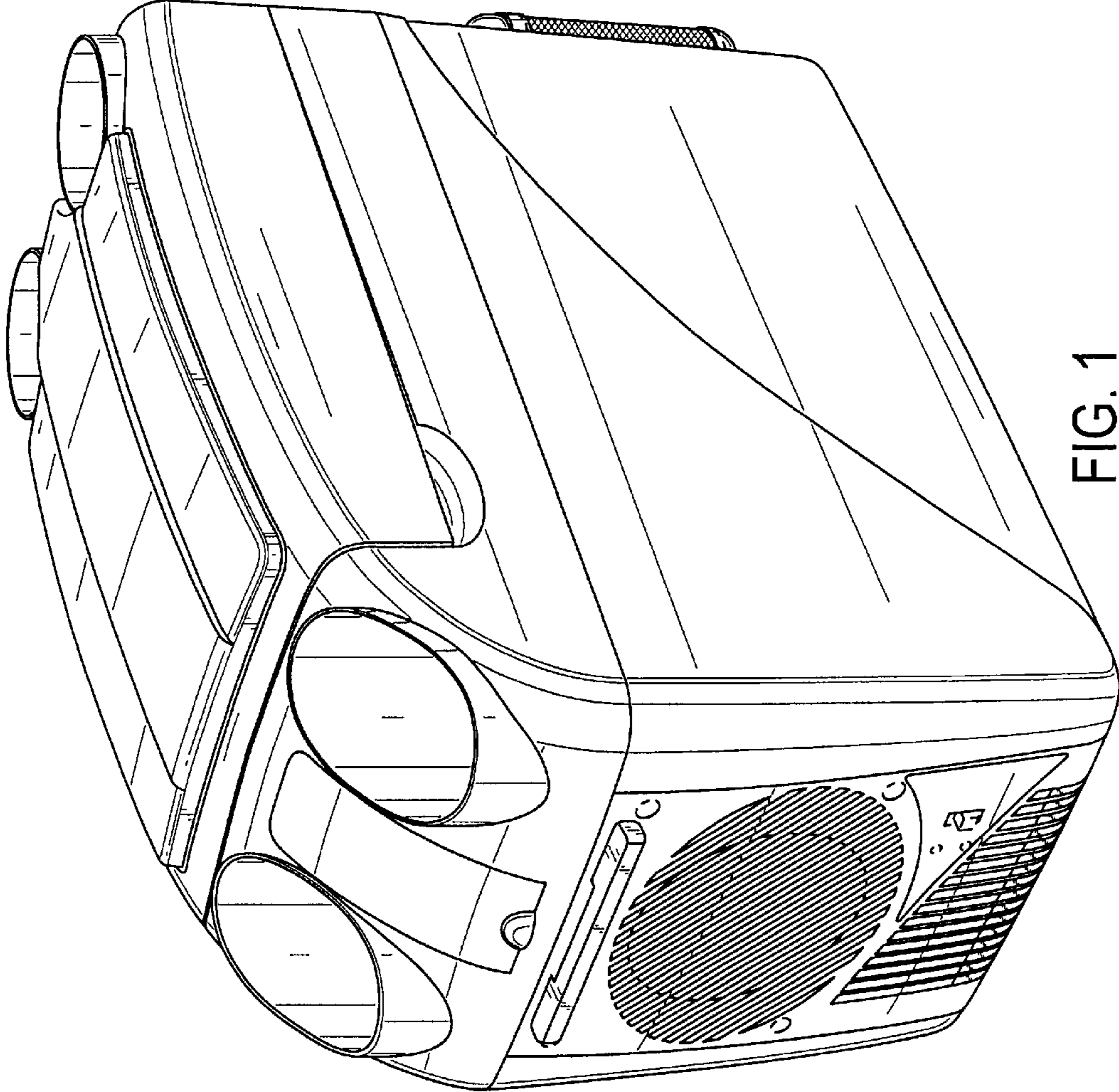

FIG. 1

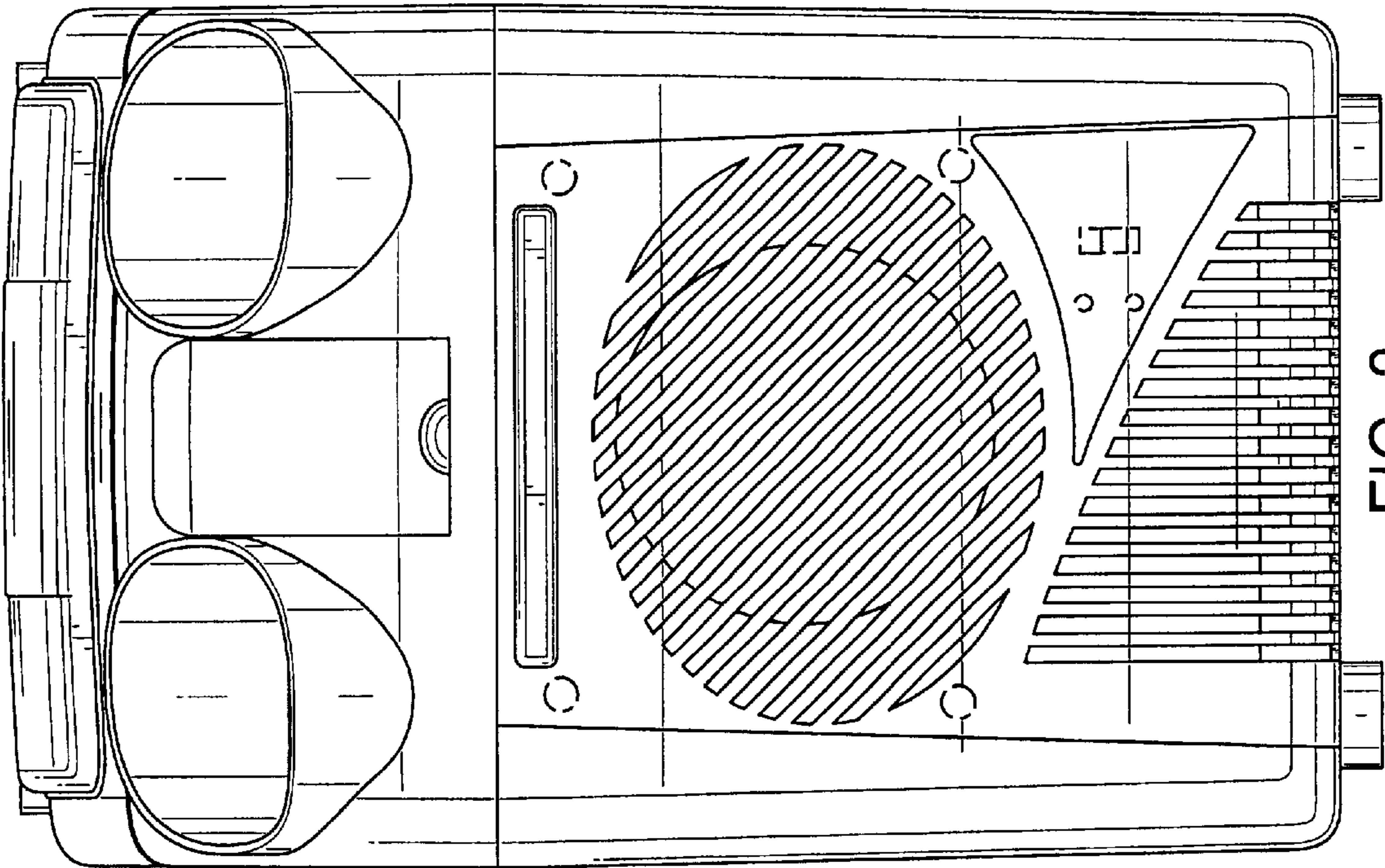

FIG. 2

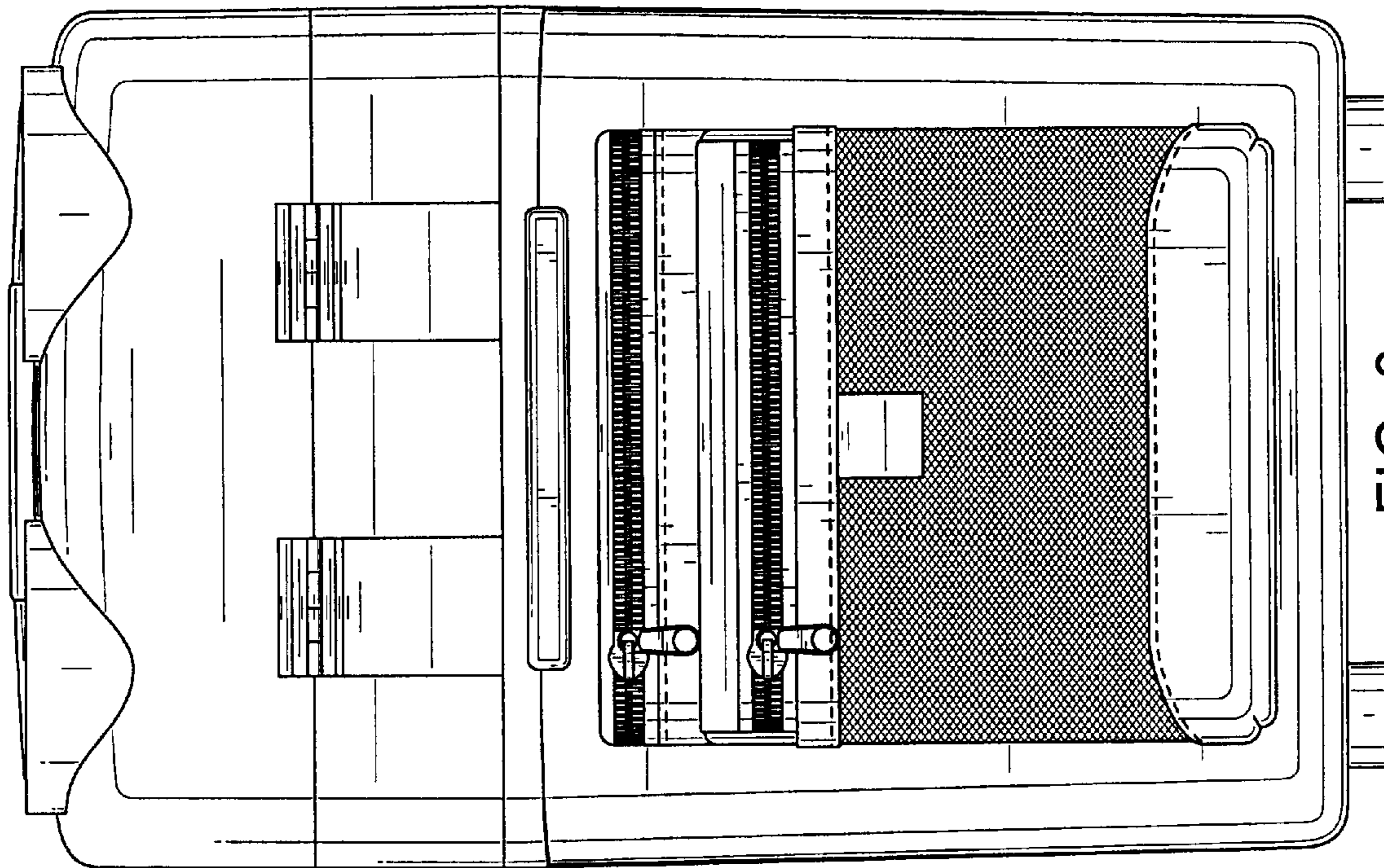

FIG. 3

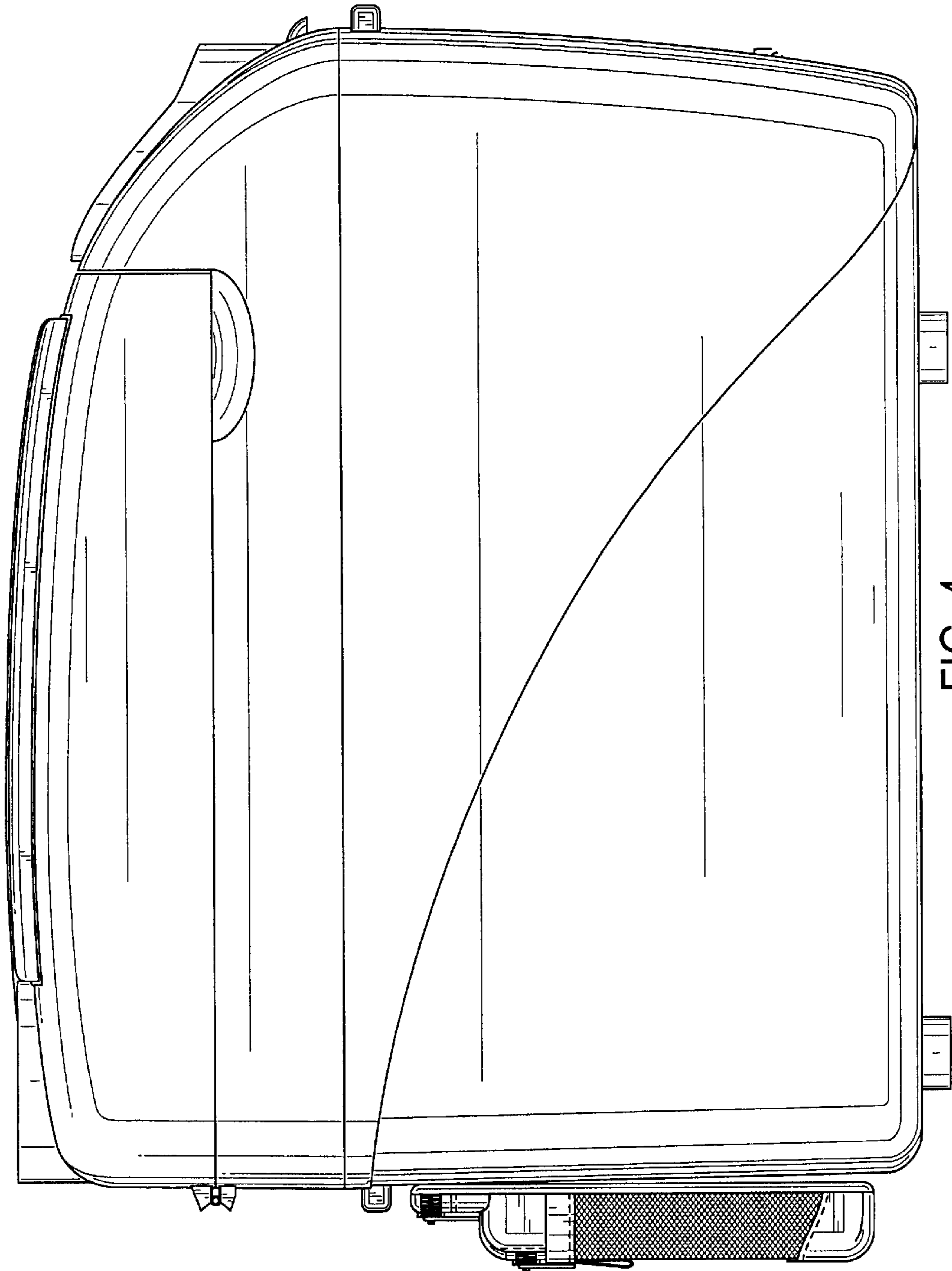

FIG. 4

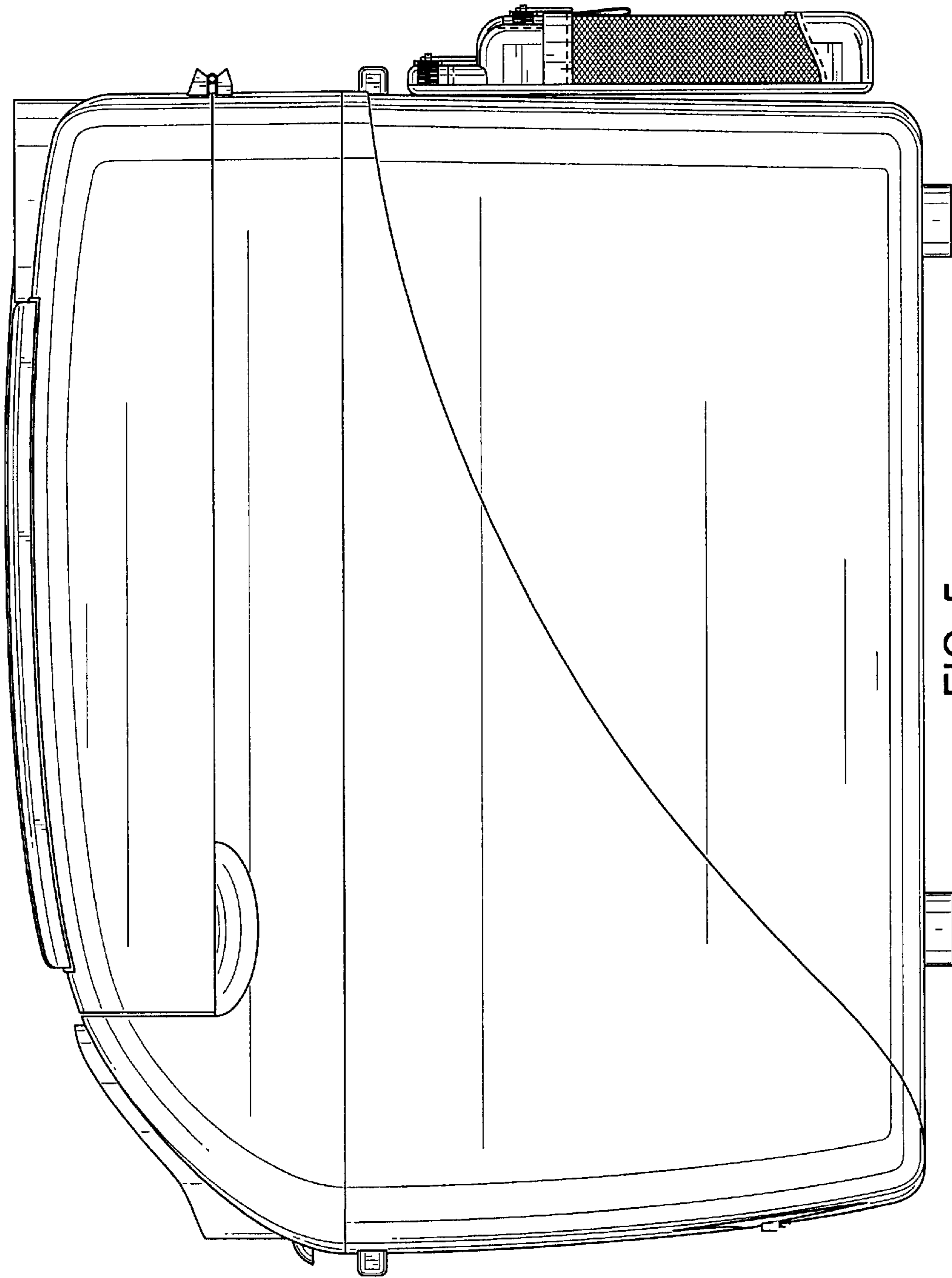

FIG. 5

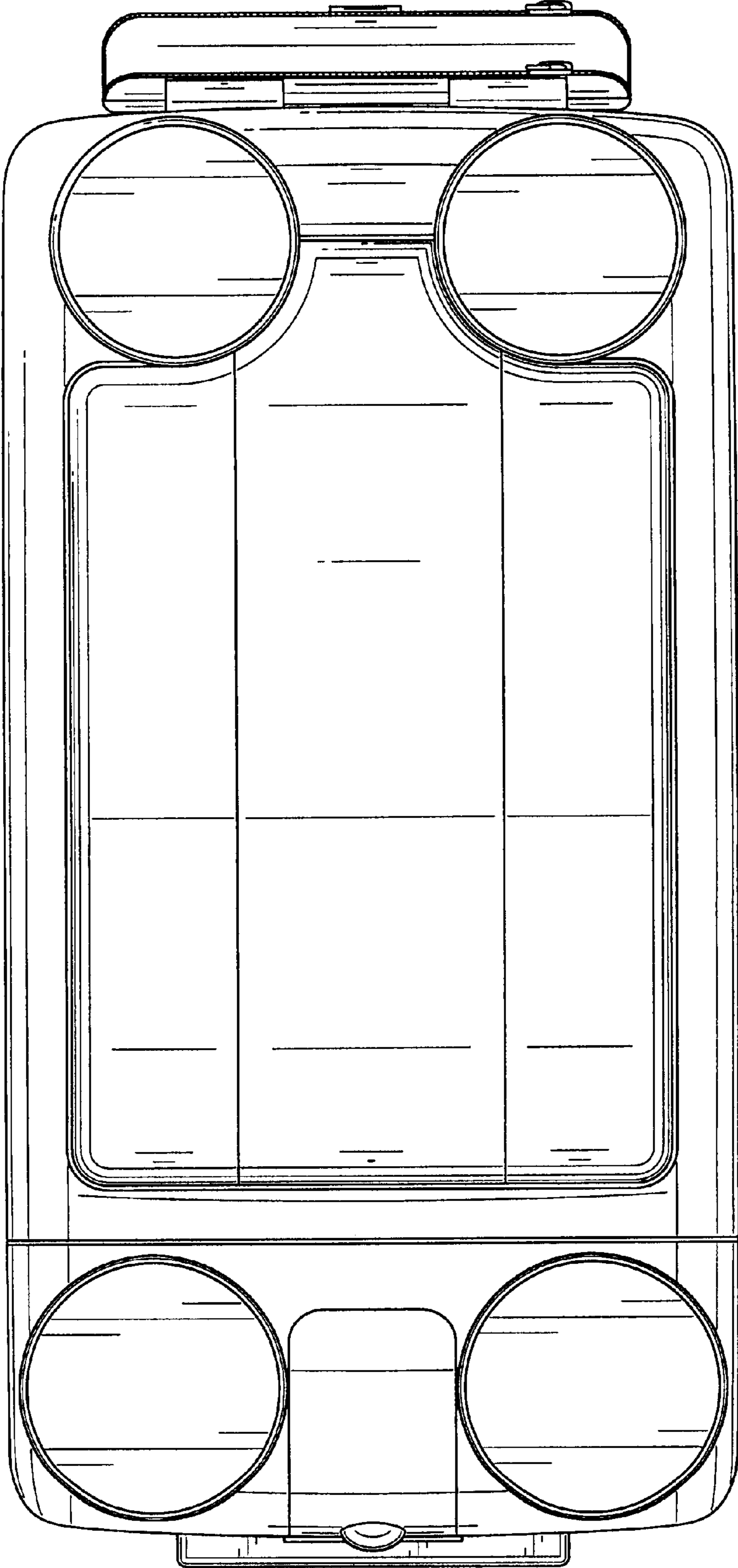

FIG. 6

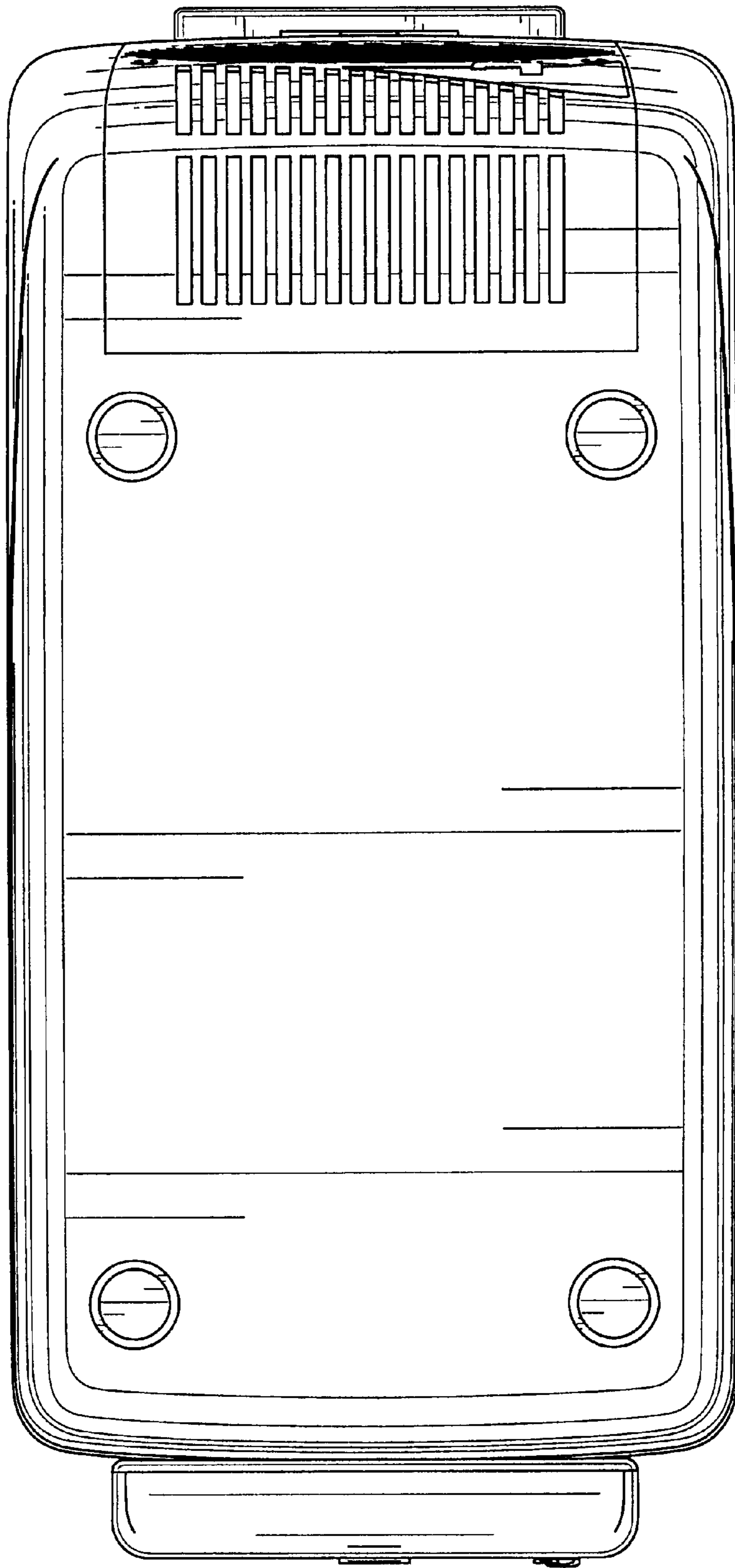

FIG. 7