

US00D525050S

(12) **United States Design Patent**
Bruce

(10) **Patent No.:** **US D525,050 S**

(45) **Date of Patent:** **** Jul. 18, 2006**

(54) **VANITY CABINET**

(75) Inventor: **David Bruce**, Monroe Township, NJ
(US)

(73) Assignee: **Foremost Groups, Inc.**, East Hanover,
NJ (US)

(**) Term: **14 Years**

(21) Appl. No.: **29/227,082**

(22) Filed: **Apr. 6, 2005**

(51) **LOC (8) Cl.** **06-04**

(52) **U.S. Cl.** **D6/446; D23/286**

(58) **Field of Classification Search** D6/434,
D6/436-447, 470; 312/114, 204, 224, 227;
D23/286, 308

See application file for complete search history.

(56) **References Cited**

U.S. PATENT DOCUMENTS

D367,317 S	*	2/1996	Liu	D23/286
D367,318 S	*	2/1996	Liu	D23/286
D454,262 S	*	3/2002	Chu et al.	D6/446
D465,943 S	*	11/2002	Prater et al.	D6/446

* cited by examiner

Primary Examiner—Cathron C. Brooks

(74) *Attorney, Agent, or Firm*—Drinker Biddle & Reath
LLP

(57) **CLAIM**

The ornamental design for a vanity cabinet, as shown and
described.

DESCRIPTION

FIG. 1 is front elevation view of the vanity cabinet showing
my new design.

FIG. 2 is a rear elevation view of the vanity cabinet of FIG.
1.

FIG. 3 is a right side elevation view of the vanity cabinet of
FIG. 1, the left side elevation view being a mirror-image.

FIG. 4 is a top plan view of the vanity cabinet of FIG. 1.

FIG. 5 is a bottom plan view of the vanity cabinet of FIG.
1; and,

FIG. 6 is a cross-sectional view of the vanity cabinet taken
along lines 6—6 in FIG. 1.

The broken lines shown on the interior border of the claimed
portion of the design in FIG. 6 represent the bounds of the
claimed design, and all other broken lines are for illustrative
purposes only. None of the broken lines form a part of the
claimed design.

1 Claim, 4 Drawing Sheets

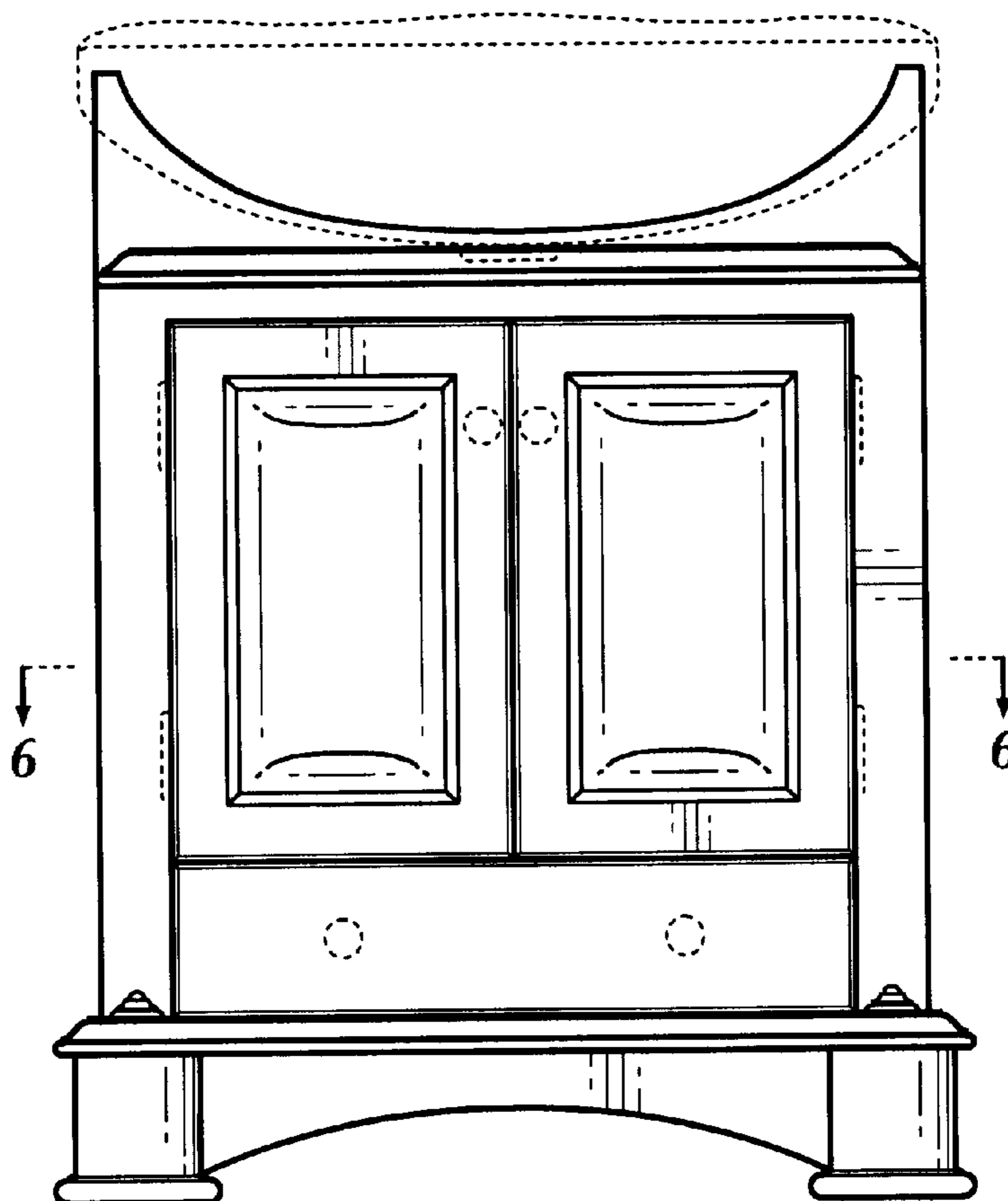

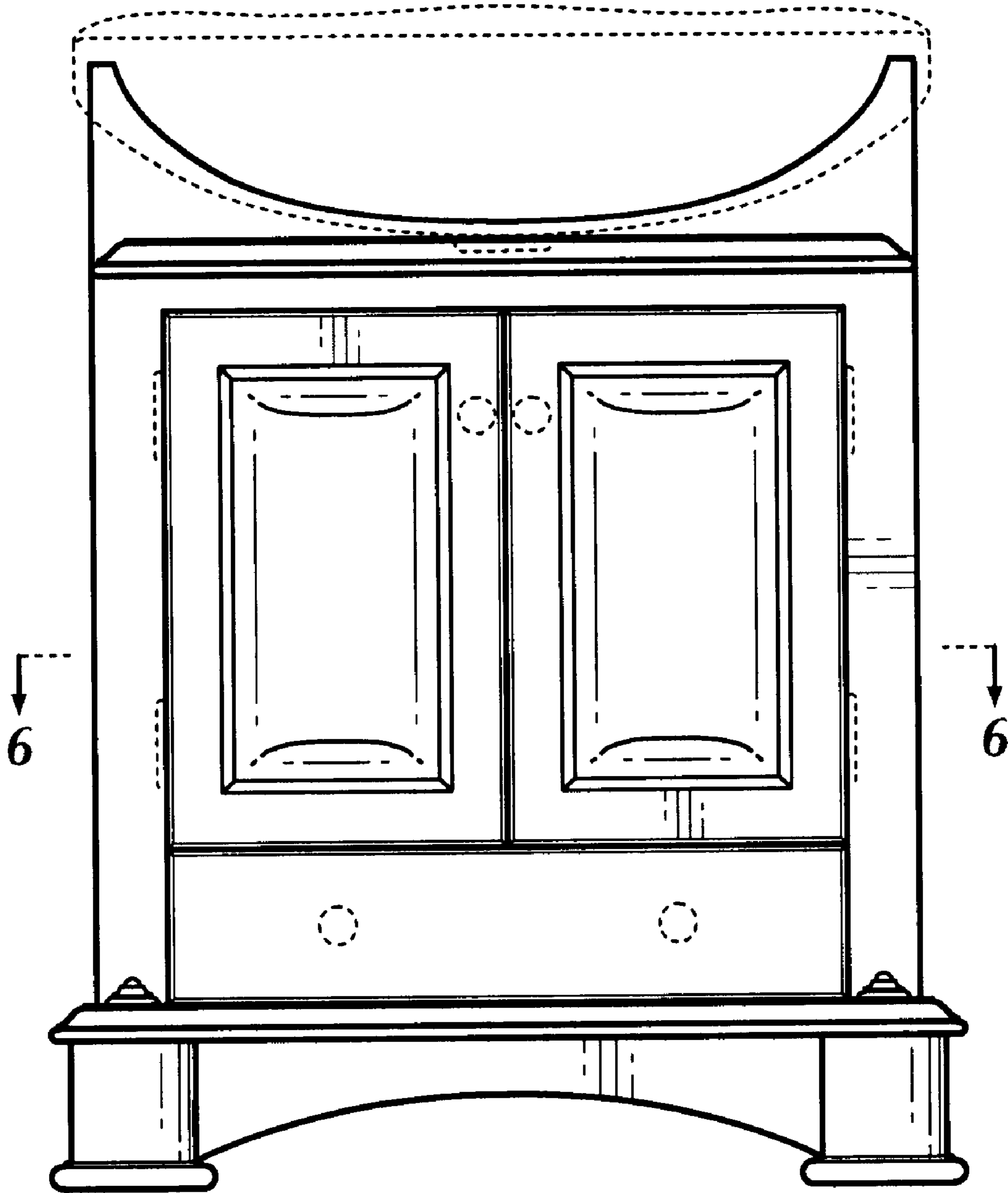

FIG. 1

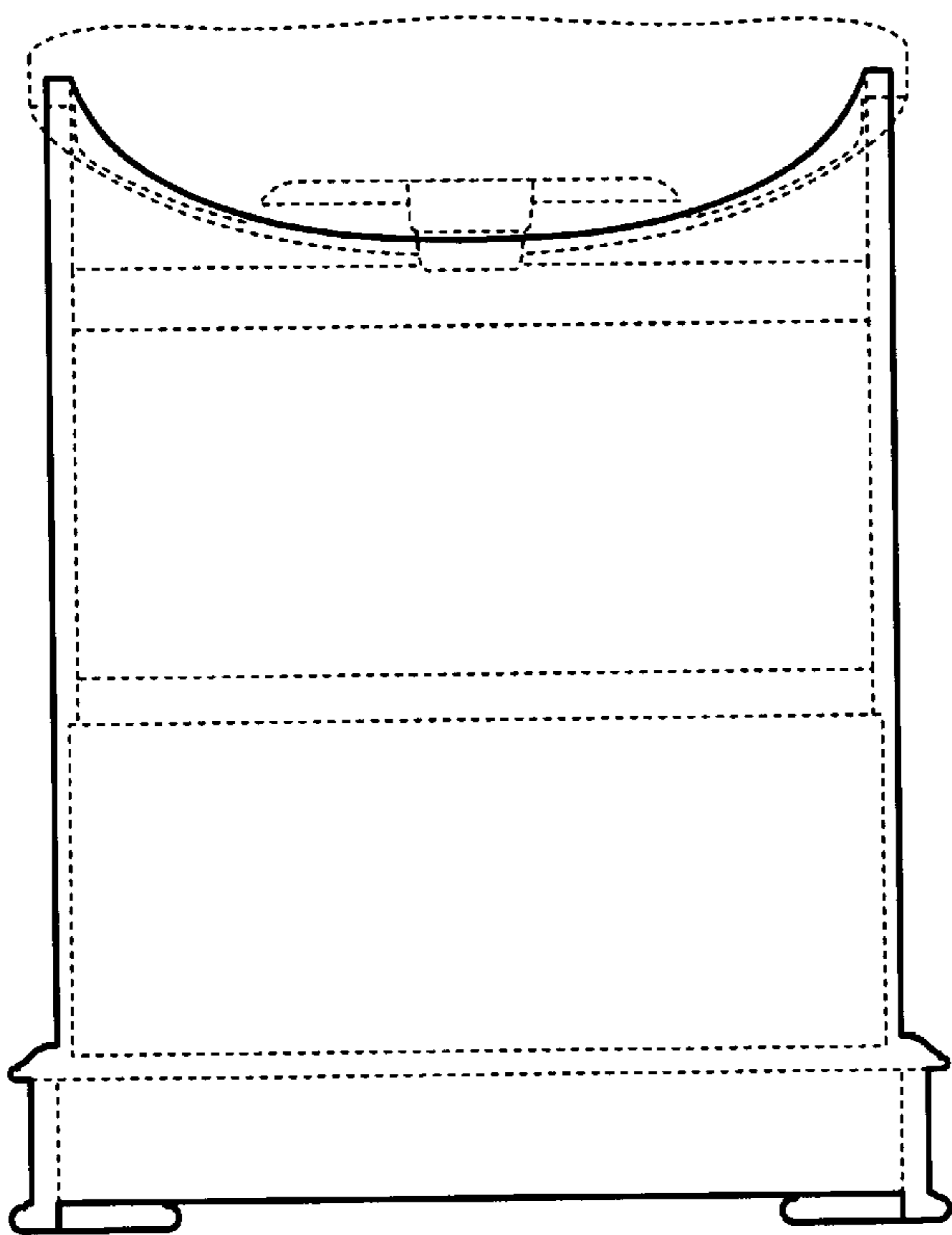

FIG. 2

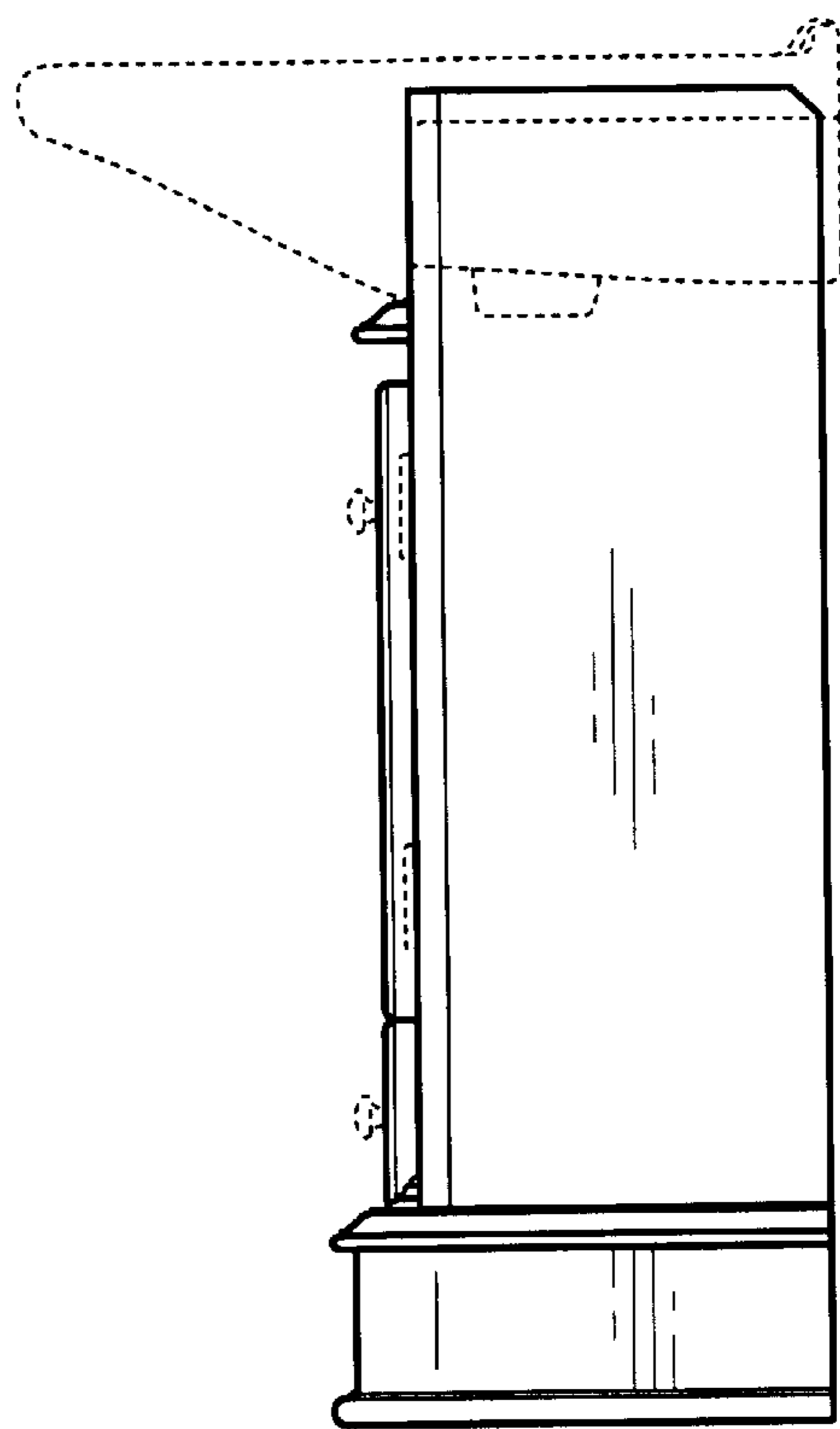

FIG. 3

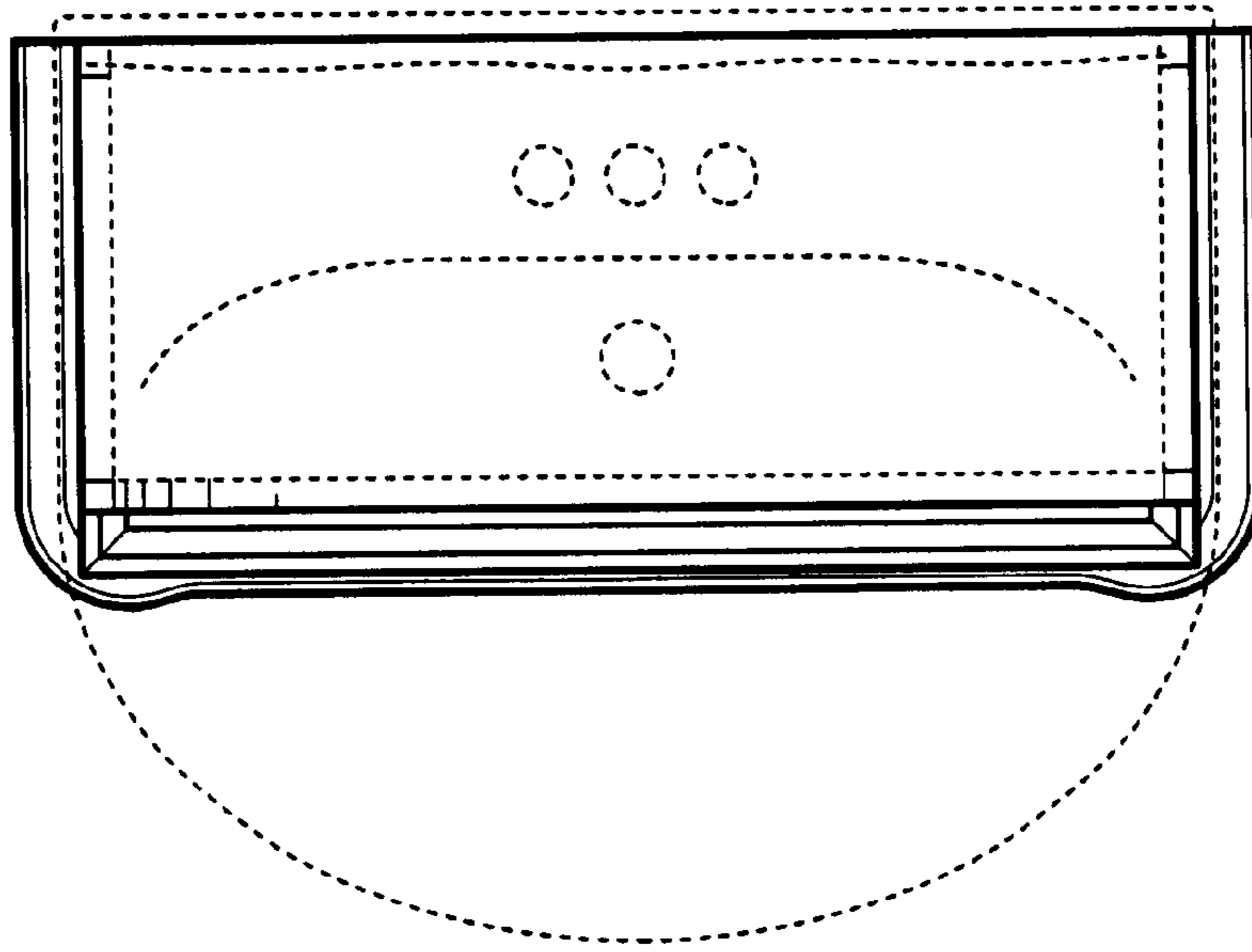

FIG. 4

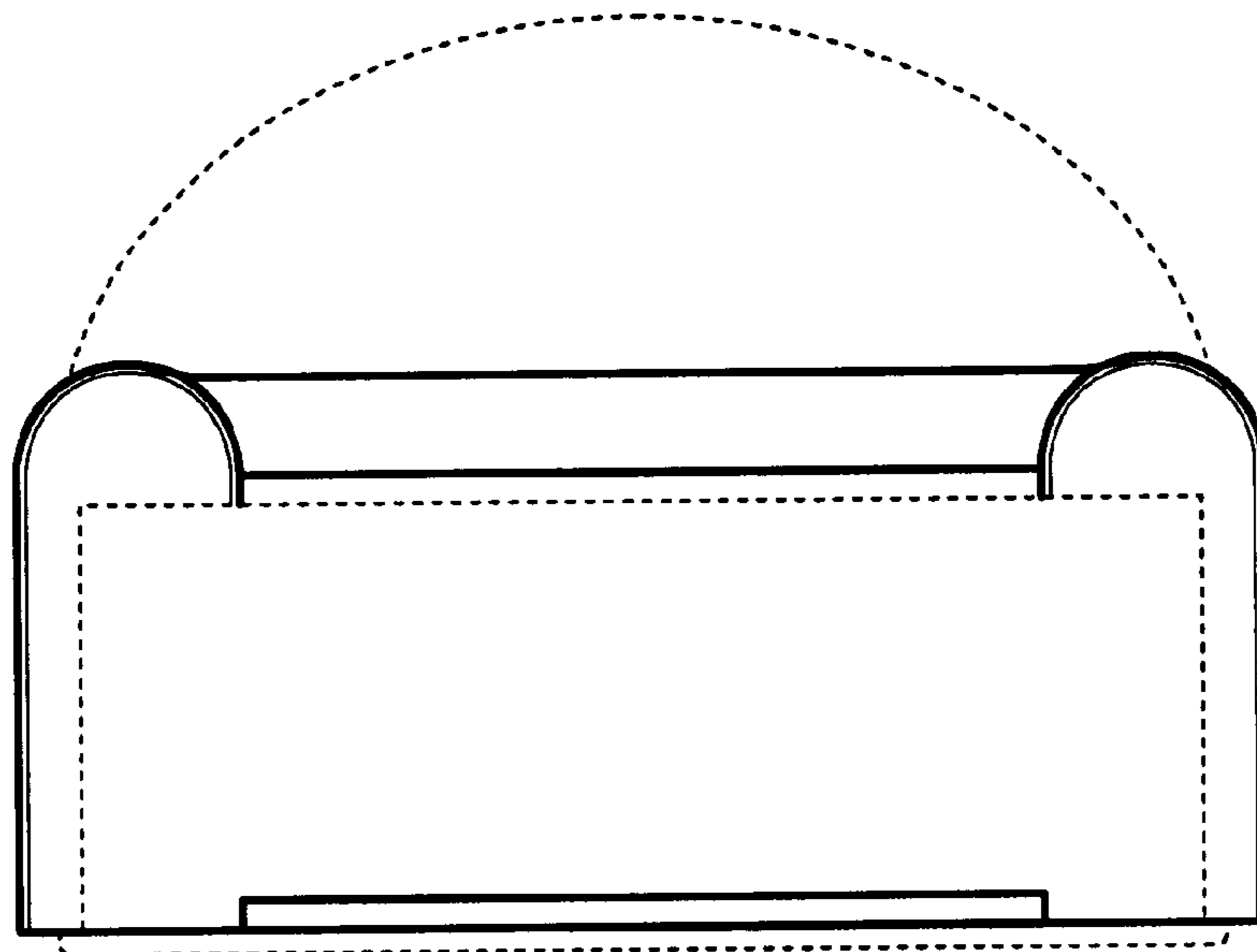

FIG. 5

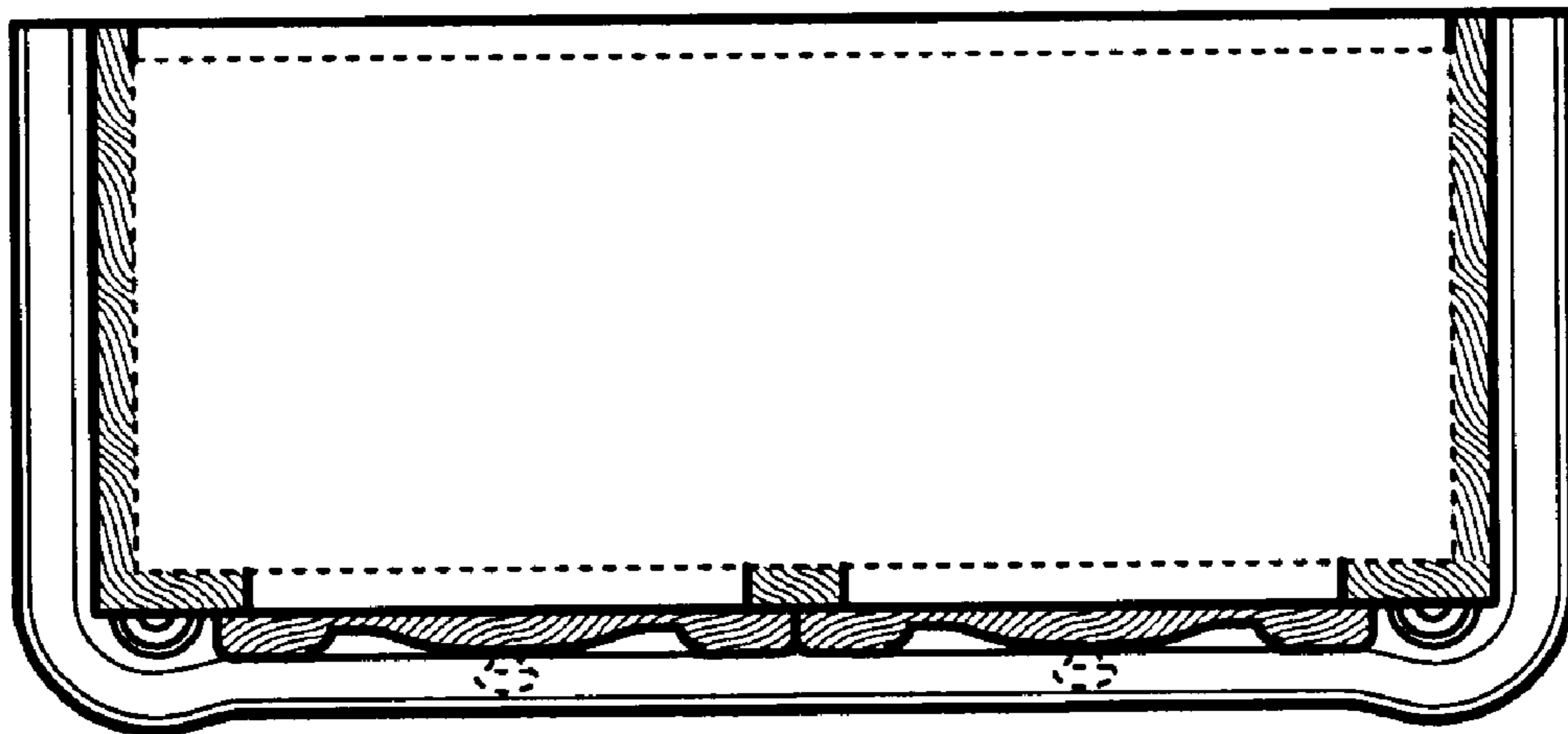

FIG. 6