



US00D525030S

(12) **United States Design Patent**
Farmer

(10) **Patent No.:** **US D525,030 S**

(45) **Date of Patent:** **** Jul. 18, 2006**

(54) **JEWELRY BOOK**

(76) Inventor: **Valerie J. Farmer**, 443 Lawrence Ave.,
Marseilles, IL (US) 61341

(**) Term: **14 Years**

(21) Appl. No.: **29/217,209**

(22) Filed: **Nov. 15, 2004**

(51) **LOC (8) Cl.** **03-01**

(52) **U.S. Cl.** **D3/271.5; D3/271.1; D3/903**

(58) **Field of Classification Search** D3/270,
D3/271.1, 271.5, 294, 901, 903; D6/301,
D6/303; 206/6.1, 457

See application file for complete search history.

(56) **References Cited**

U.S. PATENT DOCUMENTS

1,233,605	A	*	7/1917	Ridley	206/6.1
1,445,593	A	*	2/1923	Iscowitz	206/242
1,709,685	A	*	4/1929	Rothrock	206/472
1,960,073	A	*	5/1934	Warner	206/759
2,797,806	A	*	7/1957	Davis	206/486
D186,829	S	*	12/1959	Jachetta	D3/270
D266,115	S	*	9/1982	Glenn et al.	D3/295
4,420,084	A	*	12/1983	Whelan	206/566
4,720,012	A	*	1/1988	Dufour	206/472
4,735,246	A		4/1988	Niehaus		
4,848,585	A		7/1989	Snyder		
D303,764	S	*	10/1989	Kilmartin, III	D9/423
4,930,635	A		6/1990	Hotchkiss et al.		
4,978,001	A	*	12/1990	Nelson	206/748

D317,380	S	*	6/1991	Snyder	D3/295
5,141,300	A	*	8/1992	Ciesla	312/204
D335,768	S	*	5/1993	Romo	D3/295
D348,155	S	*	6/1994	McCreary et al.	D3/295
5,588,537	A		12/1996	Hagopian		
D382,731	S	*	8/1997	Martin	D6/469
D386,677	S	*	11/1997	Abiteboul	D3/271.5
D393,542	S	*	4/1998	Thompson	D3/294
5,899,343	A		5/1999	Franklin et al.		
D436,727	S	*	1/2001	Hsu	D3/294
D444,947	S	*	7/2001	Nelson	D3/294
D468,529	S	*	1/2003	Sabounjian	D3/273

* cited by examiner

Primary Examiner—Philip S. Hyder

Assistant Examiner—RoseLynne Ulm

(74) *Attorney, Agent, or Firm*—Theresa M. Seal

(57) **CLAIM**

The ornamental design for the jewelry book, as shown and described.

DESCRIPTION

FIG. 1 is a perspective view of an open jewelry book illustrating rings and earrings secured thereof; FIG. 2 is a perspective view of an open jewelry book thereof; FIG. 3 is an elevational left side view thereof; FIG. 4 is an elevational right side view thereof; FIG. 5 is an elevational back view thereof; FIG. 6 is an elevational front view thereof; FIG. 7 is an elevational top view thereof; and, FIG. 8 is an elevational bottom view thereof.

1 Claim, 5 Drawing Sheets

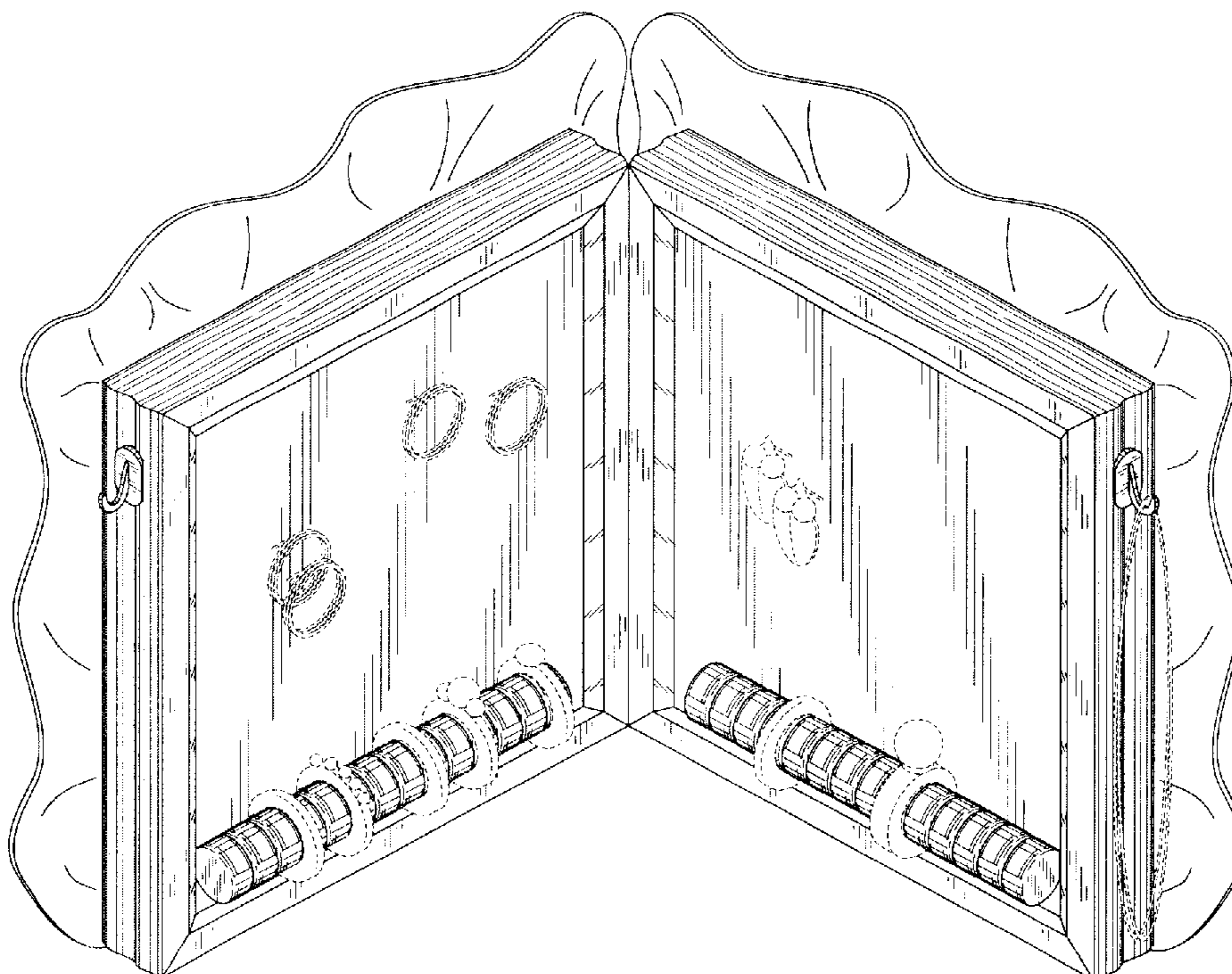

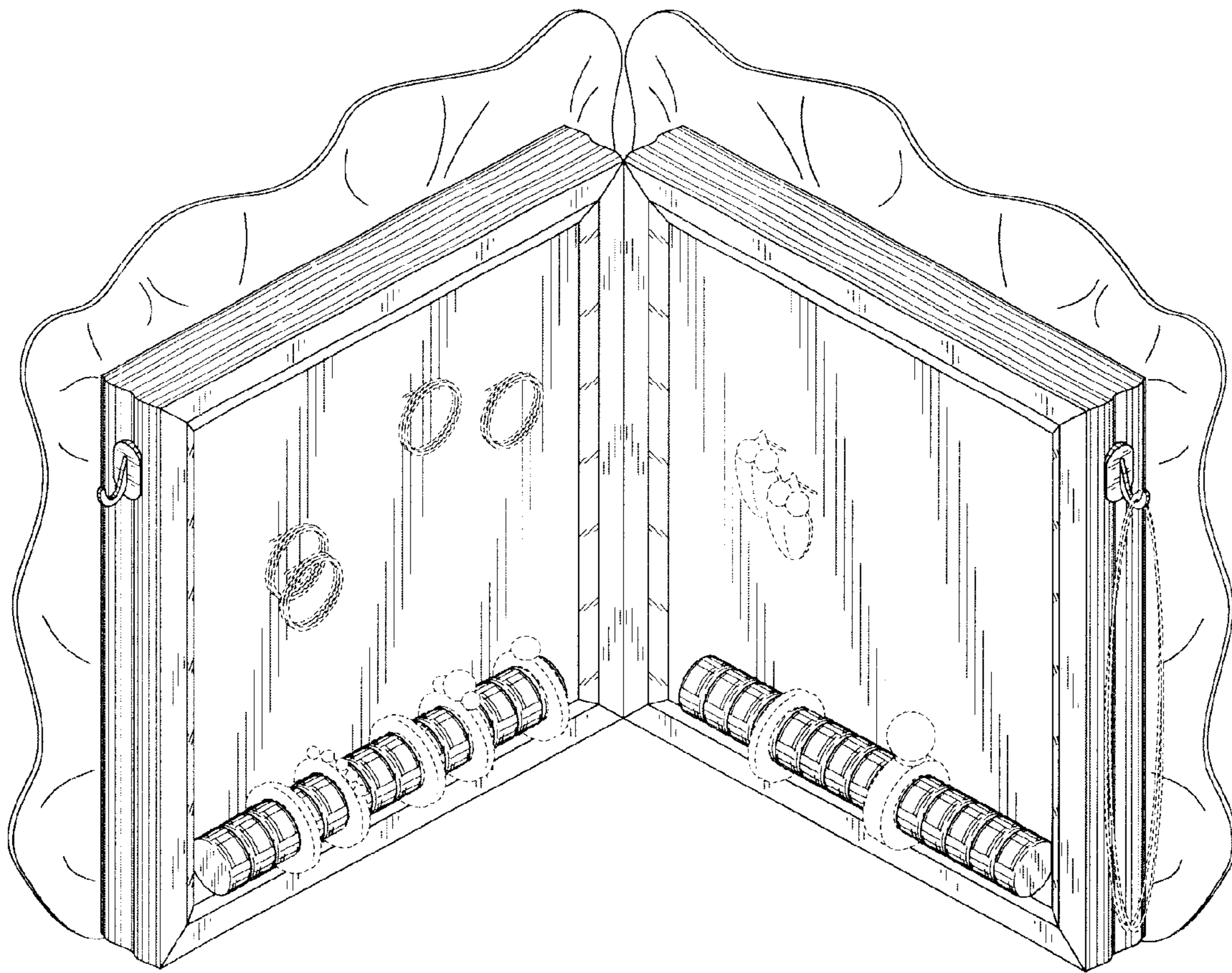

Fig. 1

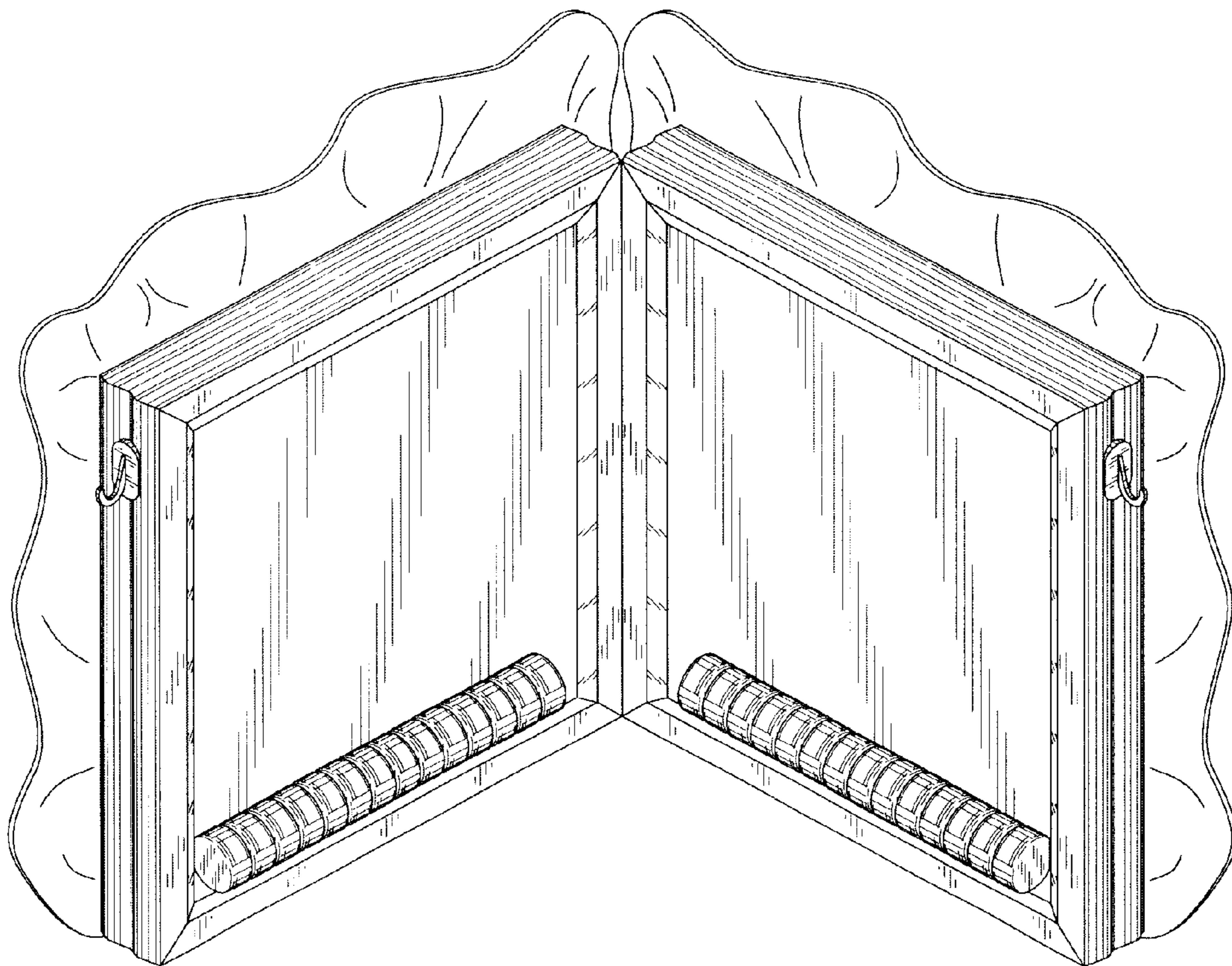

Fig. 2

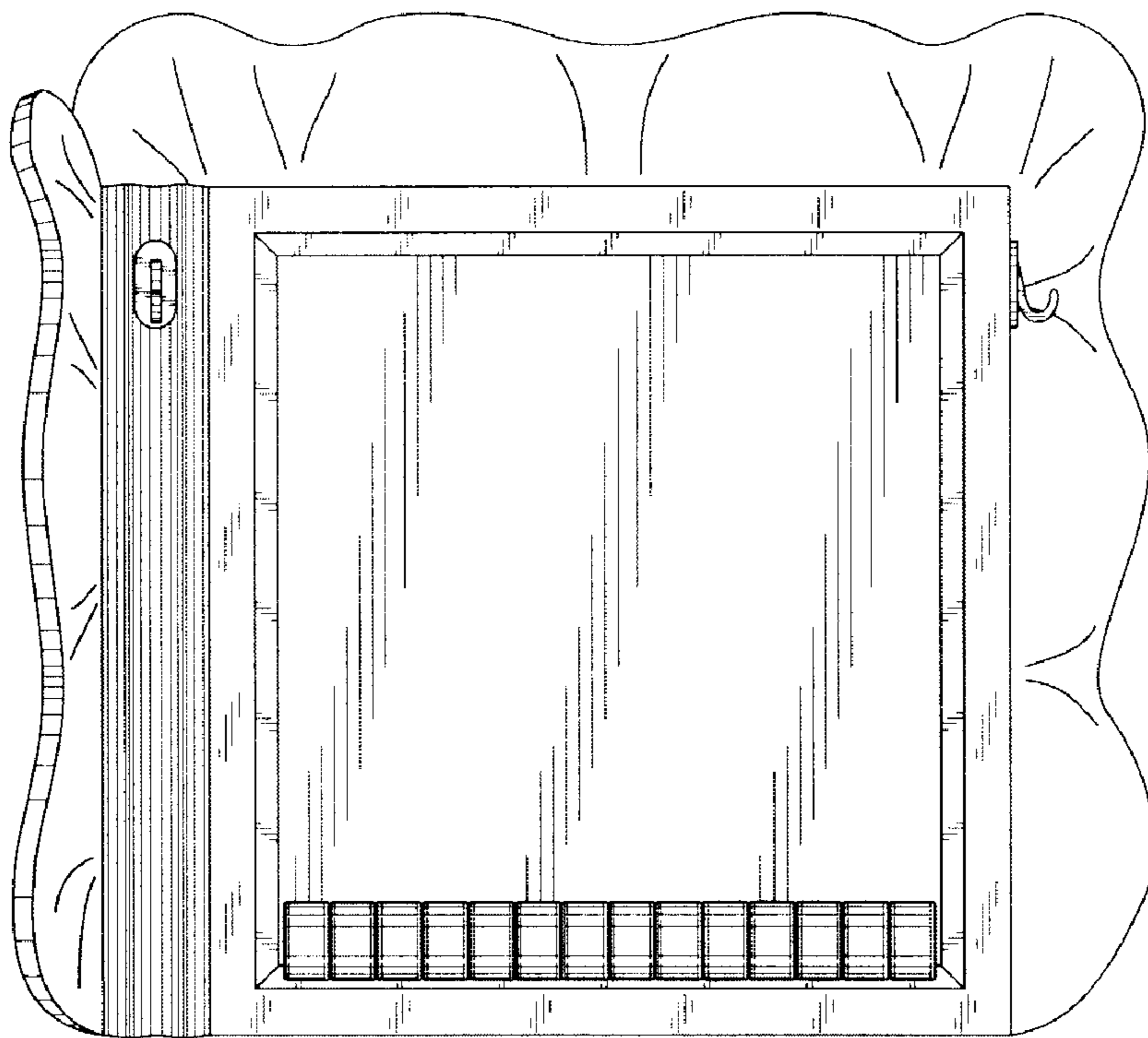

Fig. 3

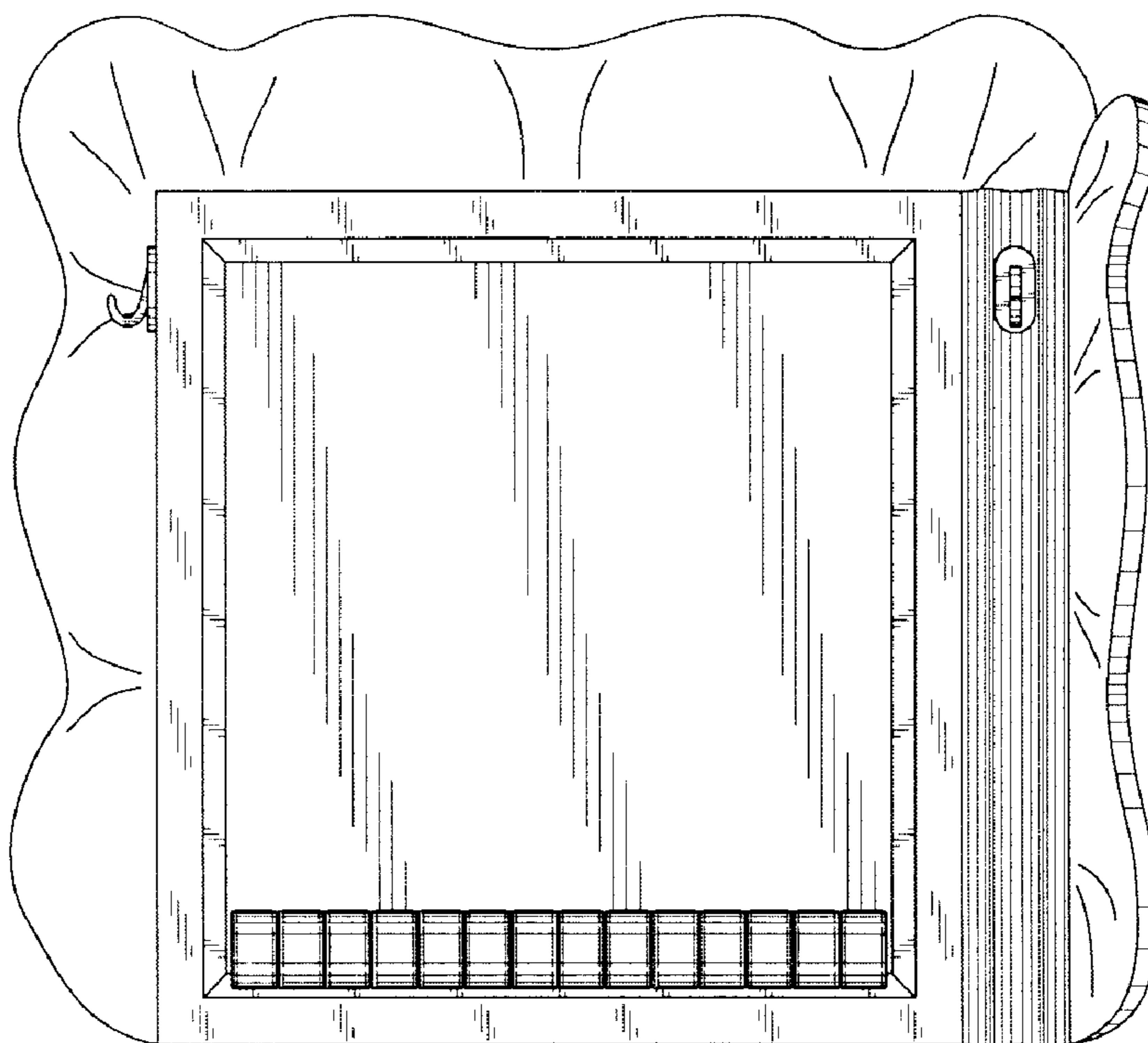

Fig. 4

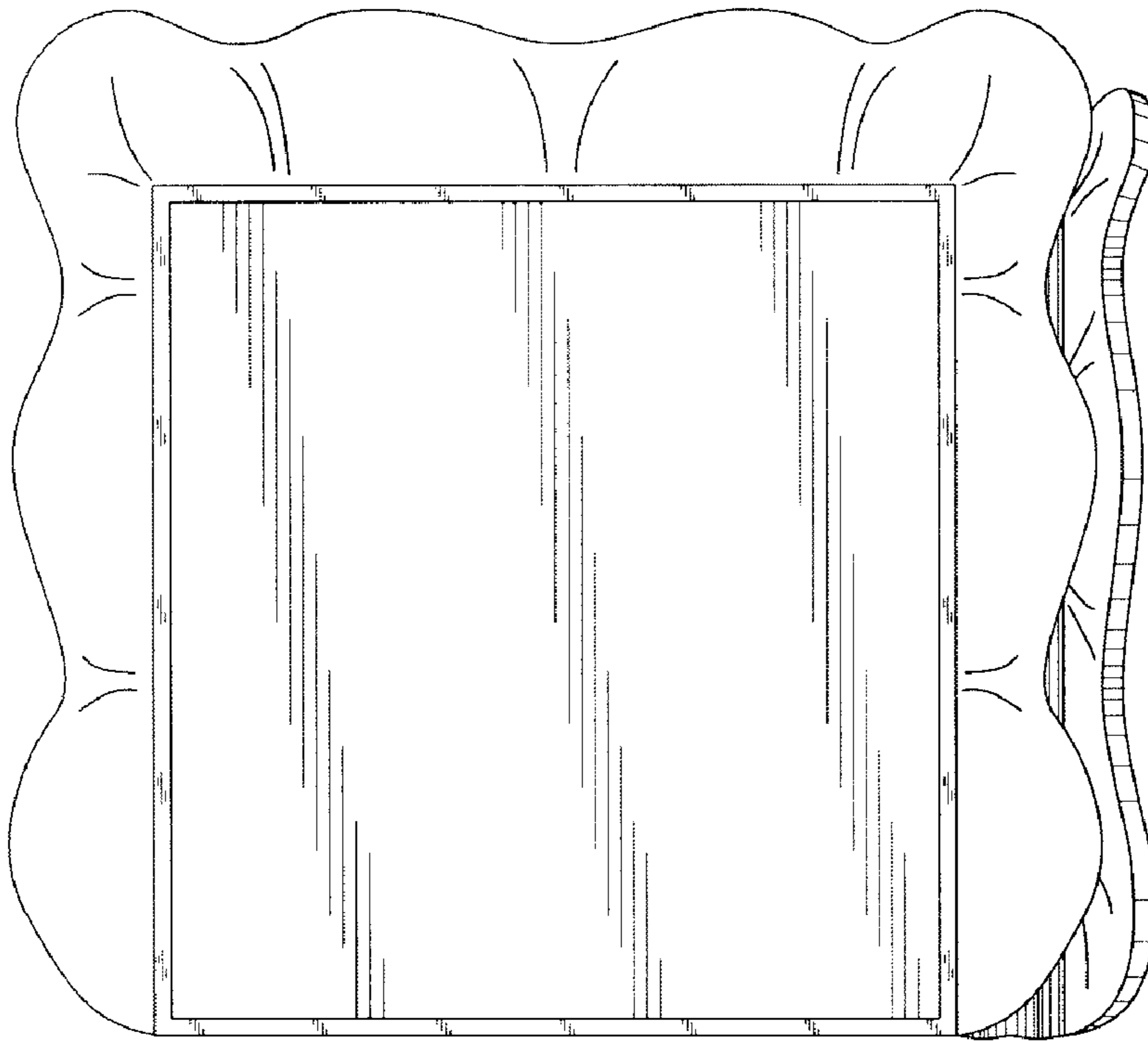

Fig. 5

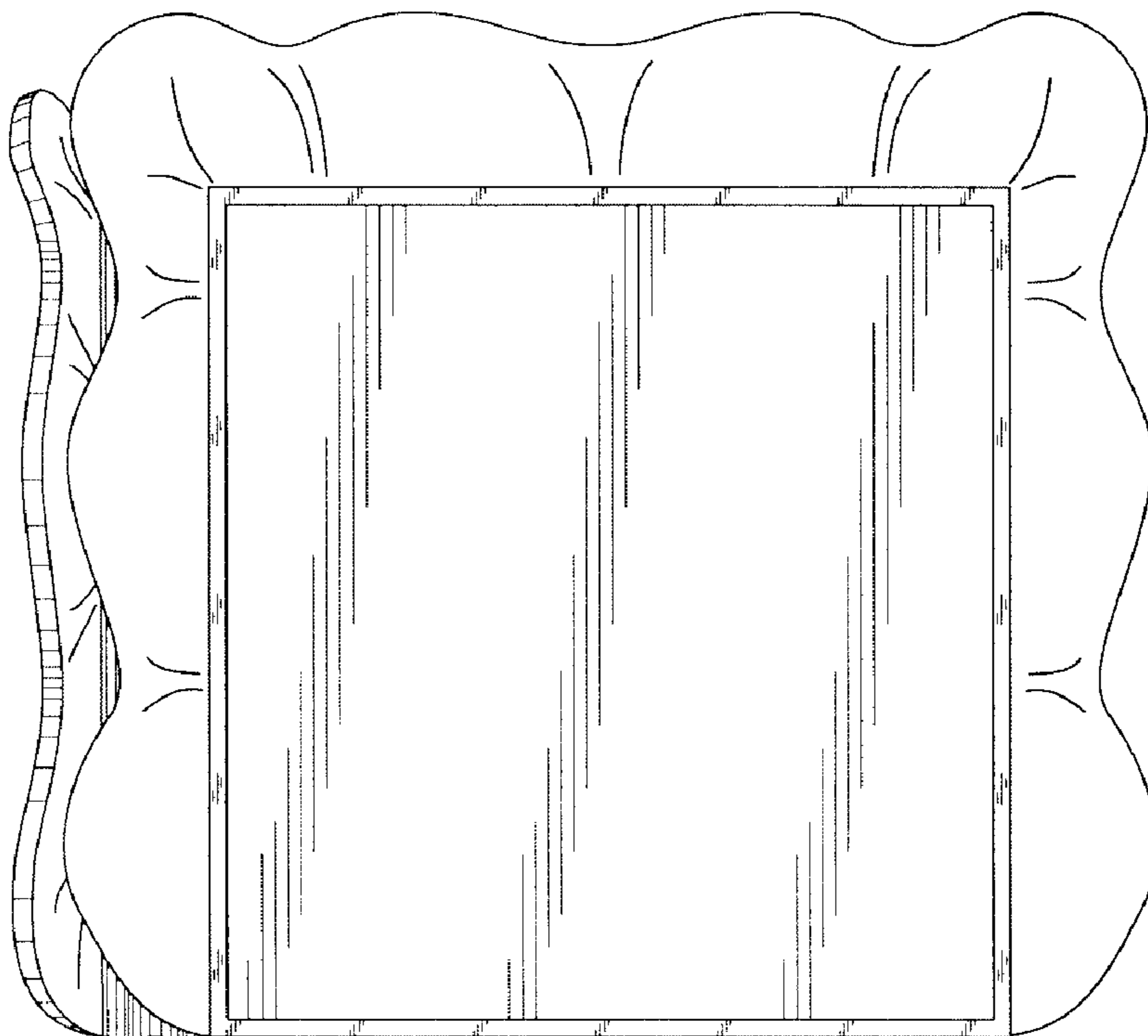

Fig. 6

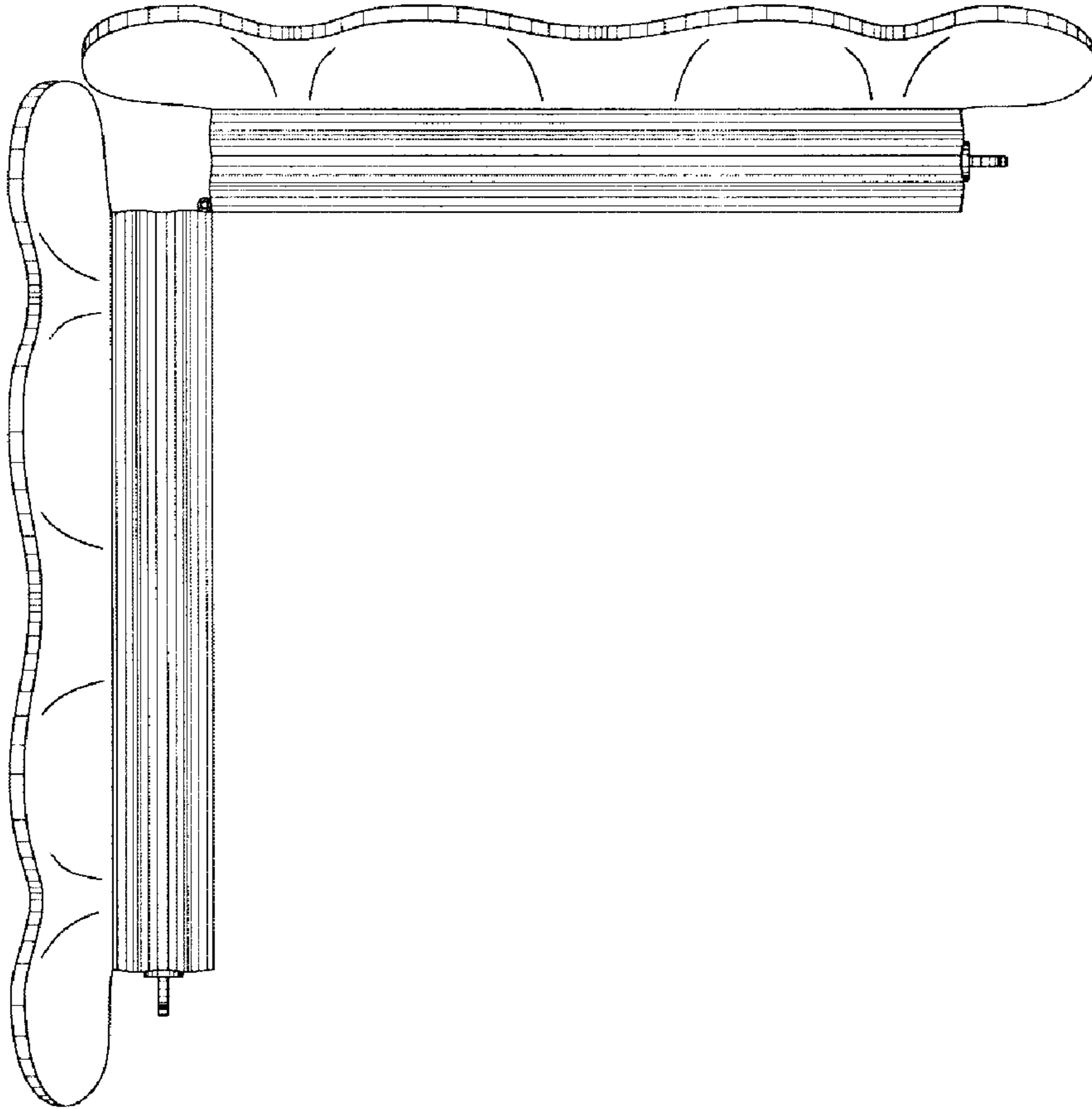

Fig. 7

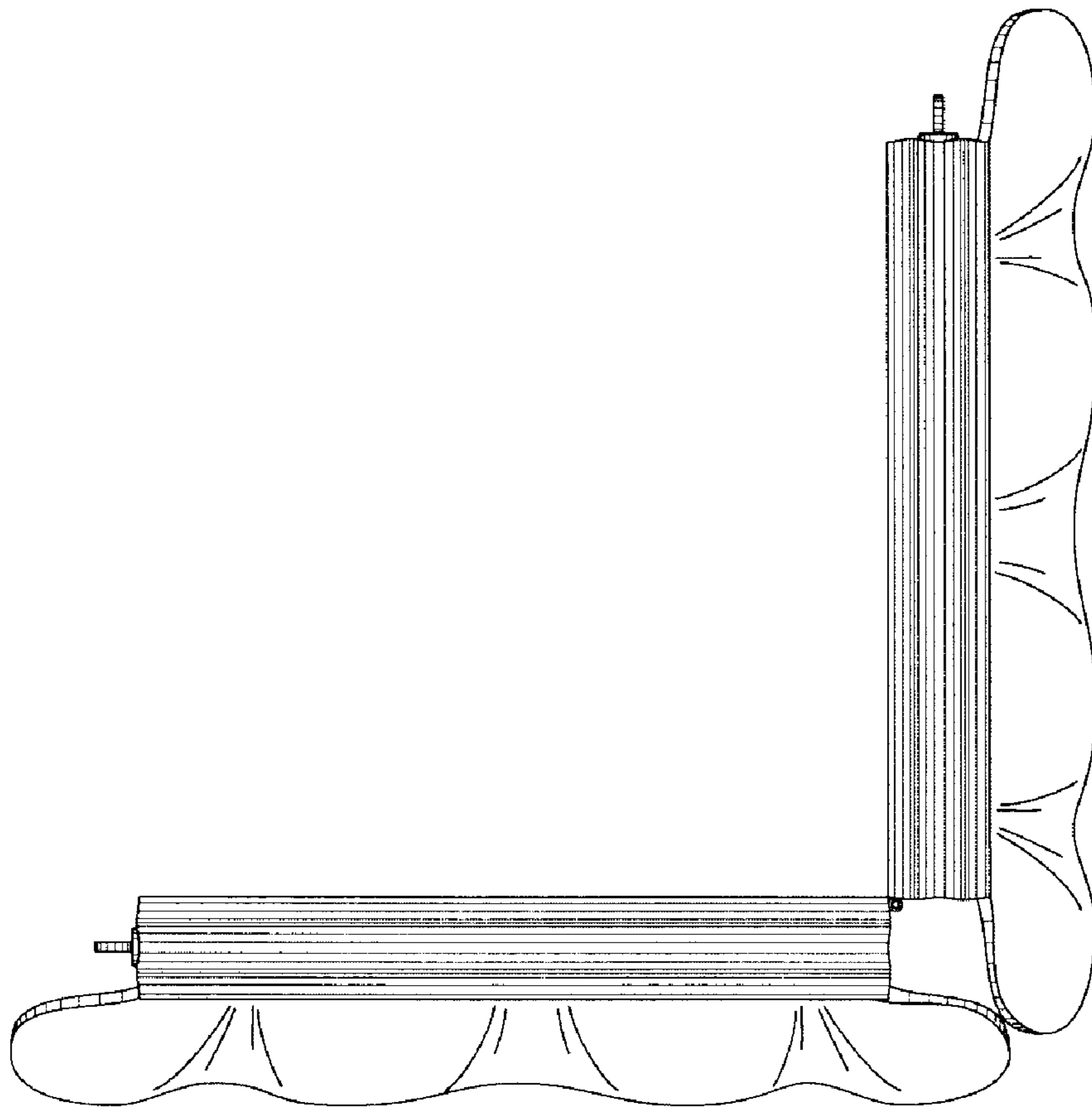

Fig. 8