



US00D525024S

(12) **United States Design Patent**
Fridie et al.

(10) **Patent No.:** **US D525,024 S**
(45) **Date of Patent:** **** Jul. 18, 2006**

(54) **ELECTRONIC TOLL PASS COVER**

(75) Inventors: **Ly John Terlandon Fridie**, Moun
Laurel, NJ (US); **Karim Abdullah**,
Sicklerville, NJ (US)

(73) Assignee: **Ezcovers Inc.**, Mount Laurel, NJ (US)

(**) Term: **14 Years**

(21) Appl. No.: **29/204,098**

(22) Filed: **Apr. 26, 2004**

(51) **LOC (8) Cl.** **03-01**

(52) **U.S. Cl.** **D3/201; D3/247**

(58) **Field of Classification Search** D3/201,
D3/247, 248, 249, 250, 251, 252, 263; 150/129,
150/131, 132, 133, 135, 138, 140, 145, 147,
150/901; 190/124, 125, 126, 127, 903; 383/907;
D19/1, 90; 40/1.5, 1.6, 586, 587, 564.01,
40/663; 116/200, 321; 206/37, 38, 39, 39.5,
206/39.6, 39.7, 805; 229/67.1, 67.2, 72; 224/182,
224/219, 220, 221, 227, 236, 660, 623; 340/568.1,
340/568.7

See application file for complete search history.

(56) **References Cited**

U.S. PATENT DOCUMENTS

1,470,709 A * 10/1923 Cook 150/147

1,839,758 A * 1/1932 Hasek 150/132
D161,422 S * 1/1951 Chase D3/251
4,645,077 A * 2/1987 McLaughlin et al. 206/37
5,230,627 A * 7/1993 Todd 150/135
D352,172 S * 11/1994 Aversa et al. D3/247

* cited by examiner

Primary Examiner—Ian Simmons
Assistant Examiner—Melanie Levy

(57) **CLAIM**

The ornamental design for an electronic toll pass cover, as shown and described.

DESCRIPTION

FIG. 1 is a front perspective view of an electronic toll pass cover showing my new design;

FIG. 2 is a front view thereof;

FIG. 3 is a front perspective view in an open position thereof;

FIG. 4 is a rear perspective view thereof;

FIG. 5 is a rear view thereof; and,

FIG. 6 is a right side view thereof.

1 Claim, 6 Drawing Sheets

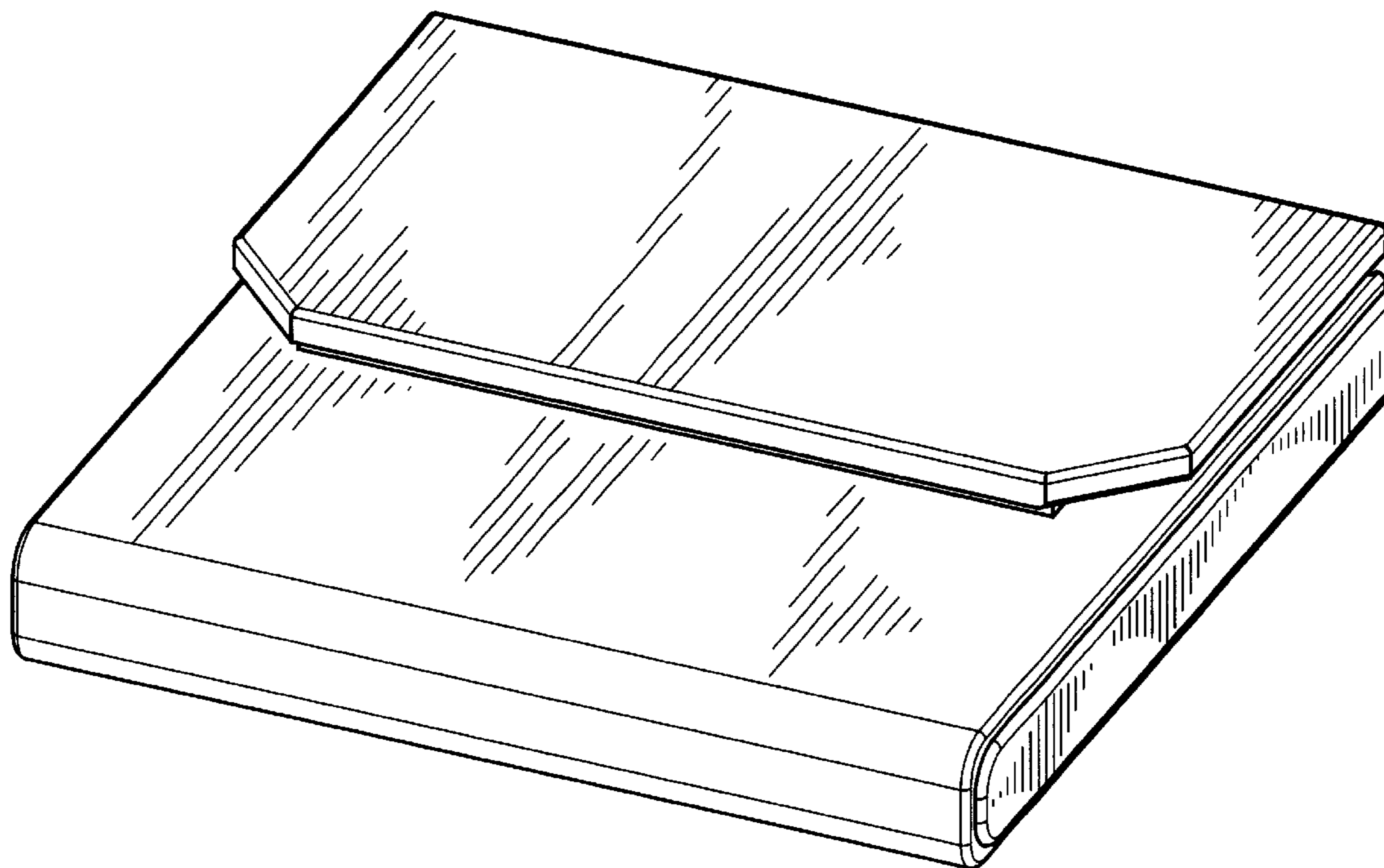

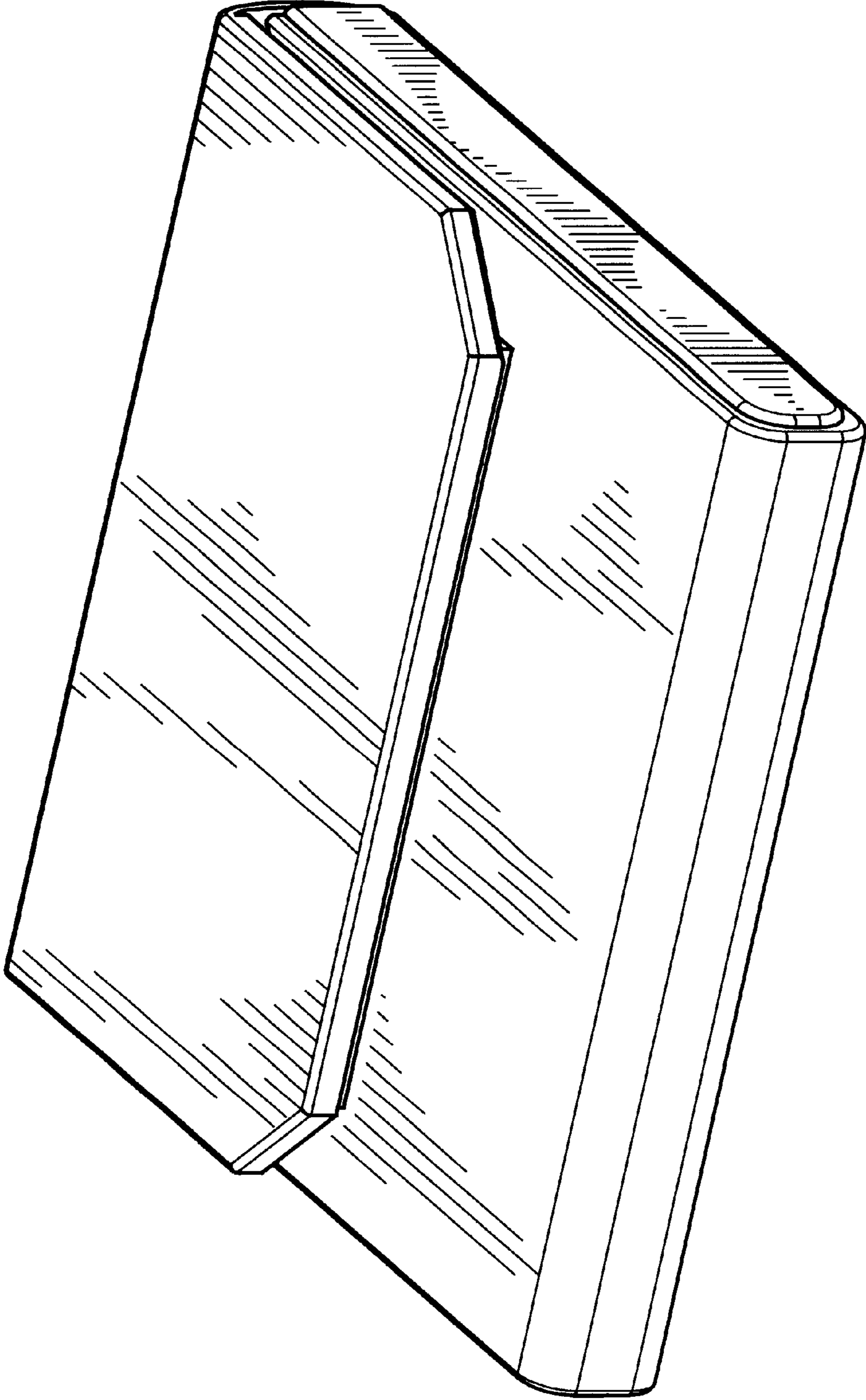

Fig. 1

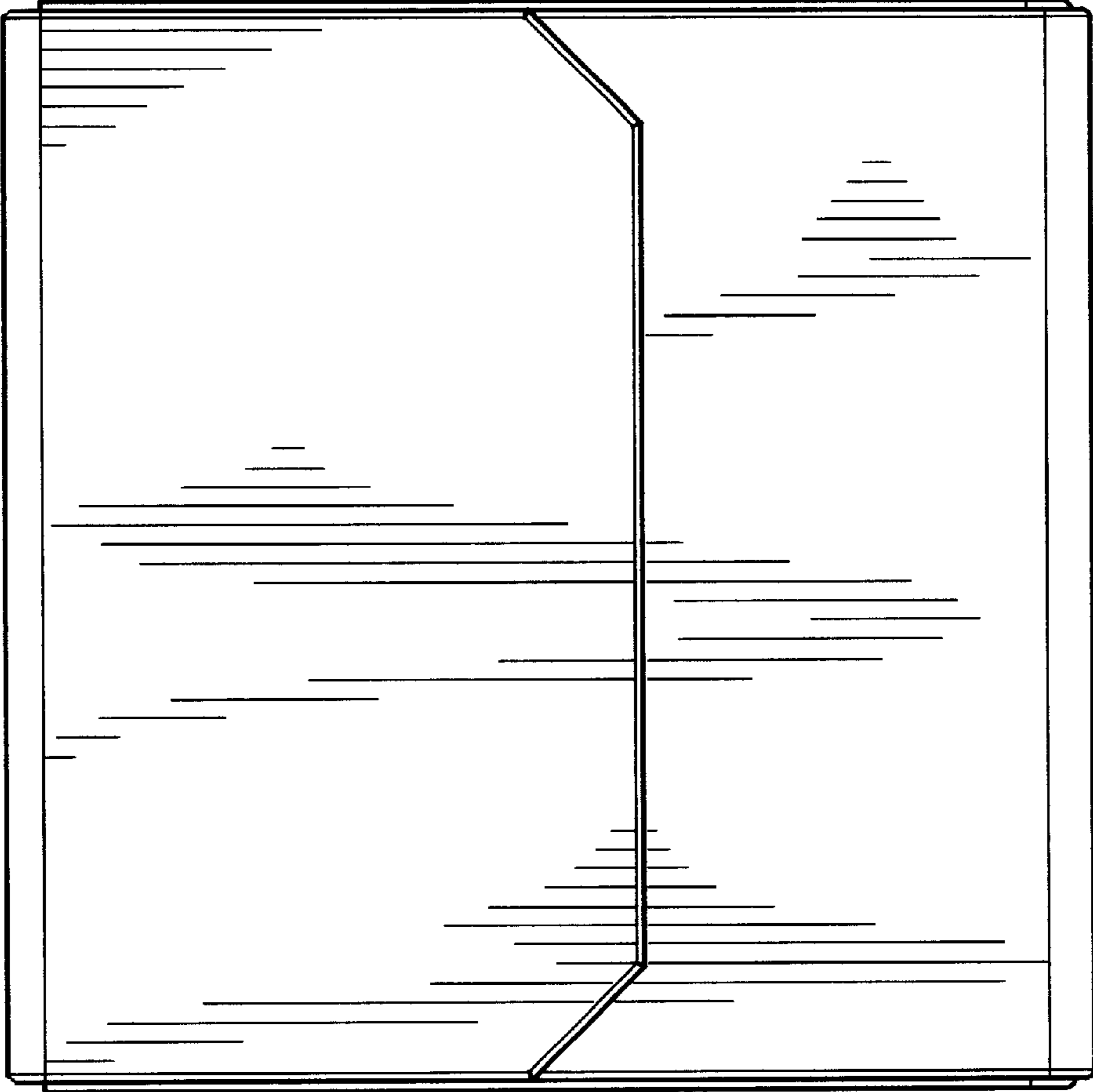

Fig. 2

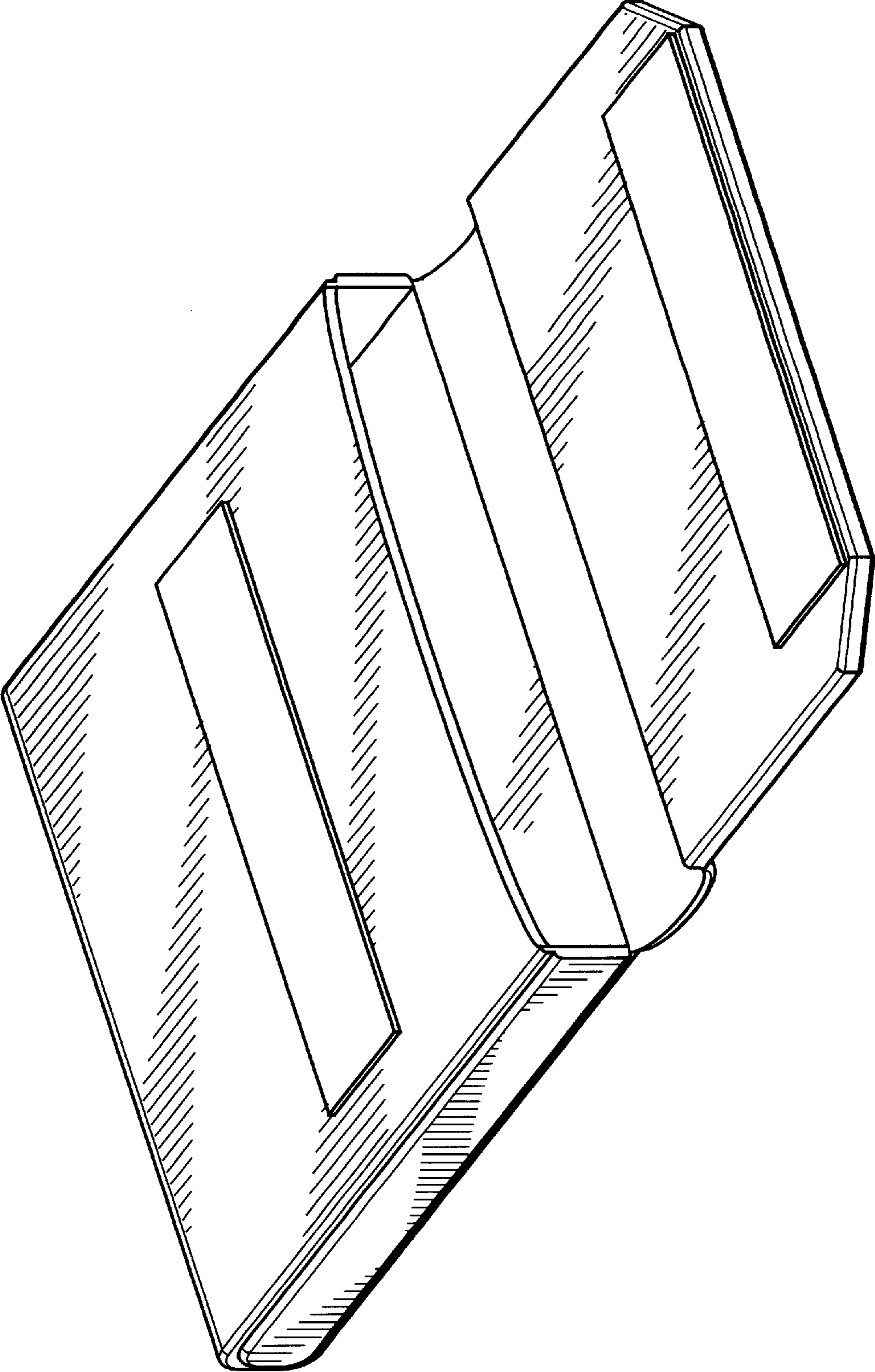

Fig. 3

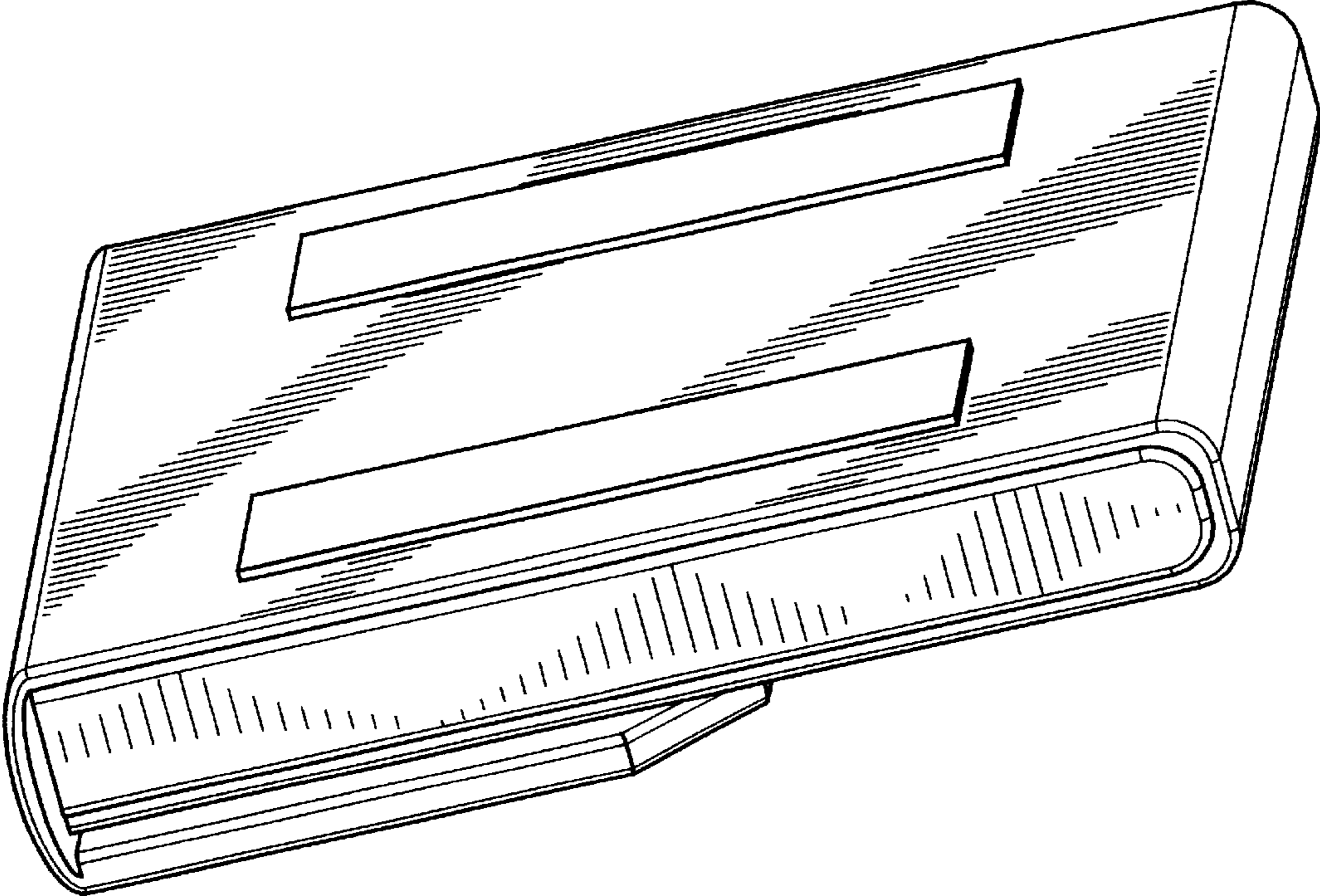

Fig. 4

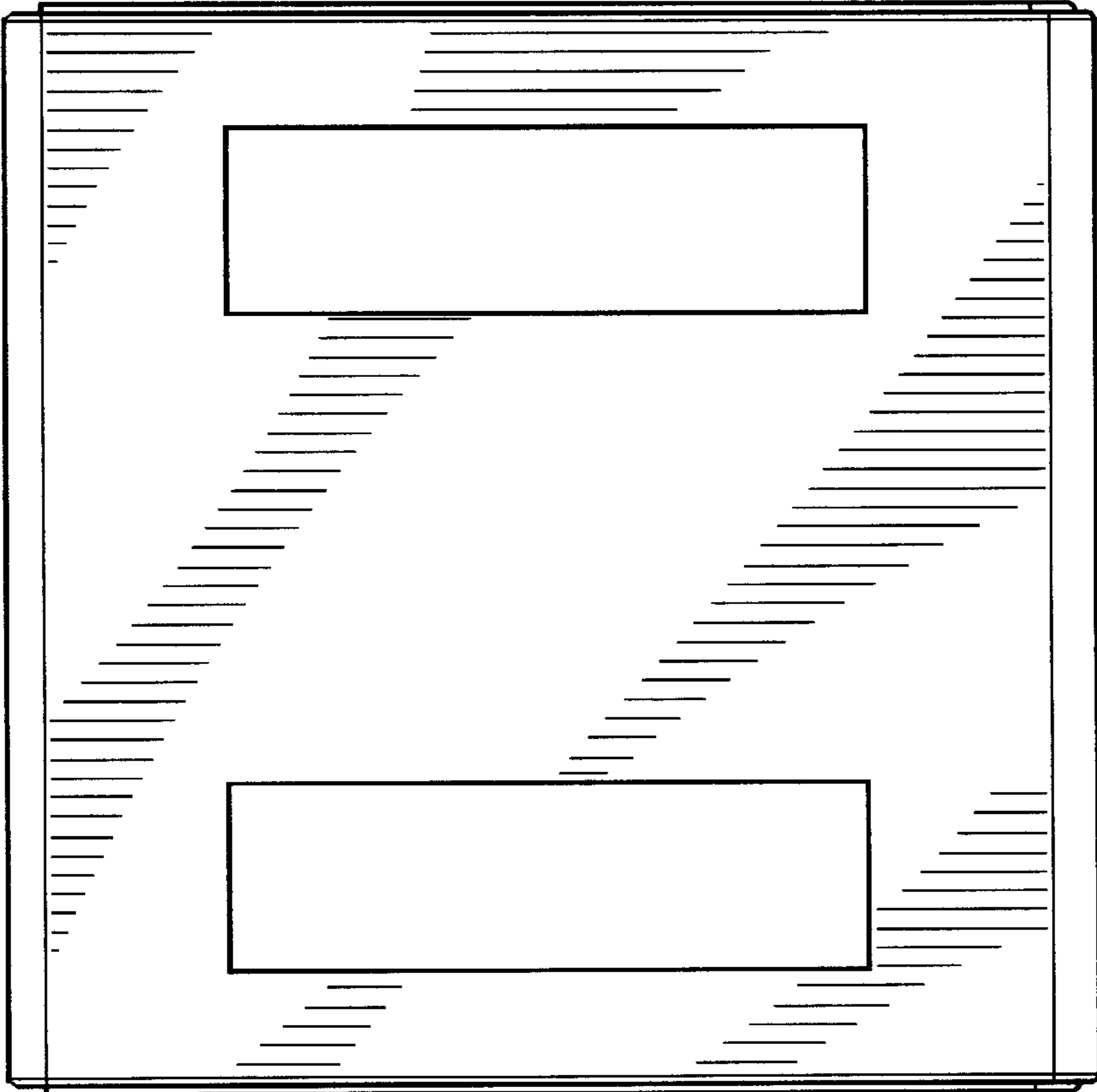

Fig. 5

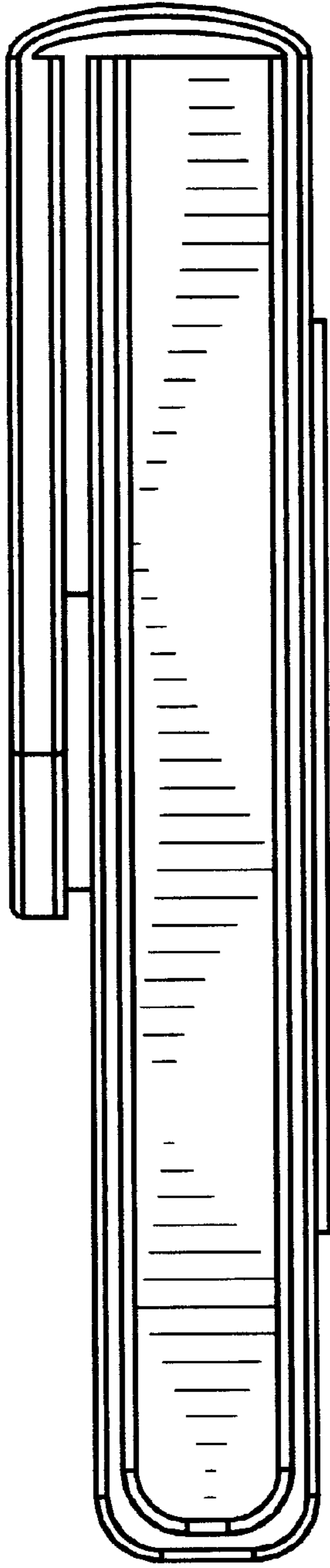

Fig. 6