



US00D525003S

(12) **United States Design Patent**
Mount et al.

(10) **Patent No.:** **US D525,003 S**

(45) **Date of Patent:** **** Jul. 11, 2006**

(54) **DOCKING MODULE FOR A GUN WASHER**

D458,340 S * 6/2002 Lindahl D23/207

(75) Inventors: **Dennis William Mount**, Ottawa (CA);
Charles Harland, Embrum (CA);
Mathieu Fredette, Gloucester (CA)

* cited by examiner

(73) Assignee: **ChemChamp (Barbados) Inc.**,
Bridgetown (KN)

Primary Examiner—Louis S. Zarfaz
Assistant Examiner—Kathleen Sims

(74) *Attorney, Agent, or Firm*—Dilip C. Andrade; Borden
Ladner Gervais LLP

(**) Term: **14 Years**

(57) **CLAIM**

(21) Appl. No.: **29/199,880**

We claim the ornamental design for the docking module for
a gun washer, as shown and described.

(22) Filed: **Feb. 23, 2004**

DESCRIPTION

(30) **Foreign Application Priority Data**

Feb. 20, 2004 (CA) 105968

FIG. 1 illustrates a front perspective view of the docking
module;

(51) **LOC (8) Cl.** **15-05**

FIG. 2 illustrates a side view, the opposite side view being
a mirror image;

(52) **U.S. Cl.** **D32/25**

(58) **Field of Classification Search** D32/15,
D32/1, 25; D23/200, 207, 209; 202/81, 83,
202/185.2

FIG. 3 illustrates a rear view;

FIG. 4 illustrates a top view;

See application file for complete search history.

FIG. 5 illustrates a bottom view; and,

FIG. 6 illustrates a front perspective view of the docking
module located in a gun washer.

(56) **References Cited**

U.S. PATENT DOCUMENTS

D455,813 S * 4/2002 Mount D23/207

1 Claim, 3 Drawing Sheets

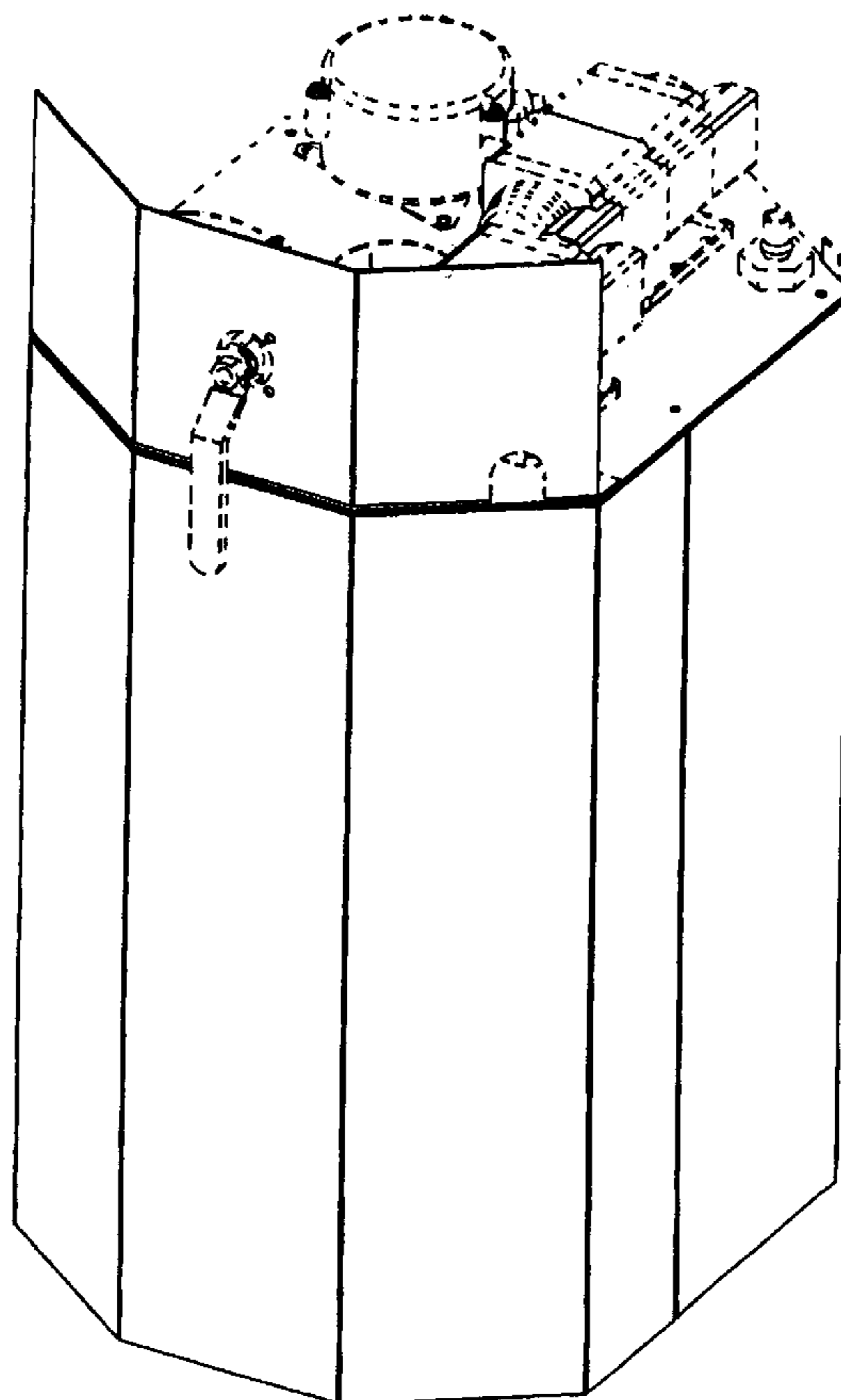

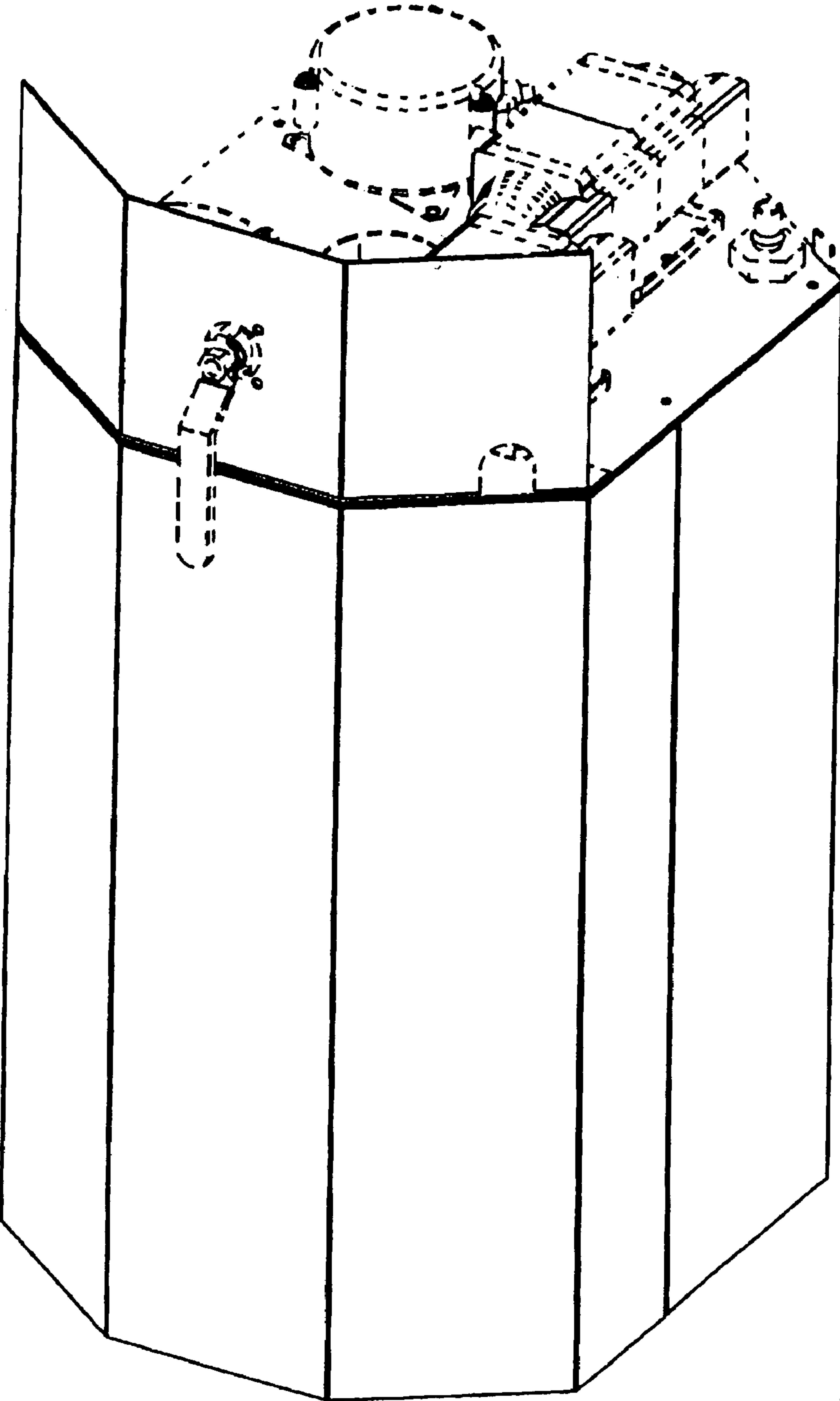

FIG. 1

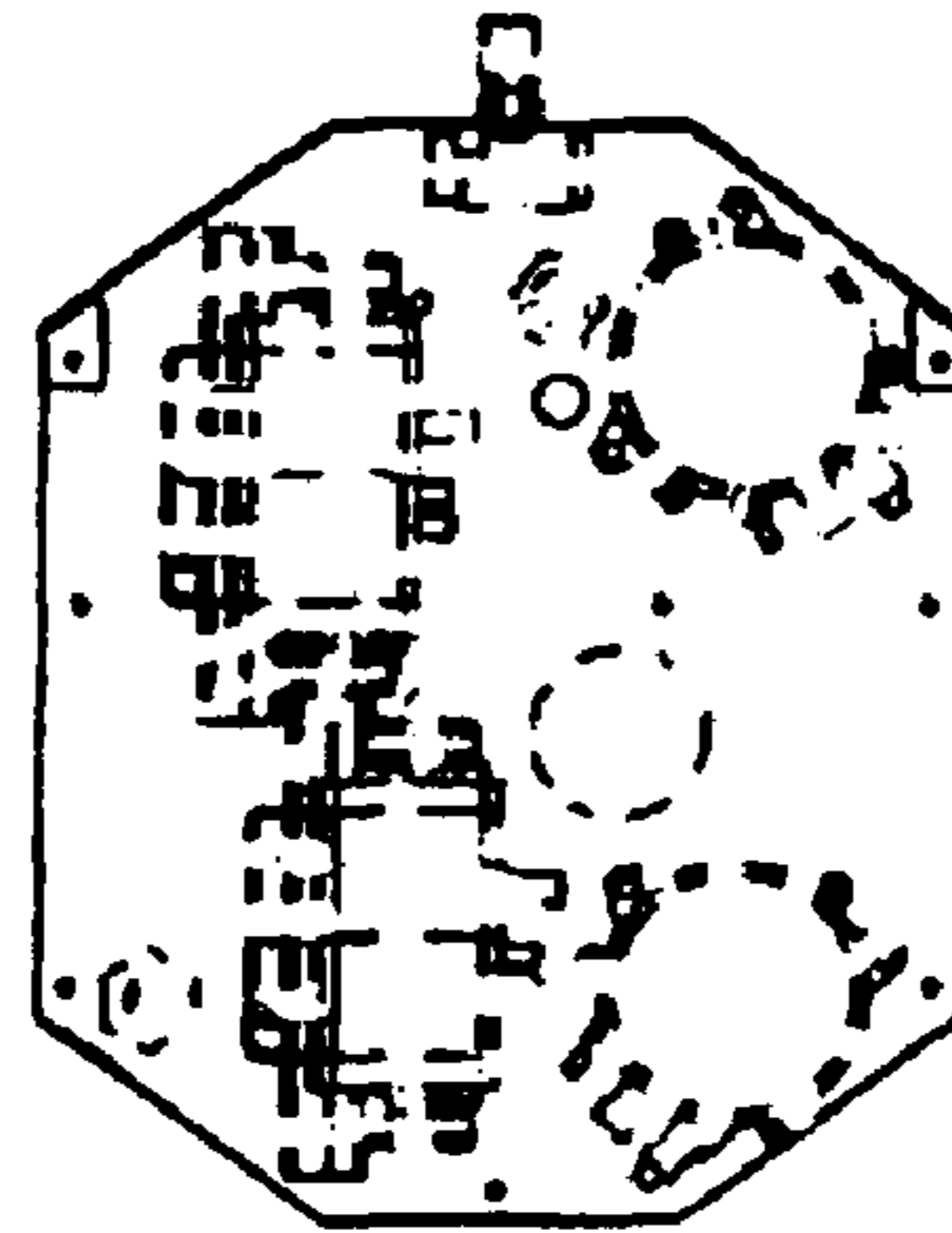

FIG. 4

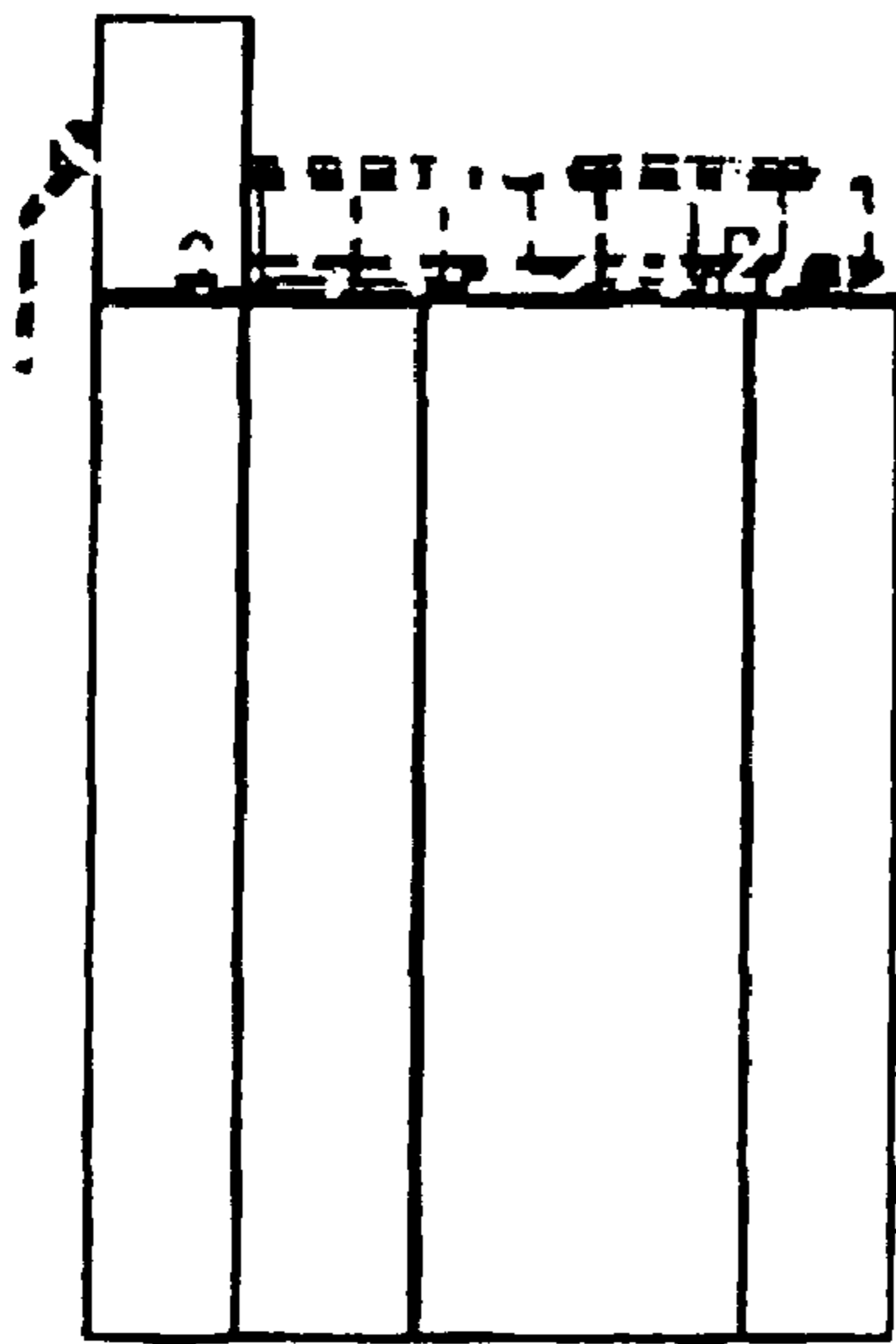

FIG. 2

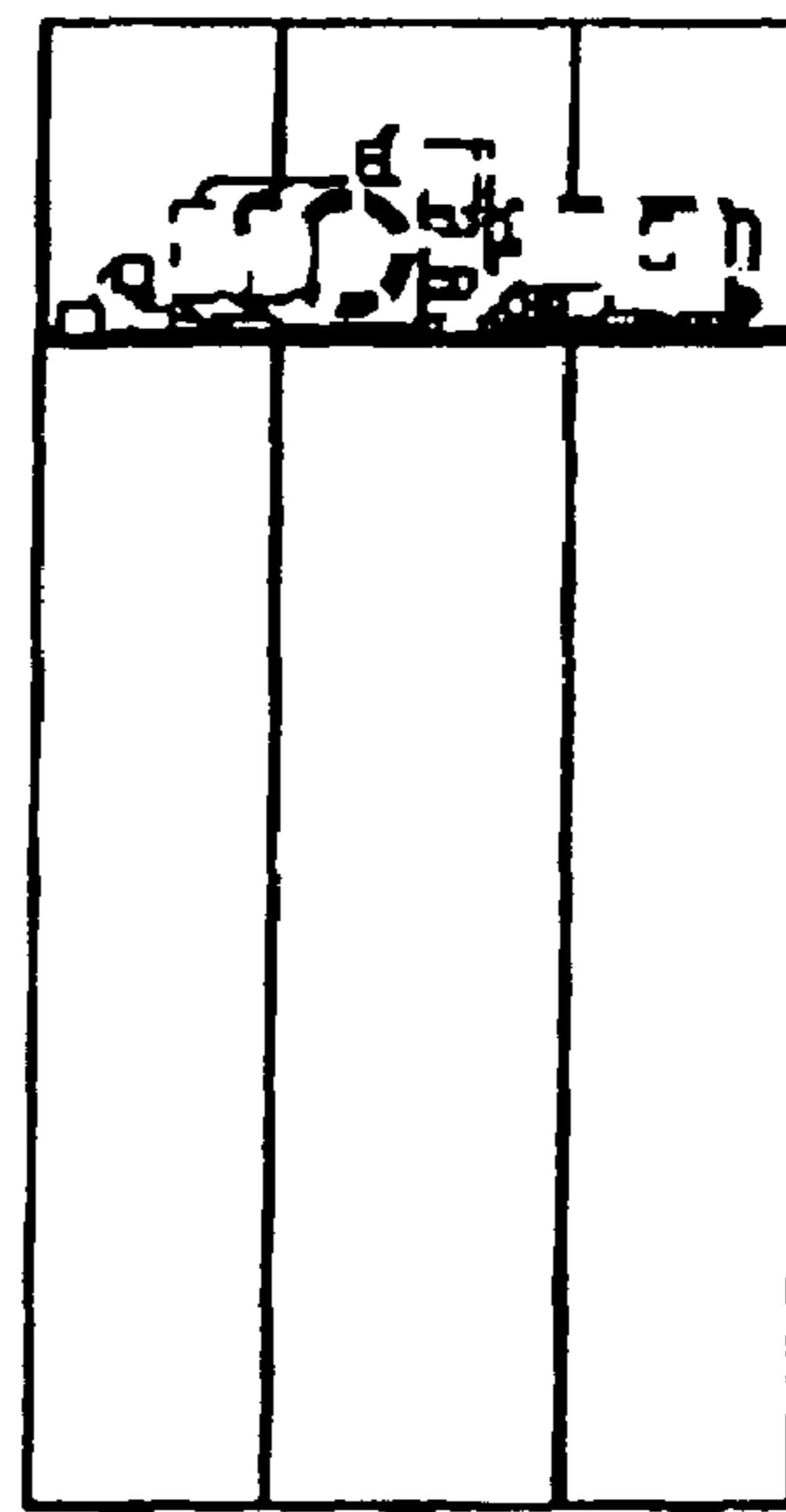

FIG. 3

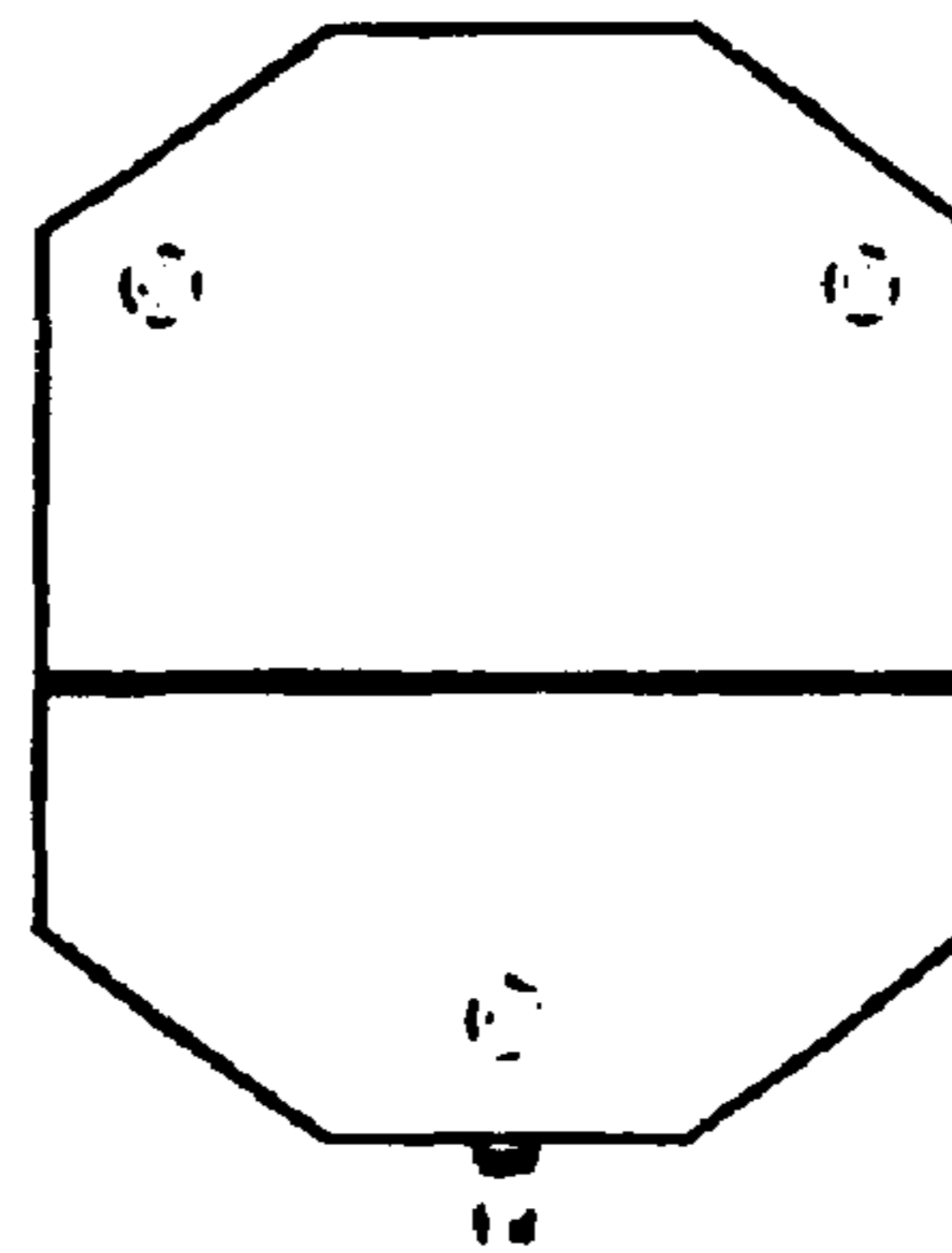

FIG. 5

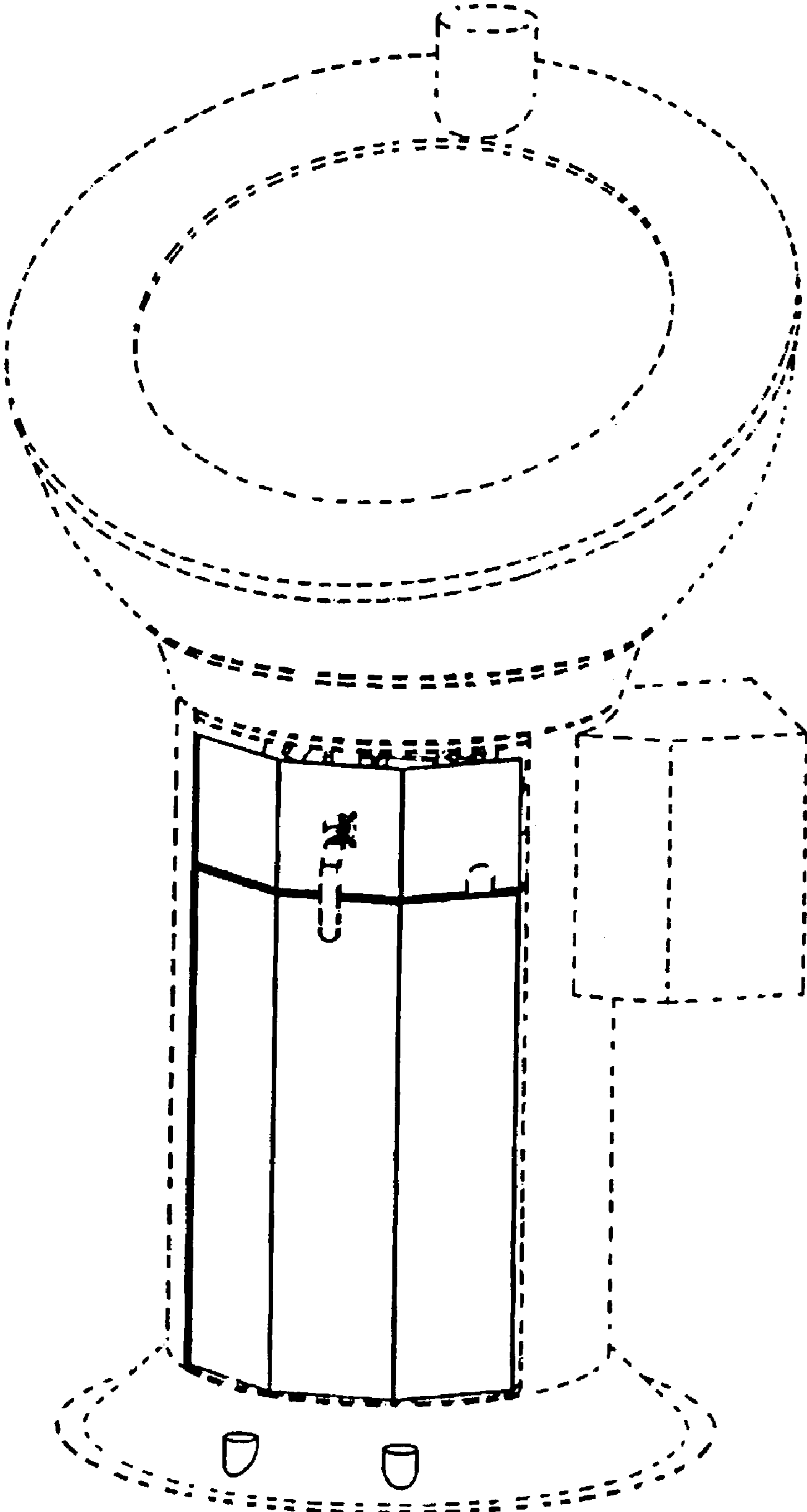

FIG. 6