



US00D524961S

(12) **United States Design Patent**
Garrity

(10) **Patent No.:** **US D524,961 S**

(45) **Date of Patent:** **** Jul. 11, 2006**

(54) **FLASHLIGHT**

D445,925 S * 7/2001 Parker D26/37
D477,102 S * 7/2003 Yuen D26/37

(75) Inventor: **Paul G. Garrity**, Clinton, CT (US)

* cited by examiner

(73) Assignee: **Garrity Industries, Inc.**, Madison, CT (US)

Primary Examiner—Marcus A. Jackson

(74) *Attorney, Agent, or Firm*—Fitzpatrick, Cella, Harper & Scinto

(**) Term: **14 Years**

(57) **CLAIM**

(21) Appl. No.: **29/229,454**

The ornamental design for a flashlight, as shown and described.

(22) Filed: **May 9, 2005**

DESCRIPTION

(51) **LOC (8) Cl.** **26-02**

(52) **U.S. Cl.** **D26/37**

(58) **Field of Classification Search** D26/37–50;
362/157, 158, 171–174, 183–208

See application file for complete search history.

FIG. 1 is a perspective view as viewed from a front direction thereof of a flashlight showing my new design;

FIG. 2 is a top view thereof;

FIG. 3 is a right side view thereof;

FIG. 4 is a bottom view thereof;

FIG. 5 is a left side view thereof;

FIG. 6 is a front view thereof; and,

FIG. 7 is a rear view thereof.

(56) **References Cited**

U.S. PATENT DOCUMENTS

D376,859 S * 12/1996 Garrity, Sr. D26/37

D443,085 S * 5/2001 Dalton et al. D26/37

1 Claim, 4 Drawing Sheets

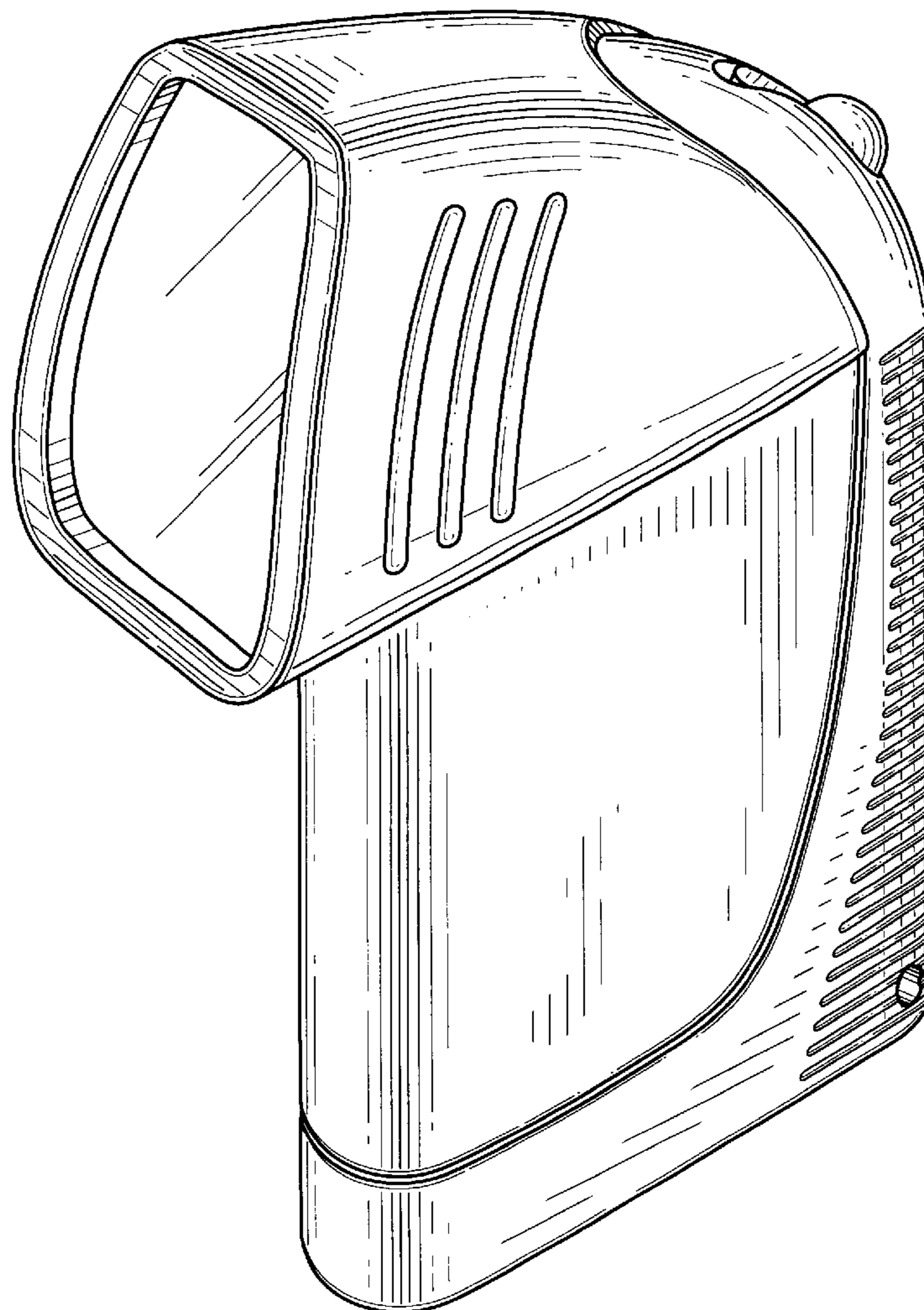

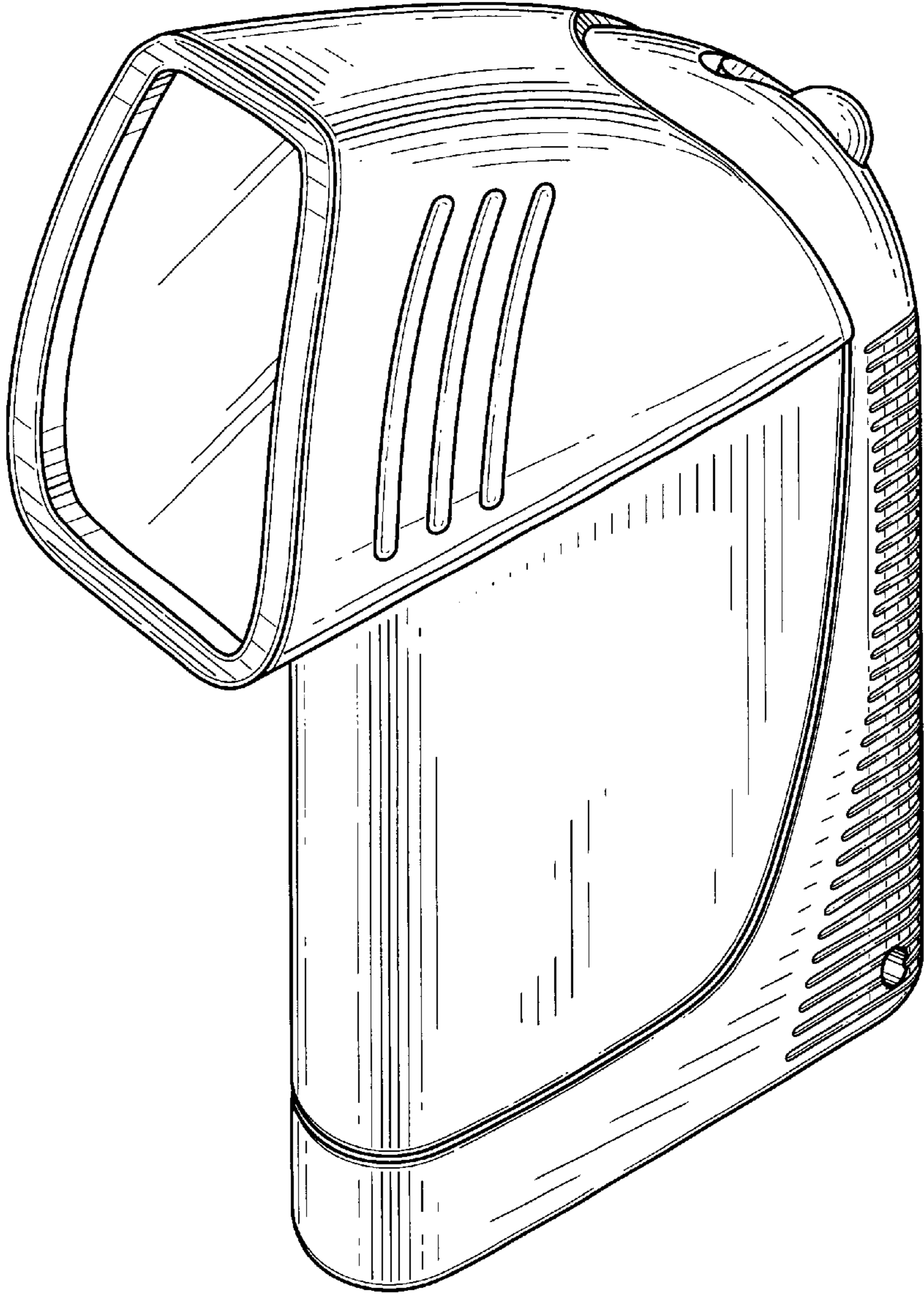

FIG. 1

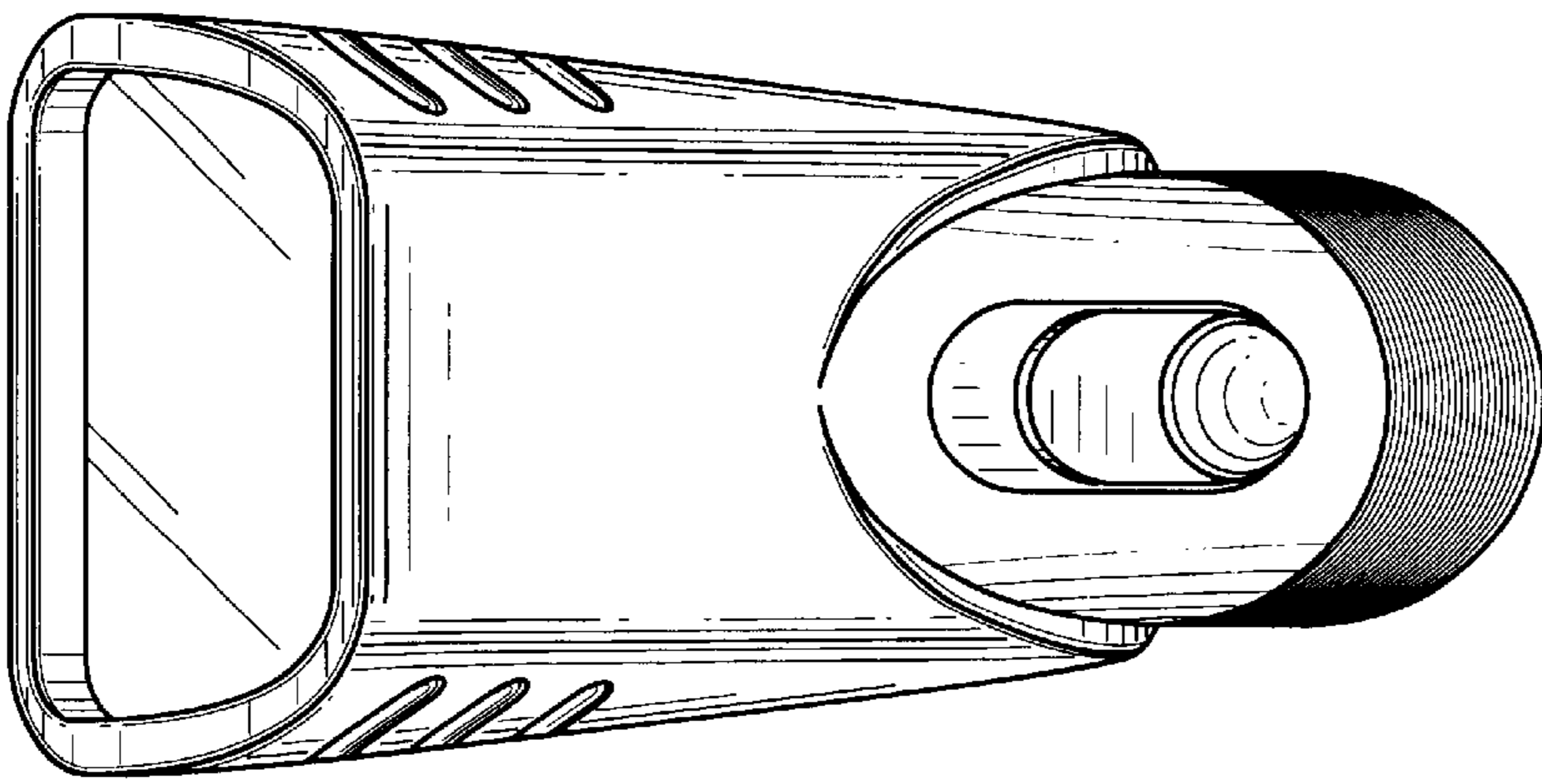

FIG. 2

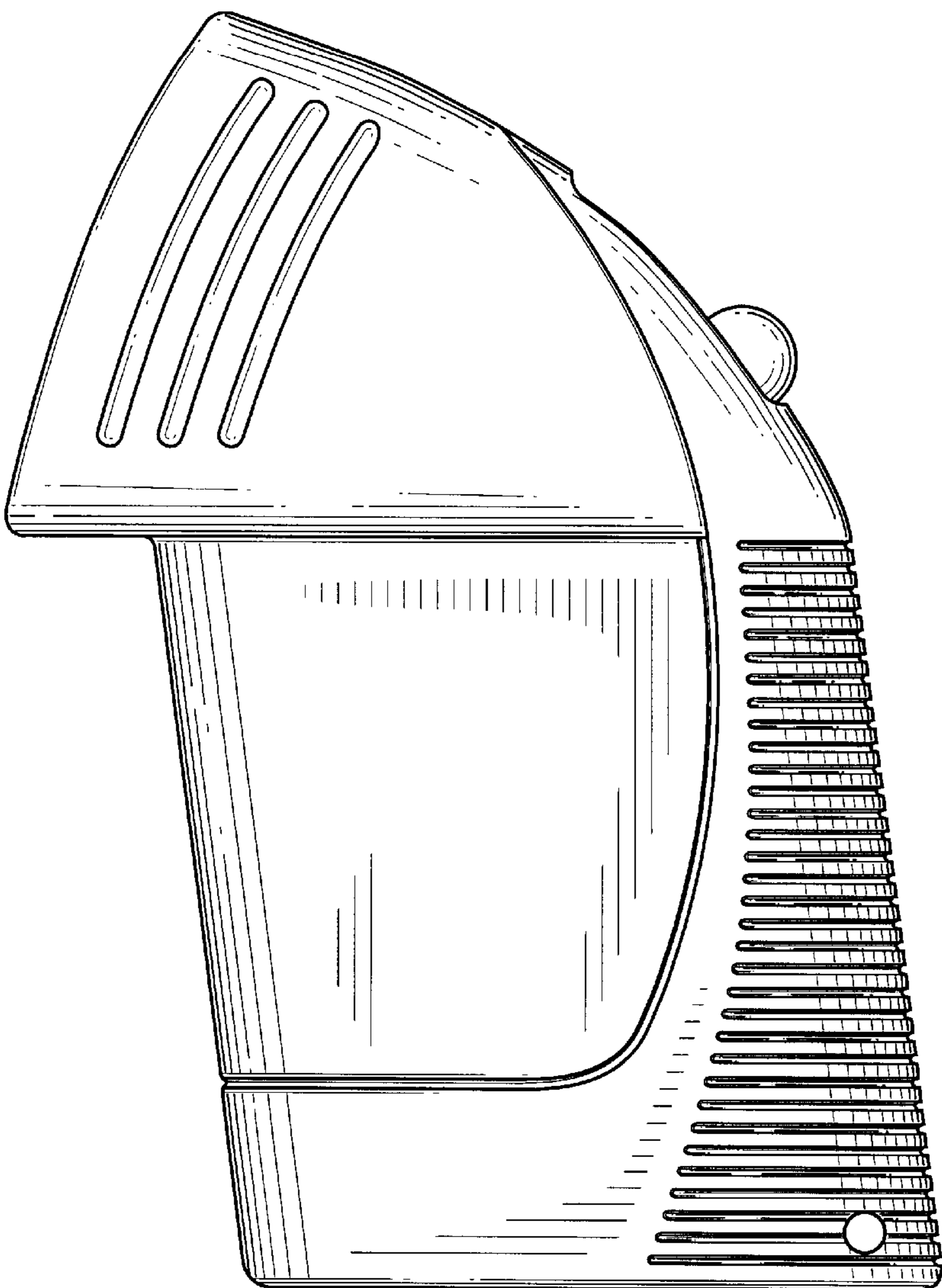

FIG. 3

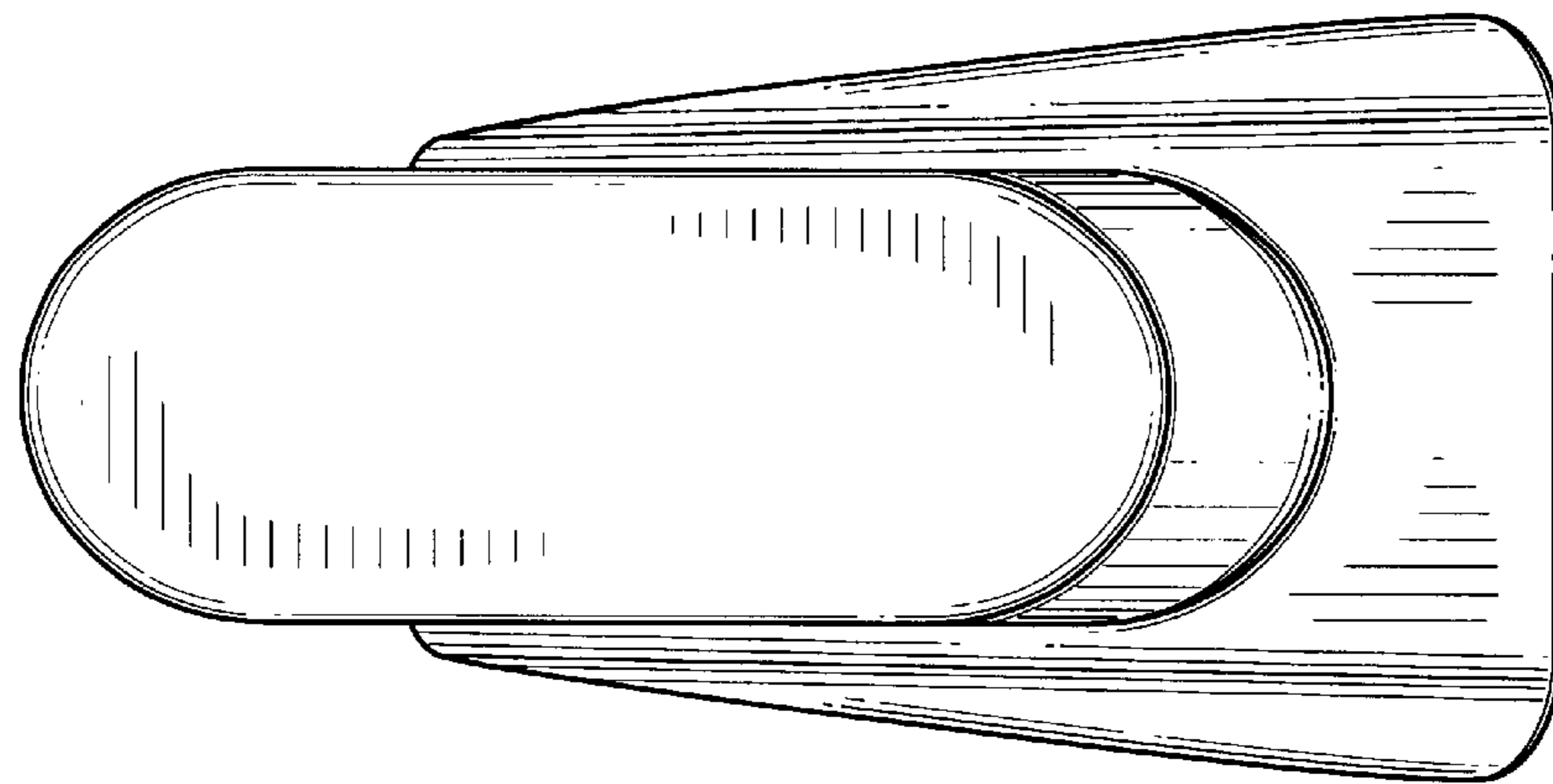

FIG. 4

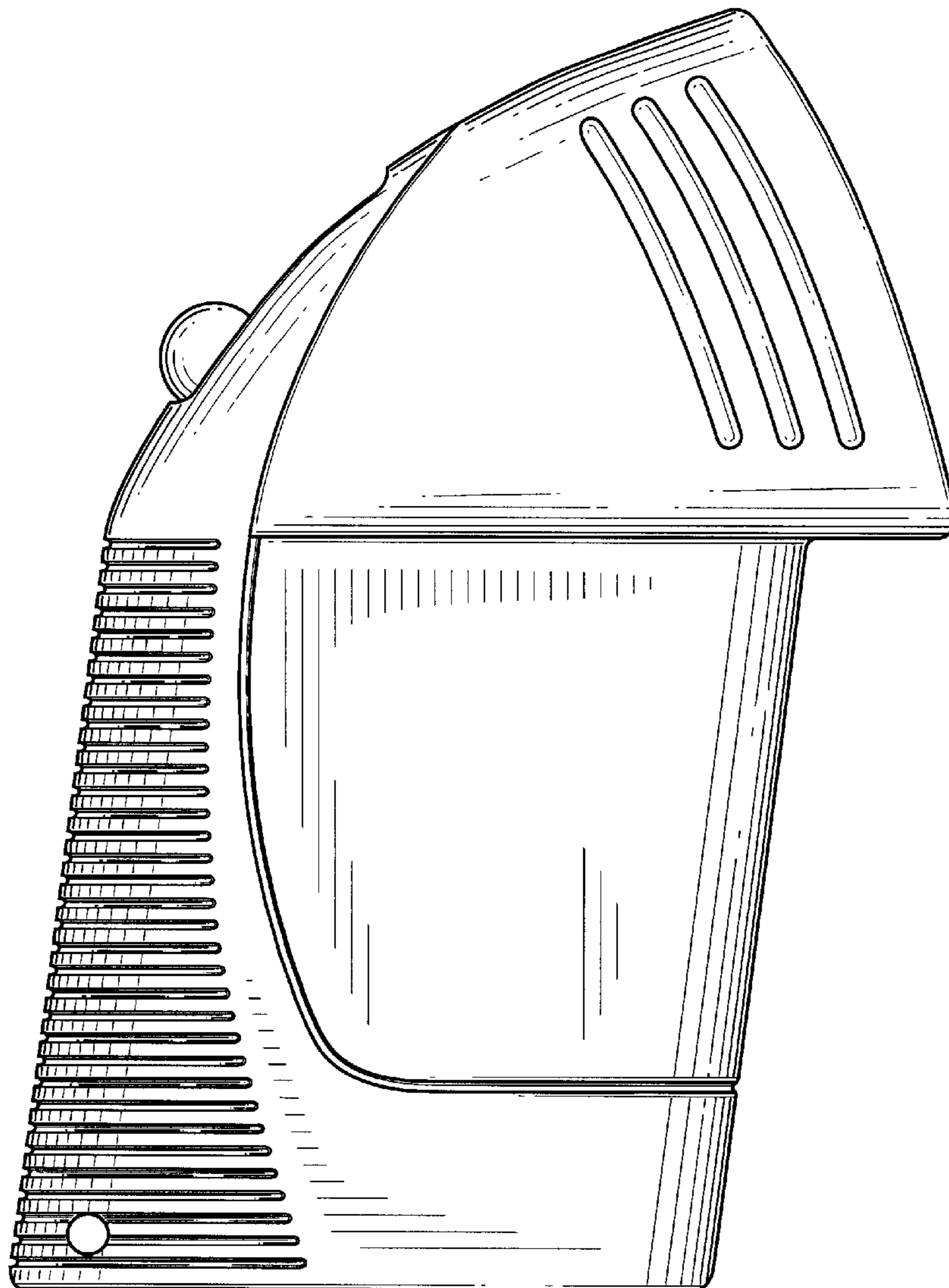

FIG. 5

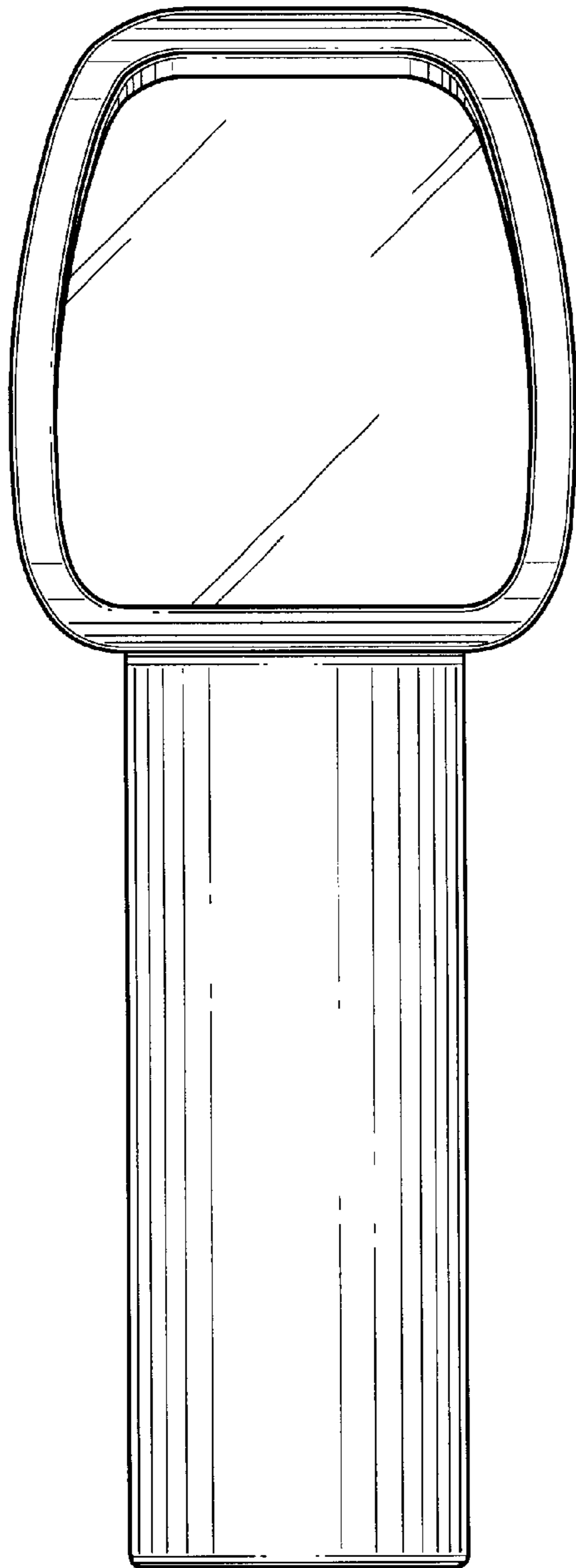

FIG. 6

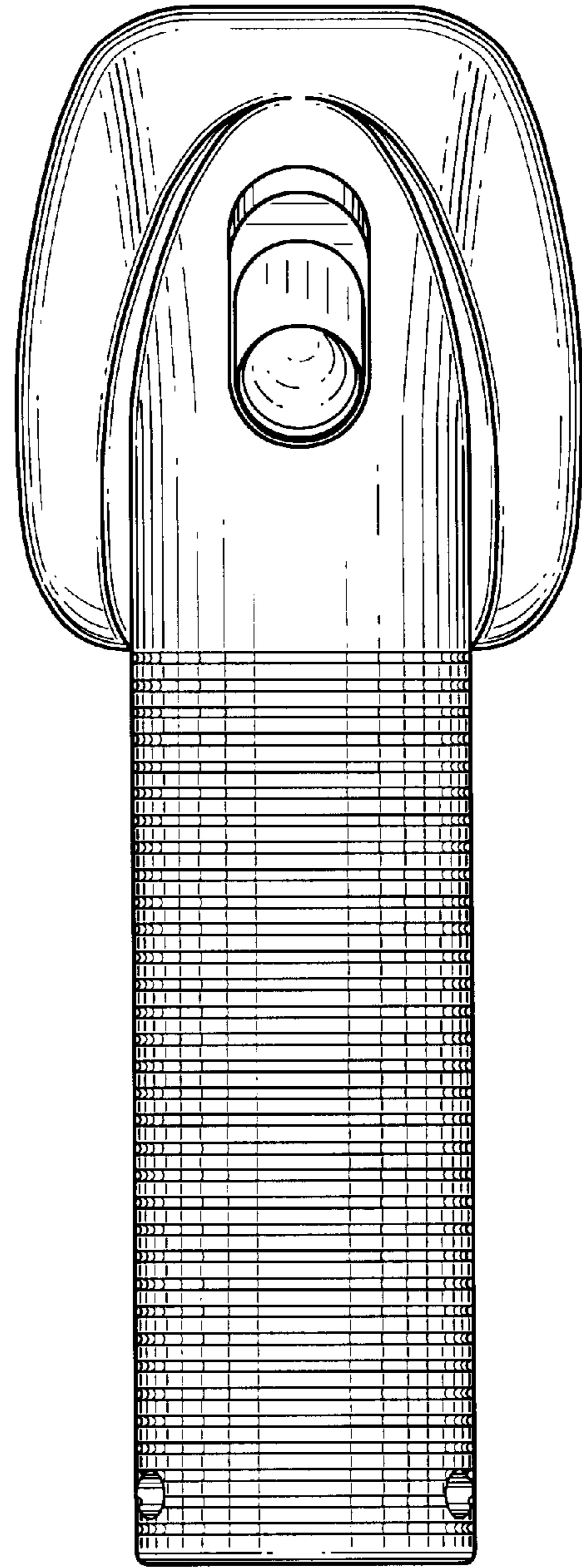

FIG. 7