

US00D524926S

(12) **United States Design Patent** (10) **Patent No.:** **US D524,926 S**
Lebrun et al. (45) **Date of Patent:** **** Jul. 11, 2006**

(54) **BATHTUB**

(75) Inventors: **Bernard Lebrun**, St-Joseph-de-Lévis (CA); **Gabriel Boutin**, Saint-Jean-Chysostome (CA); **Bruno Côté**, Saint-Isidore (CA); **Steve Donnelly**, Saint-Antoine-de-Tilly (CA); **Sylvain Dufour**, Lachenaie (CA); **Nicolas Lebrun**, St-Isidore (CA); **John Penterman**, Montréal (CA); **Suzanne Ouellette**, Montréal (CA)

(73) Assignee: **Maax Canada Inc.**, Montreal (CA)

(**) Term: **14 Years**

(21) Appl. No.: **29/220,151**

(22) Filed: **Dec. 28, 2004**

(30) **Foreign Application Priority Data**

Jun. 28, 2004 (CA) 107401

(51) **LOC (8) Cl.** **23-02**

(52) **U.S. Cl.** **D23/280.1**

(58) **Field of Classification Search** D23/273, D23/276-277, 280.1-280.3, 303-306, 284, D23/293.1, 308; D24/204-205; 4/538, 584

See application file for complete search history.

(56) **References Cited**

U.S. PATENT DOCUMENTS

505,041 A * 9/1893 Fergeson 4/584
D266,692 S * 10/1982 Harrison D23/280.1
D510,984 S * 10/2005 Matthews et al. D23/280.1

* cited by examiner

Primary Examiner—Robert A Delehanty

(57) **CLAIM**

The ornamental design of a bathtub, as shown and described.

DESCRIPTION

FIG. 1 is a front perspective view of the bathtub, showing our new design;
FIG. 2 is a top view thereof;
FIG. 3 is a bottom view thereof;
FIG. 4 is a front elevation view thereof;
FIG. 5 is a right side elevation view thereof;
FIG. 6 is a rear elevation view thereof;
FIG. 7 is a left side elevation view thereof;
FIG. 8 is an exploded front perspective view thereof;
FIG. 9 is an exploded front elevation view thereof; and,
FIG. 10 is an exploded right side elevation view thereof.

1 Claim, 3 Drawing Sheets

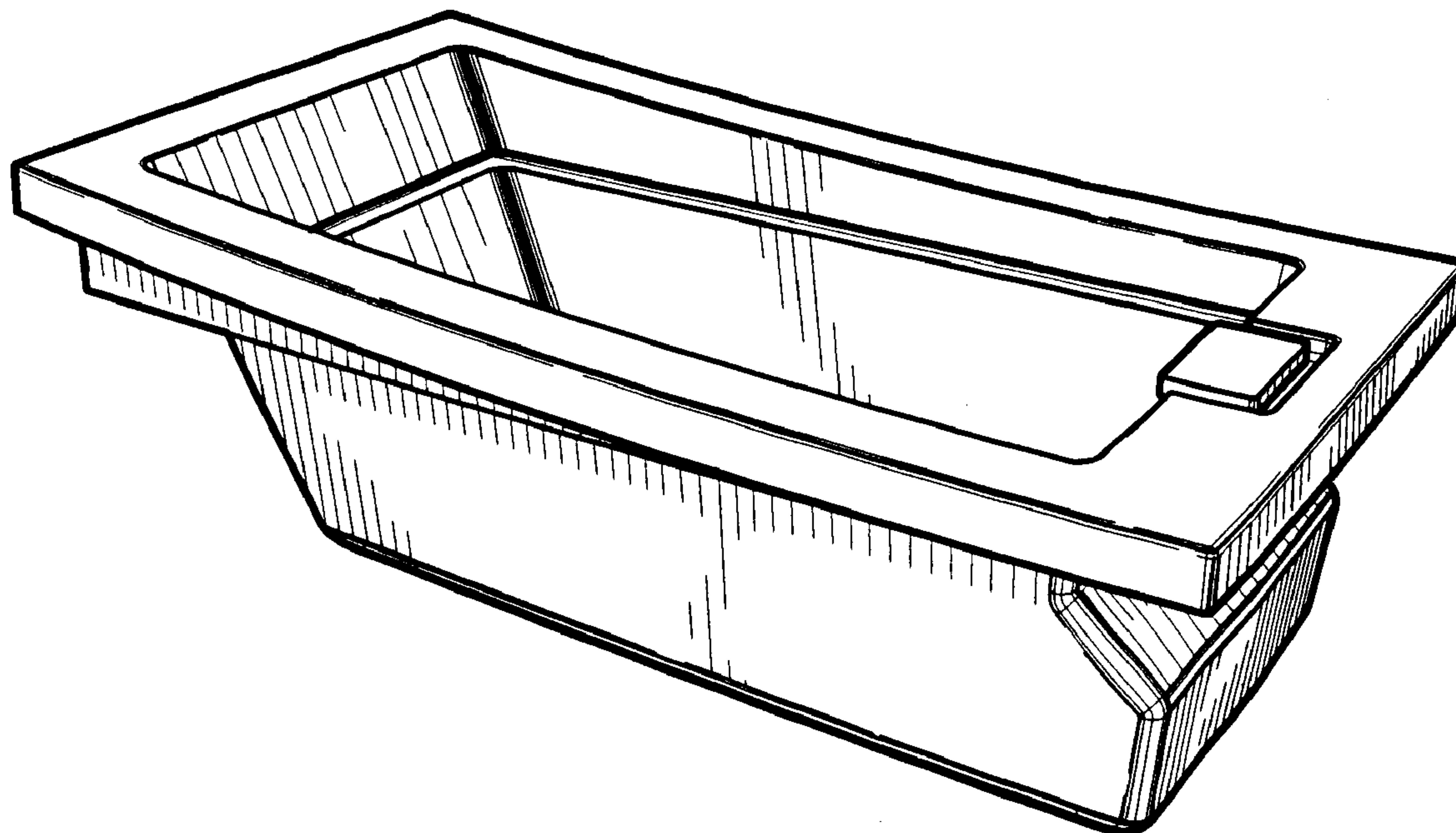

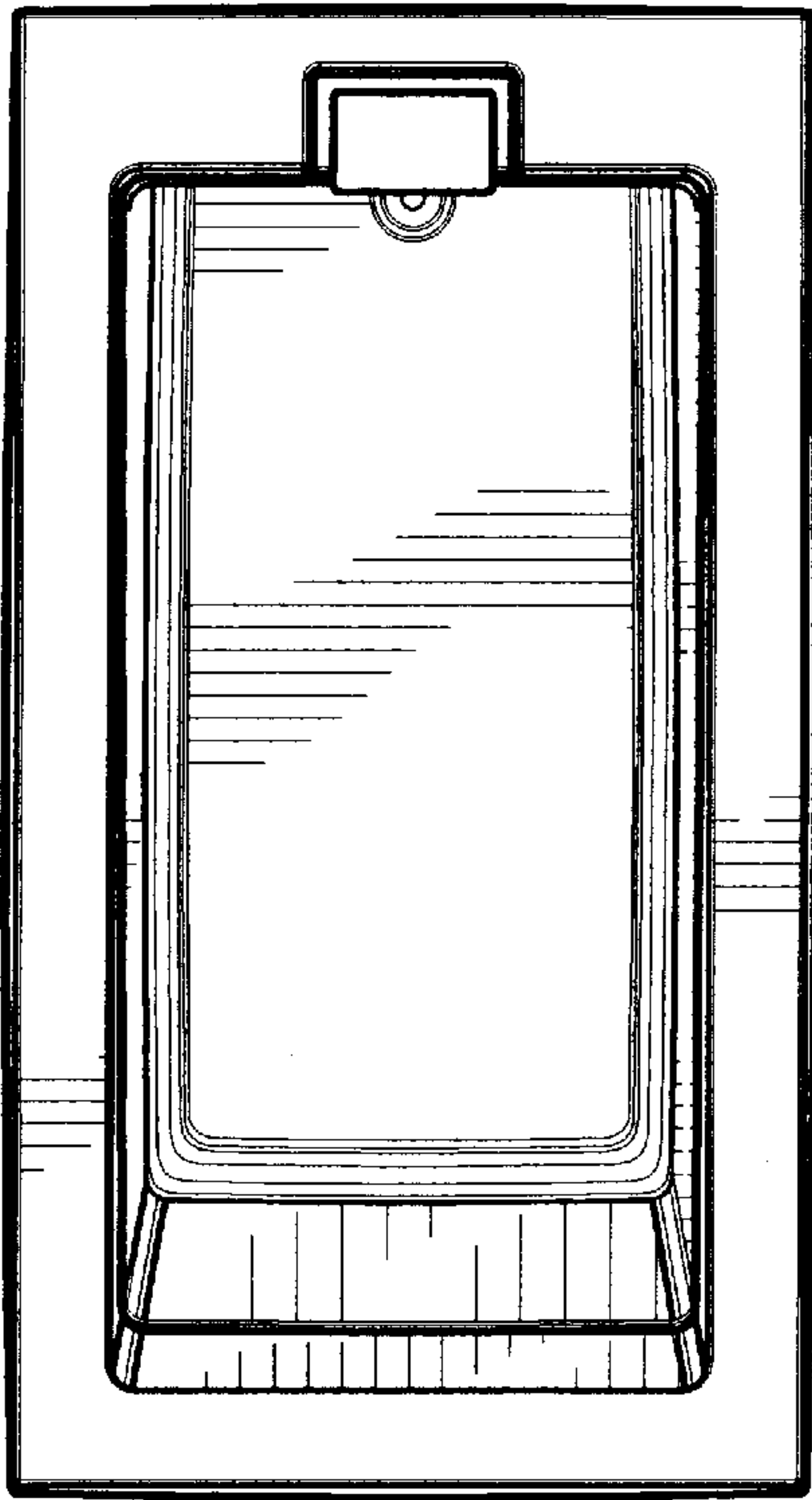

Fig. 2.

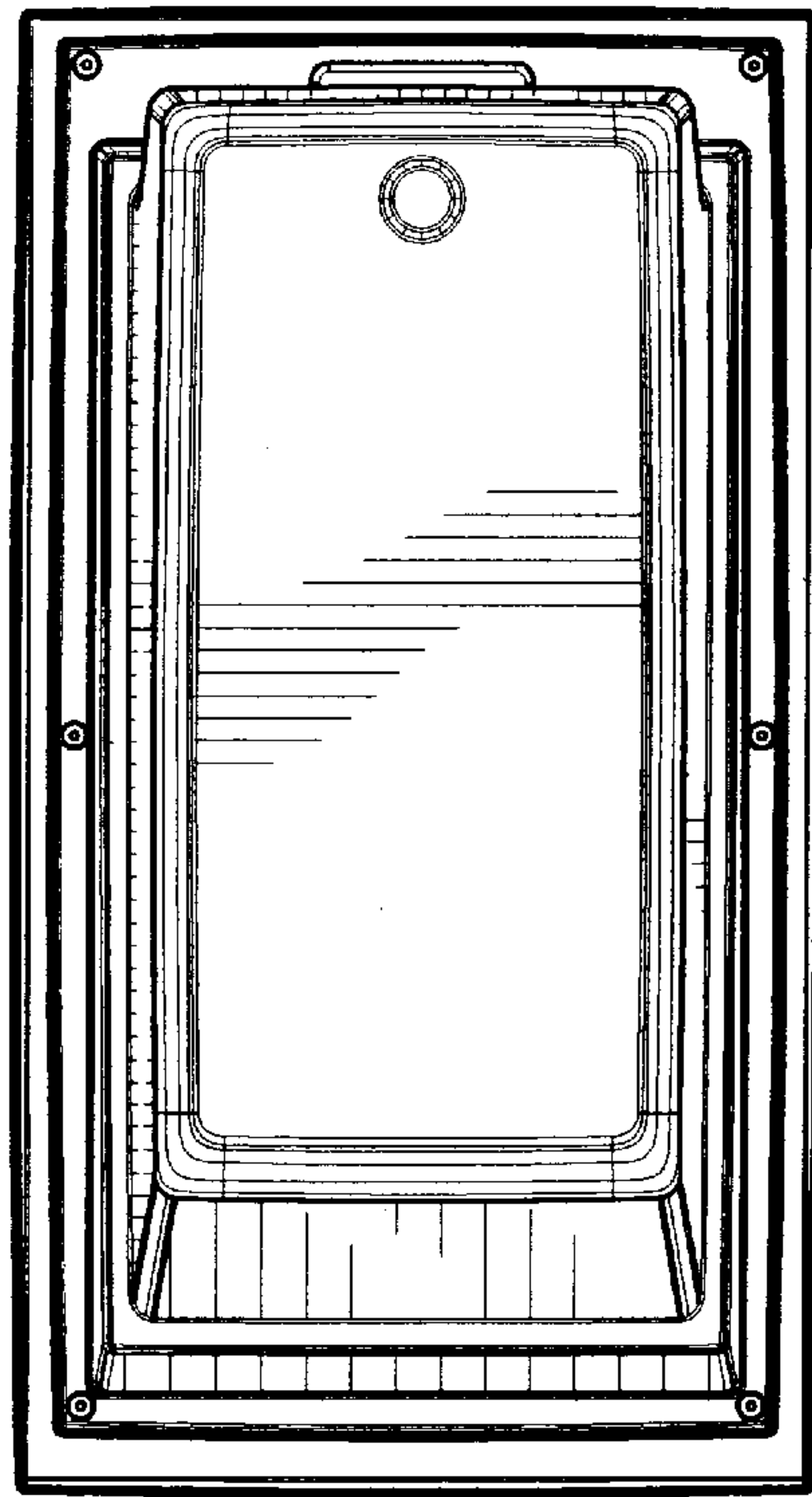

Fig. 3.

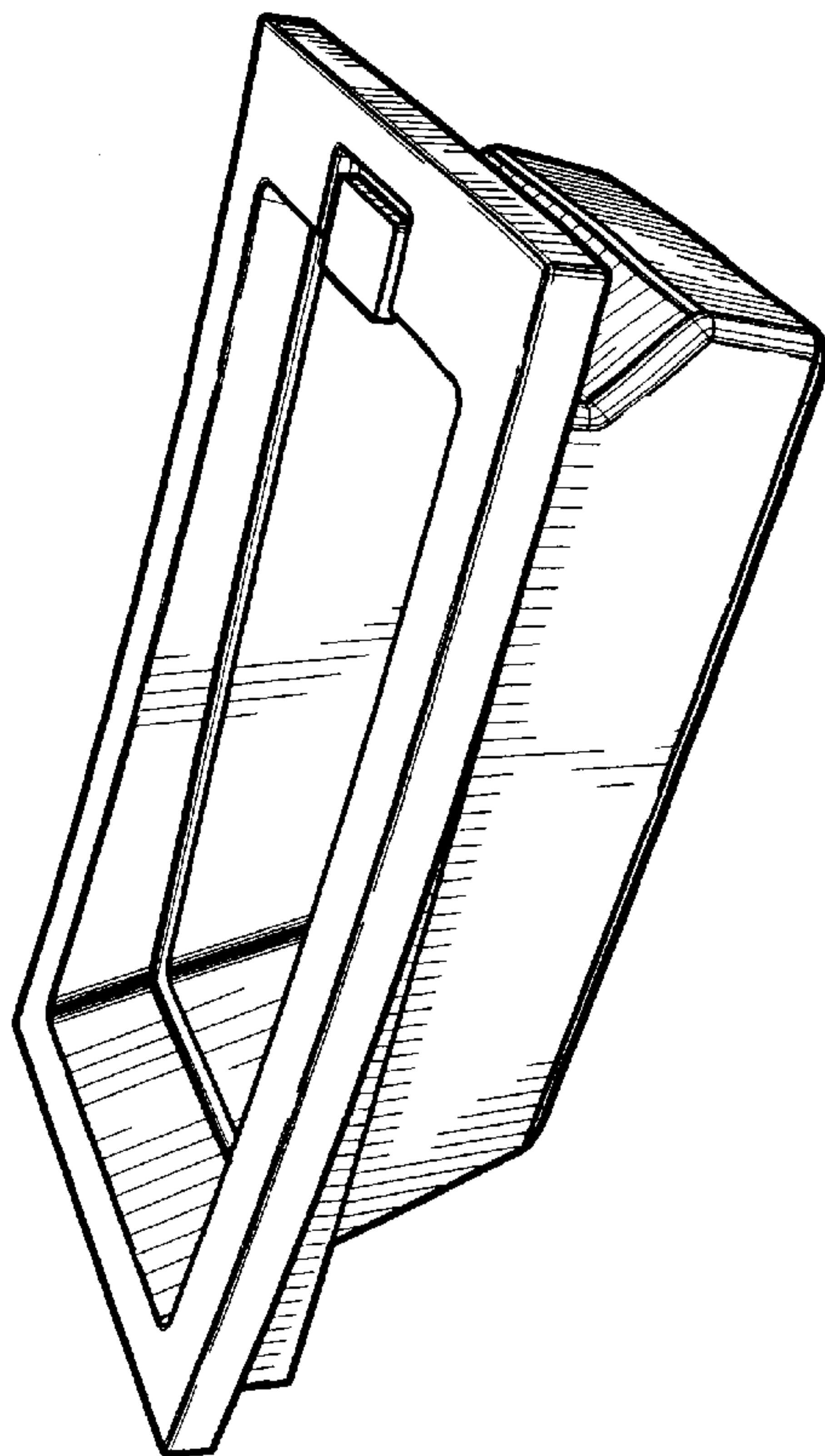

Fig. 1.

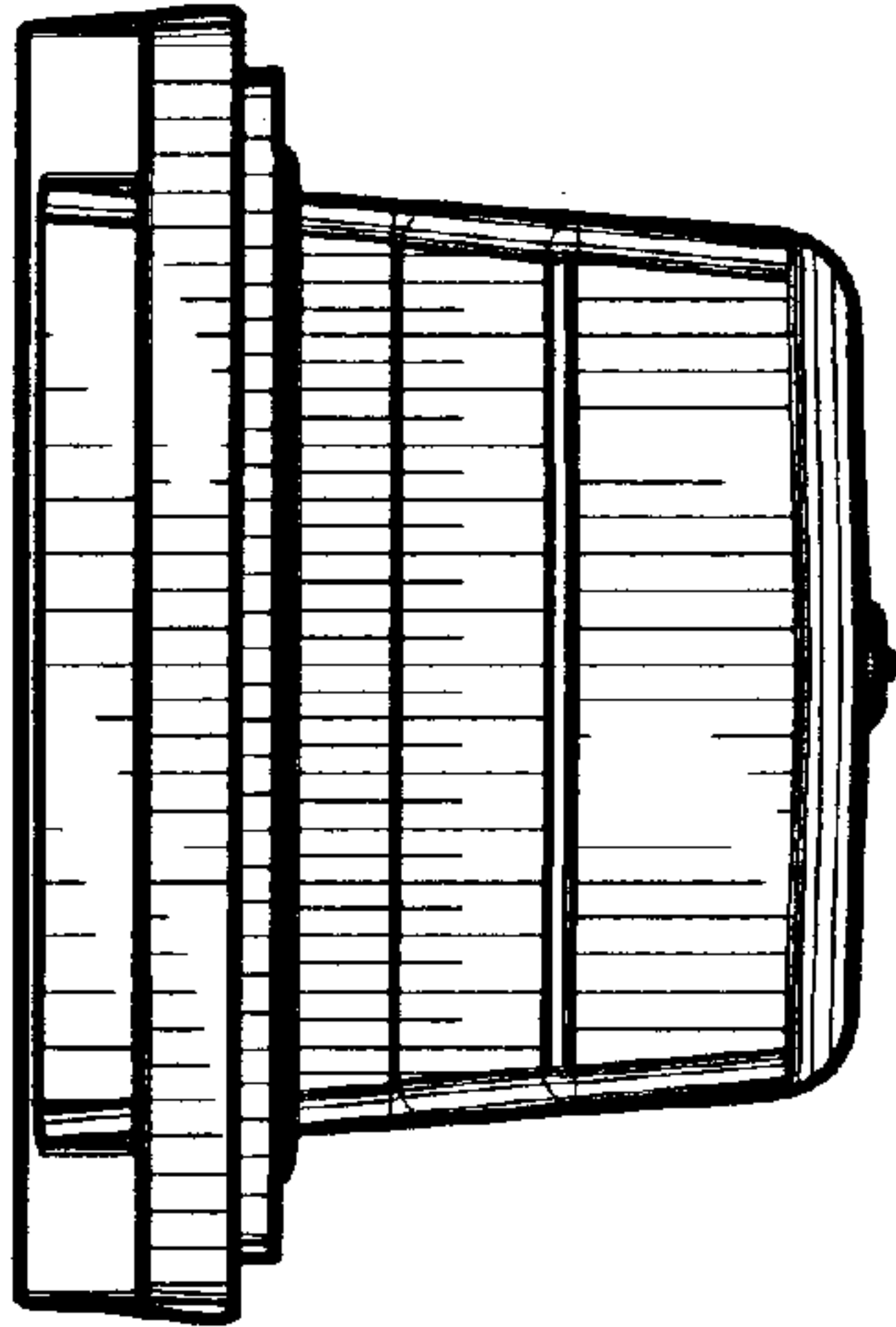

Fig. 5.

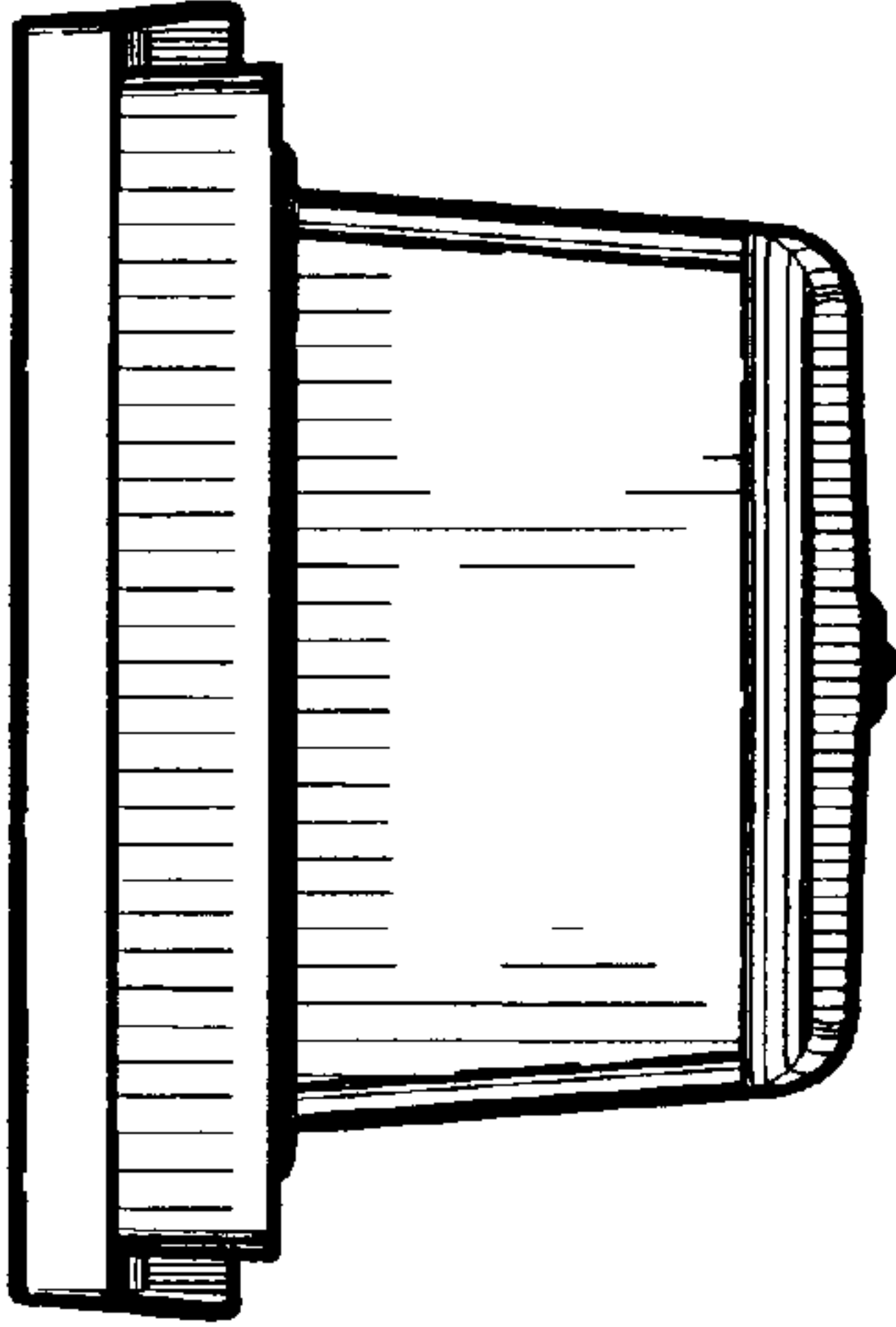

Fig. 7.

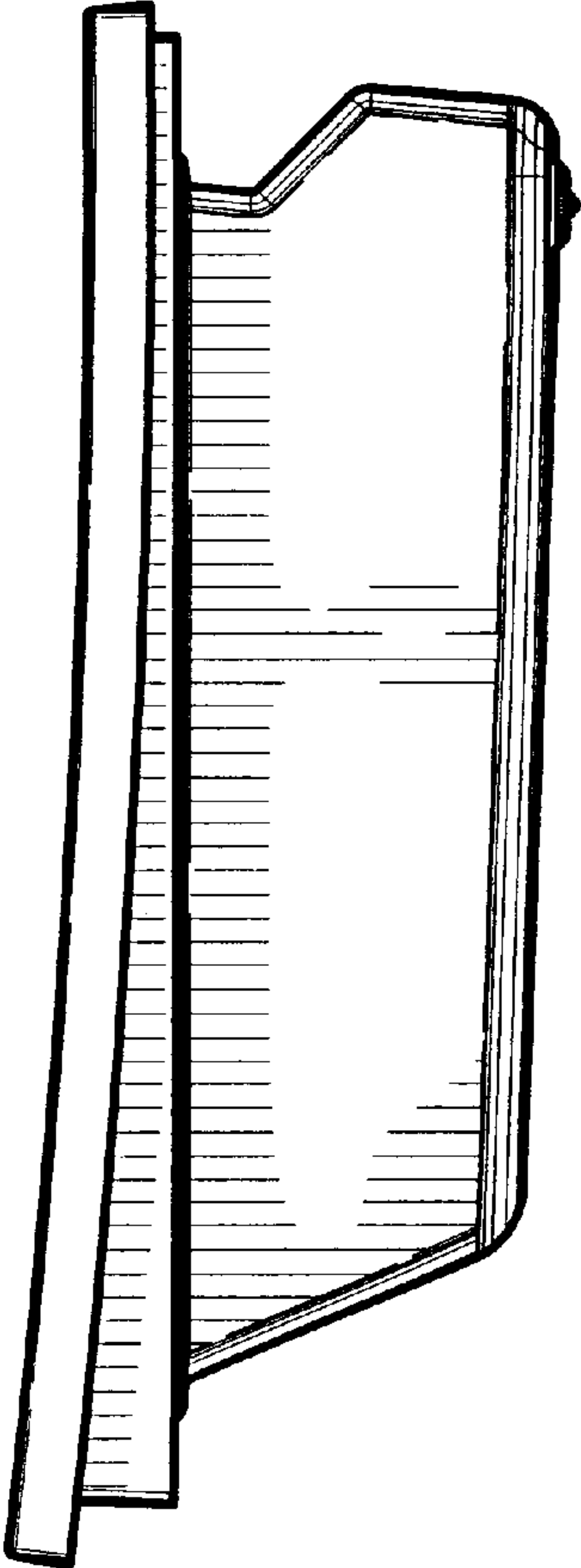

Fig. 4.

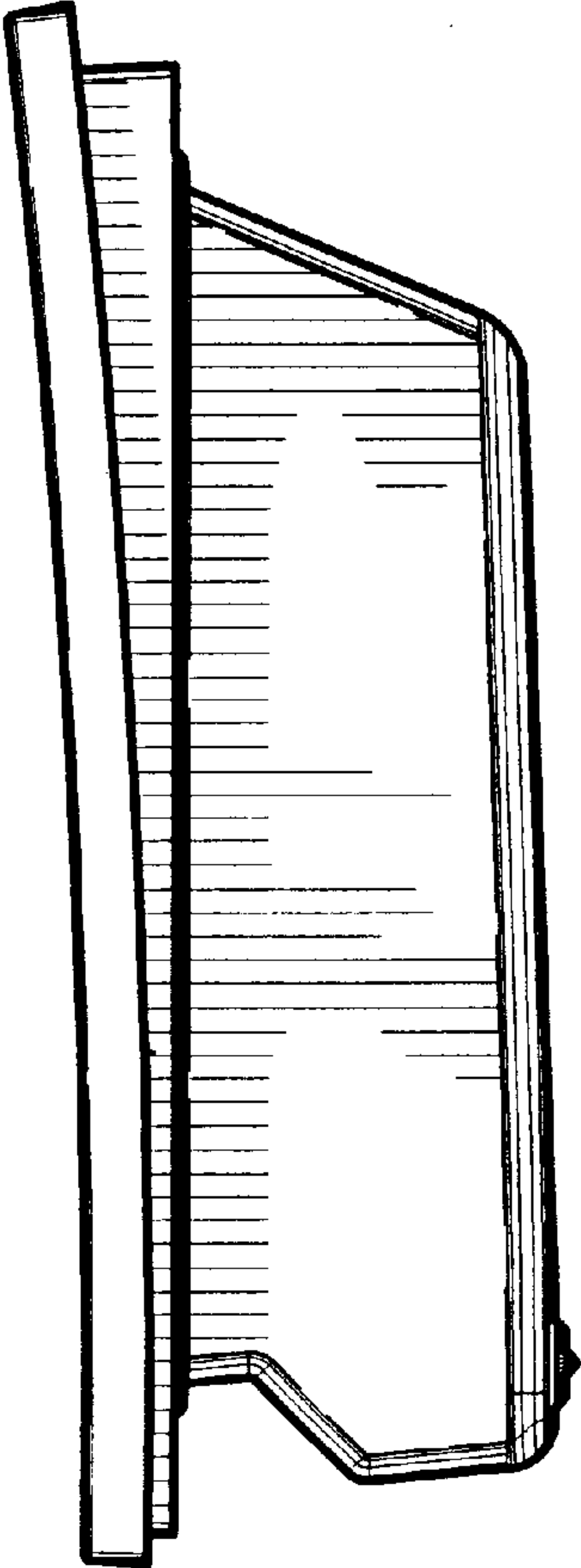

Fig. 6.

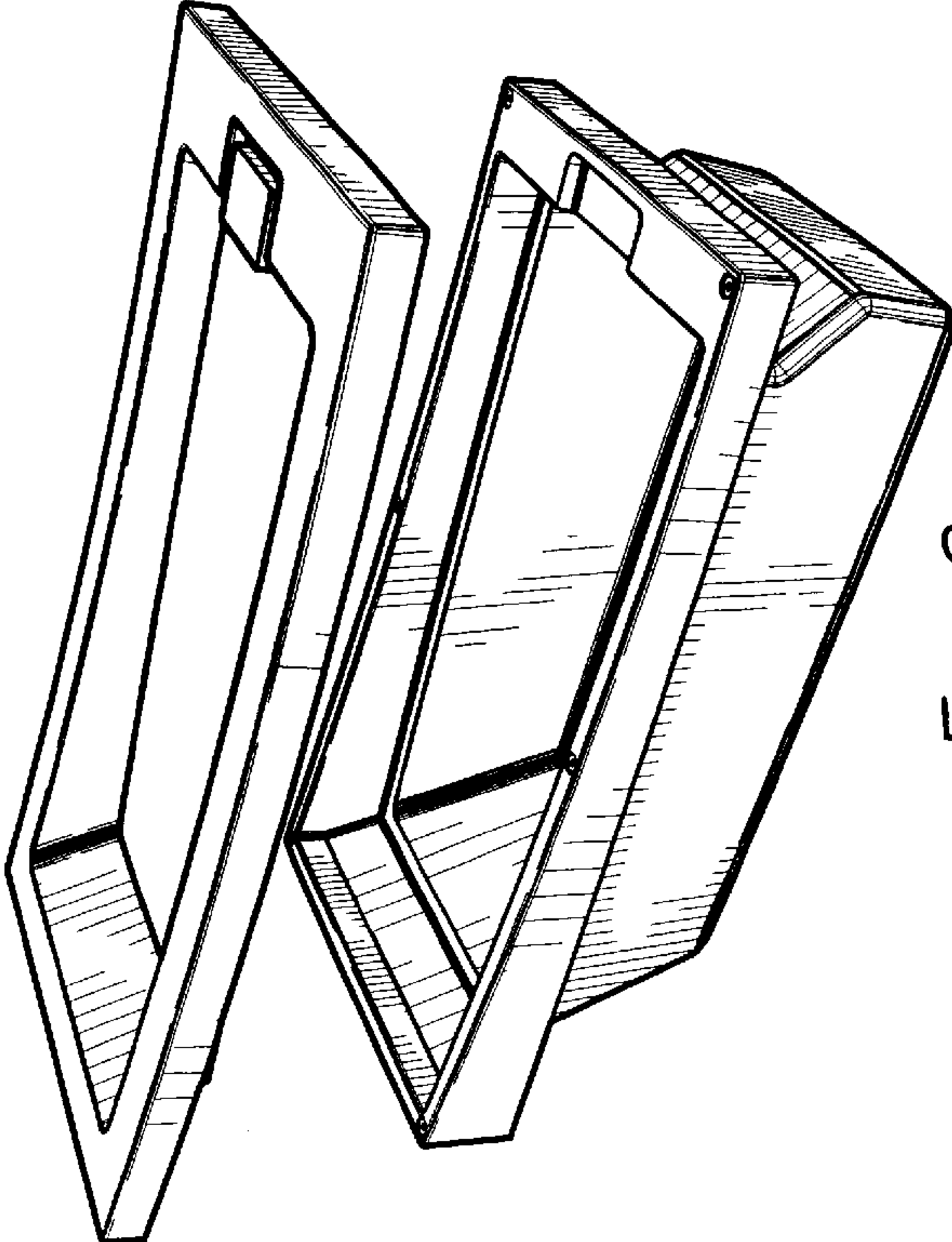

Fig. 8.

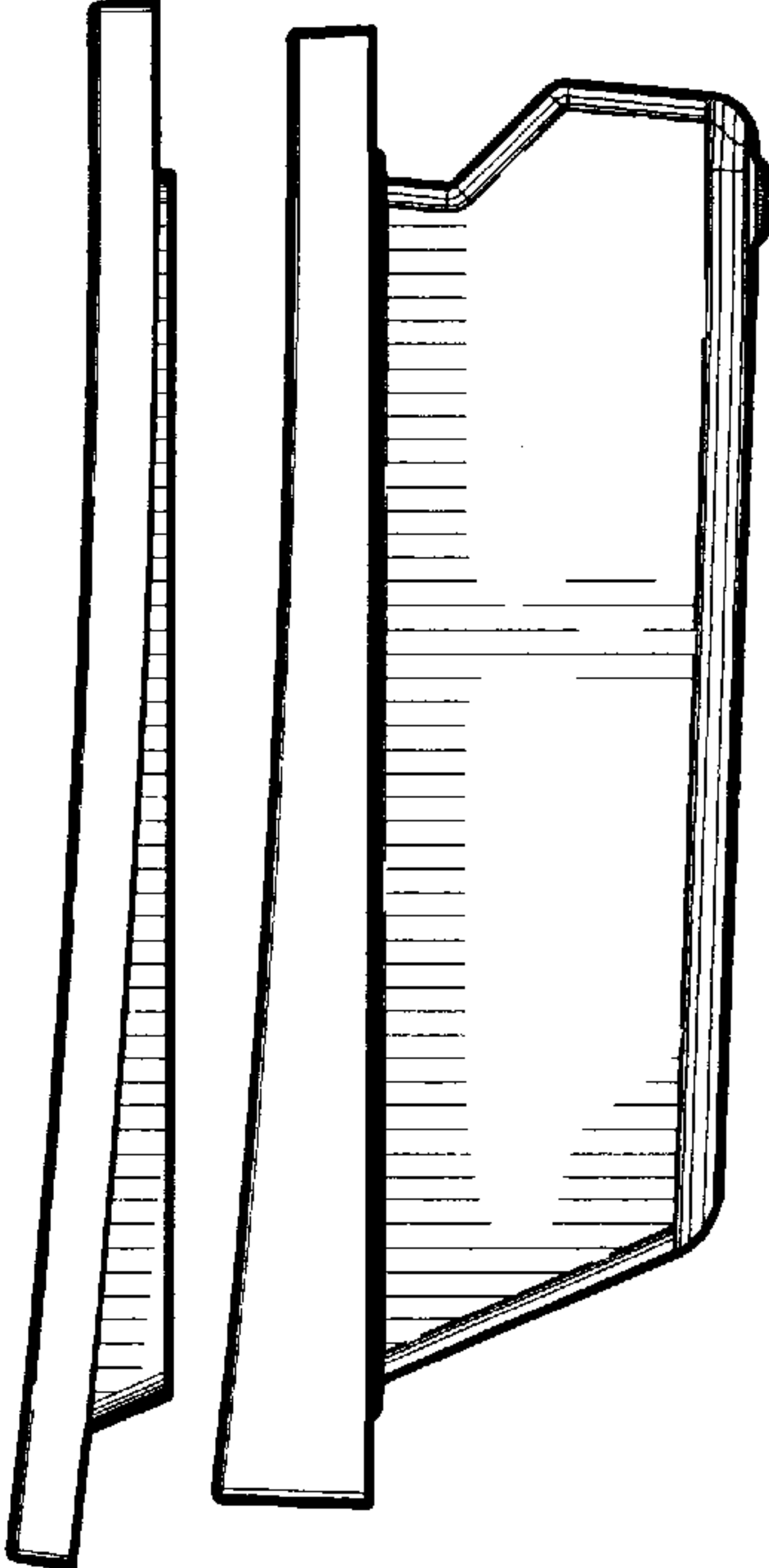

Fig. 9.

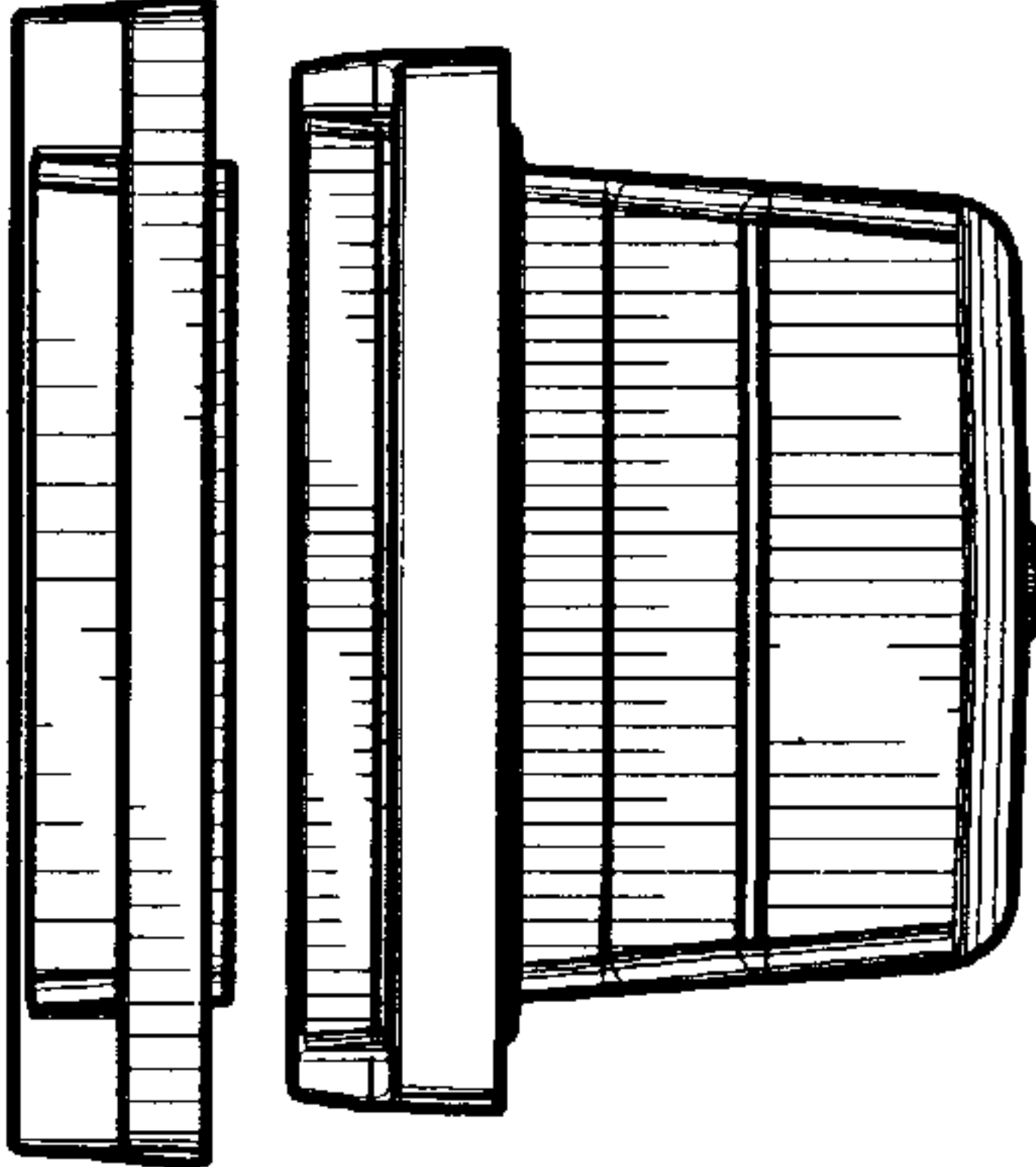

Fig. 10.