

US00D524920S

(12) **United States Design Patent**
Schaffeld et al.

(10) **Patent No.: US D524,920 S**

(45) **Date of Patent: ** Jul. 11, 2006**

(54) **FAUCET PULLOUT WAND**

(75) Inventors: **John Schaffeld**, Marshfield, MA (US);
Steffen Koury, Charlestown, MA (US)

(73) Assignee: **Masco Corporation of Indiana**,
Indianapolis, IN (US)

(**) Term: **14 Years**

(21) Appl. No.: **29/219,918**

(22) Filed: **Dec. 23, 2004**

(51) **LOC (8) Cl.** **23-01**

(52) **U.S. Cl.** **D23/255**

(58) **Field of Classification Search** D23/238-257,
D23/223; 4/675-678; 137/801
See application file for complete search history.

(56) **References Cited**

U.S. PATENT DOCUMENTS

D324,905 S	*	3/1992	Chretien	D23/238
D344,324 S	*	2/1994	Mattis	D23/238
D352,766 S	*	11/1994	Hill et al.	D23/213
D396,092 S	*	7/1998	Haug et al.	D23/238
D446,842 S	*	8/2001	Green et al.	D23/255

D467,636 S	*	12/2002	Boesch	D23/223
D484,948 S	*	1/2004	Green et al.	D23/238

* cited by examiner

Primary Examiner—Louis S. Zarfes

Assistant Examiner—Gregory Andoll

(74) *Attorney, Agent, or Firm*—Kwadjo Adusei-Poku;
Lloyd D. Doigan

(57) **CLAIM**

The ornamental design for a faucet pullout wand, as shown and described.

DESCRIPTION

FIG. 1 is a front perspective view of a faucet pullout wand showing my design;
FIG. 2 is a front elevational view thereof;
FIG. 3 is a rear elevational view thereof;
FIG. 4 is a right side elevational view, the left side elevational view being a mirror image thereof;
FIG. 5 is a top plan view thereof; and,
FIG. 6 is a rear perspective view thereof.
The broken lines in the Figures are for illustrative purposes only and form no part of the claimed design.

1 Claim, 6 Drawing Sheets

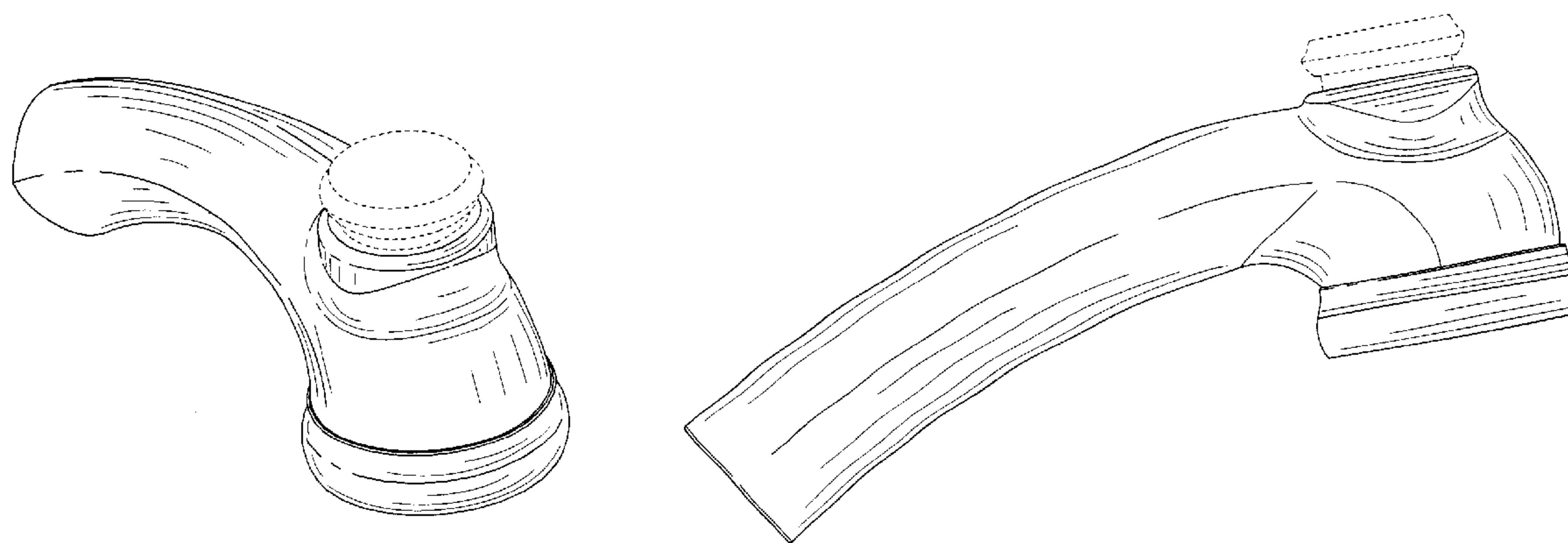

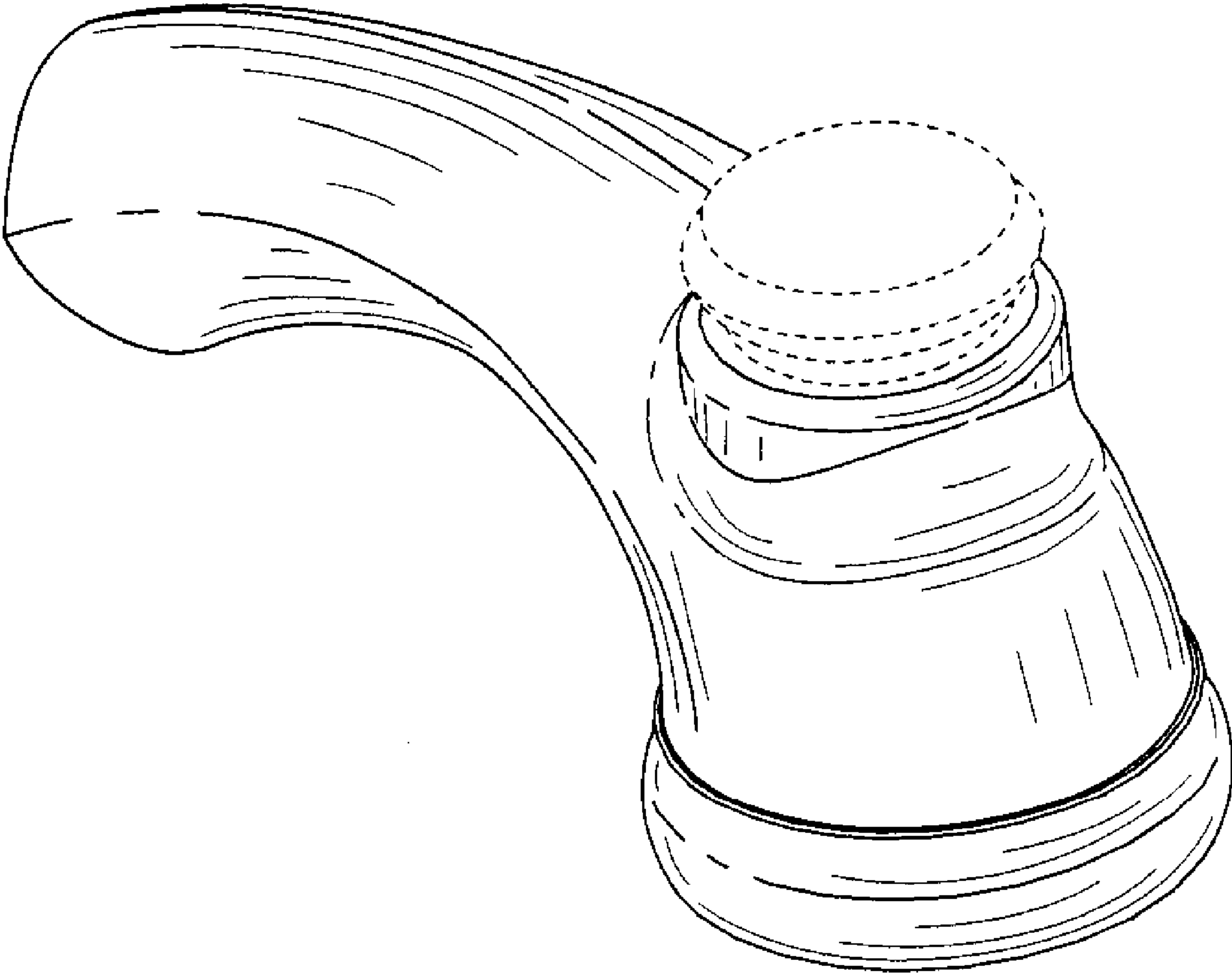

FIG. 1

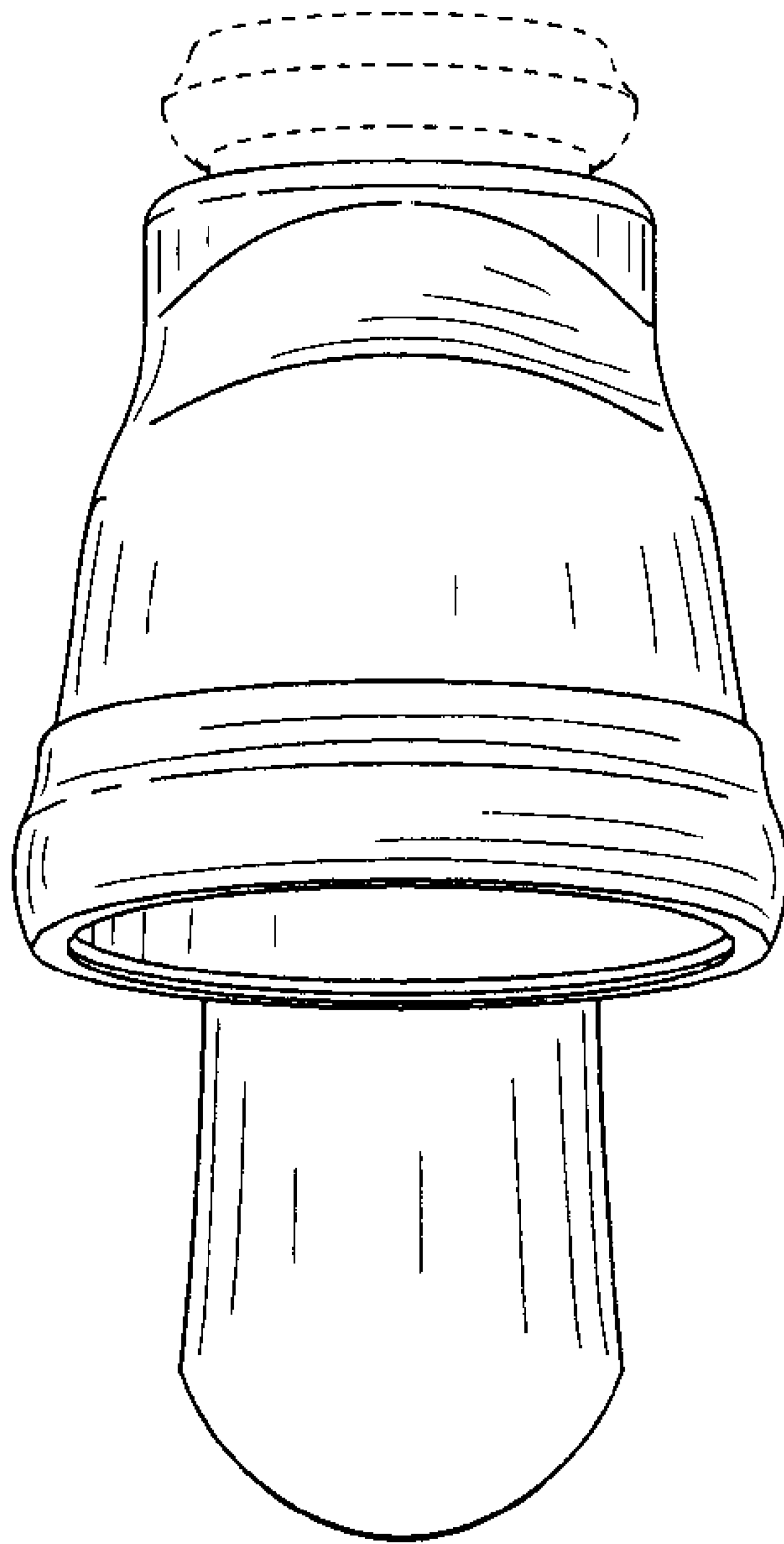

FIG. 2

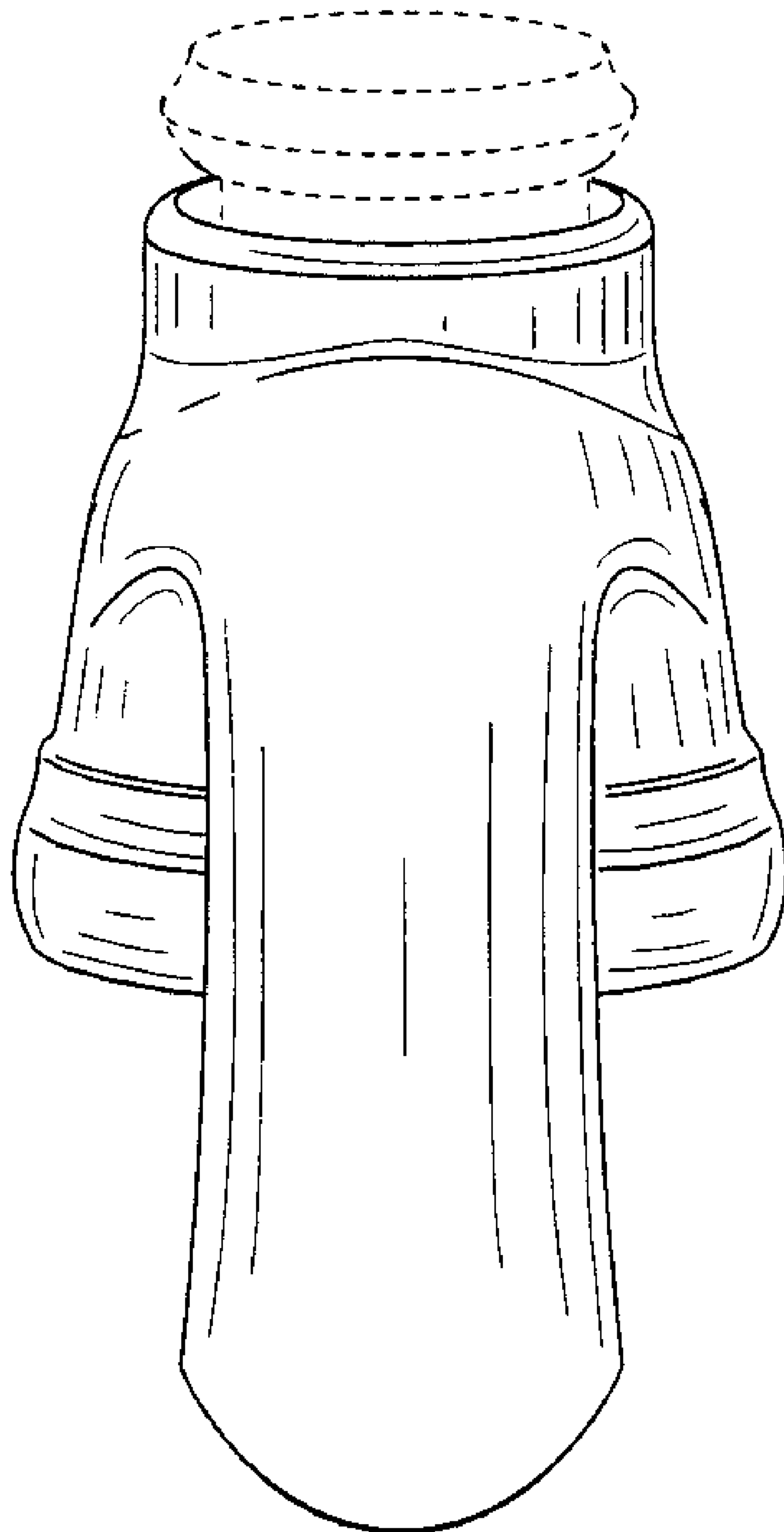

FIG. 3

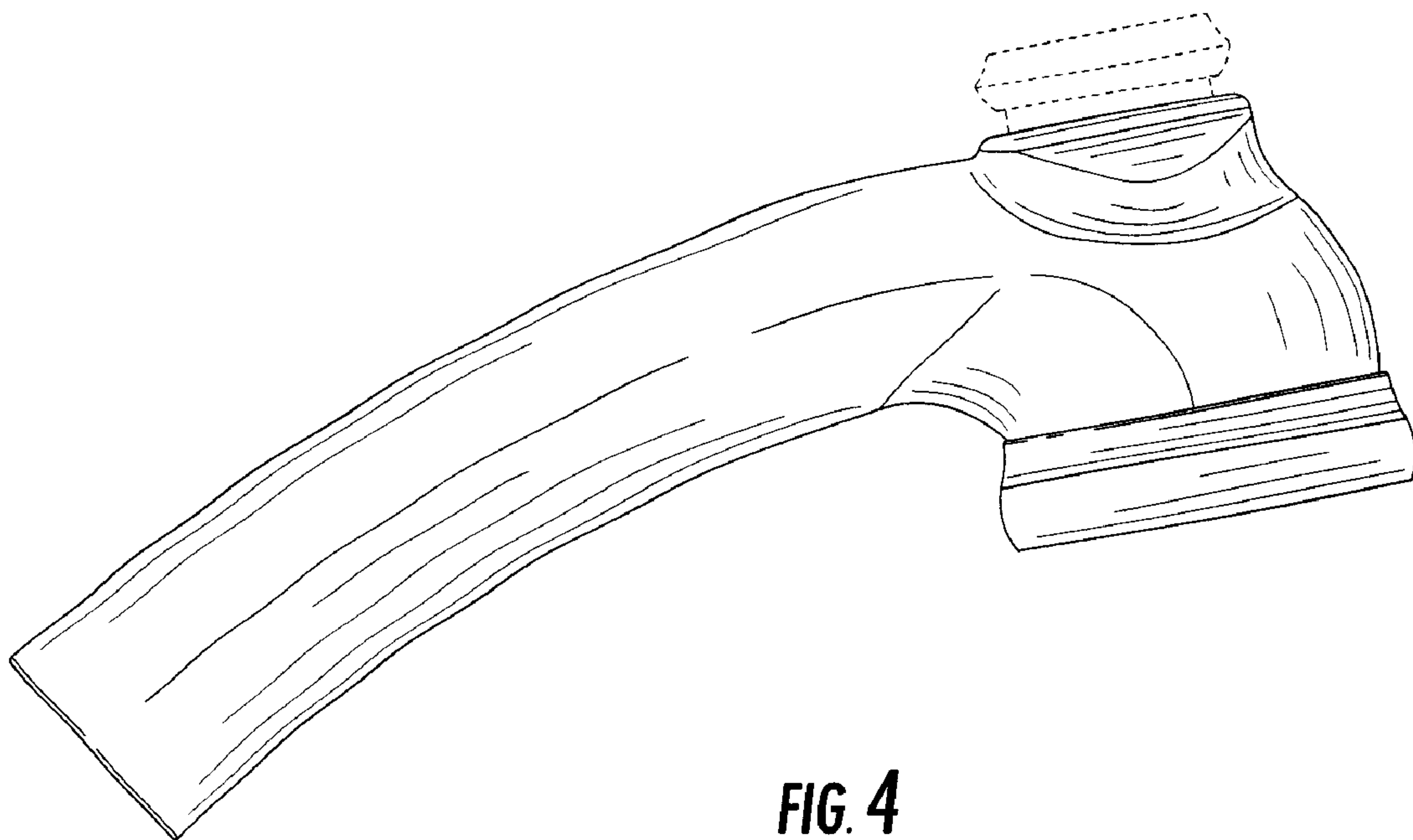

FIG. 4

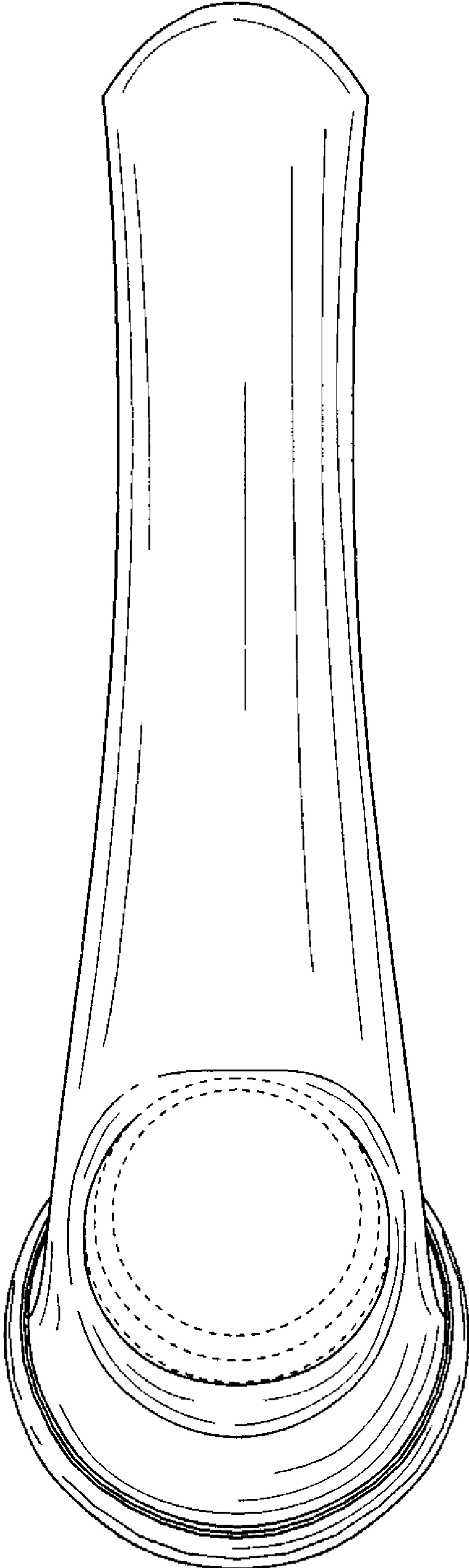

FIG. 5

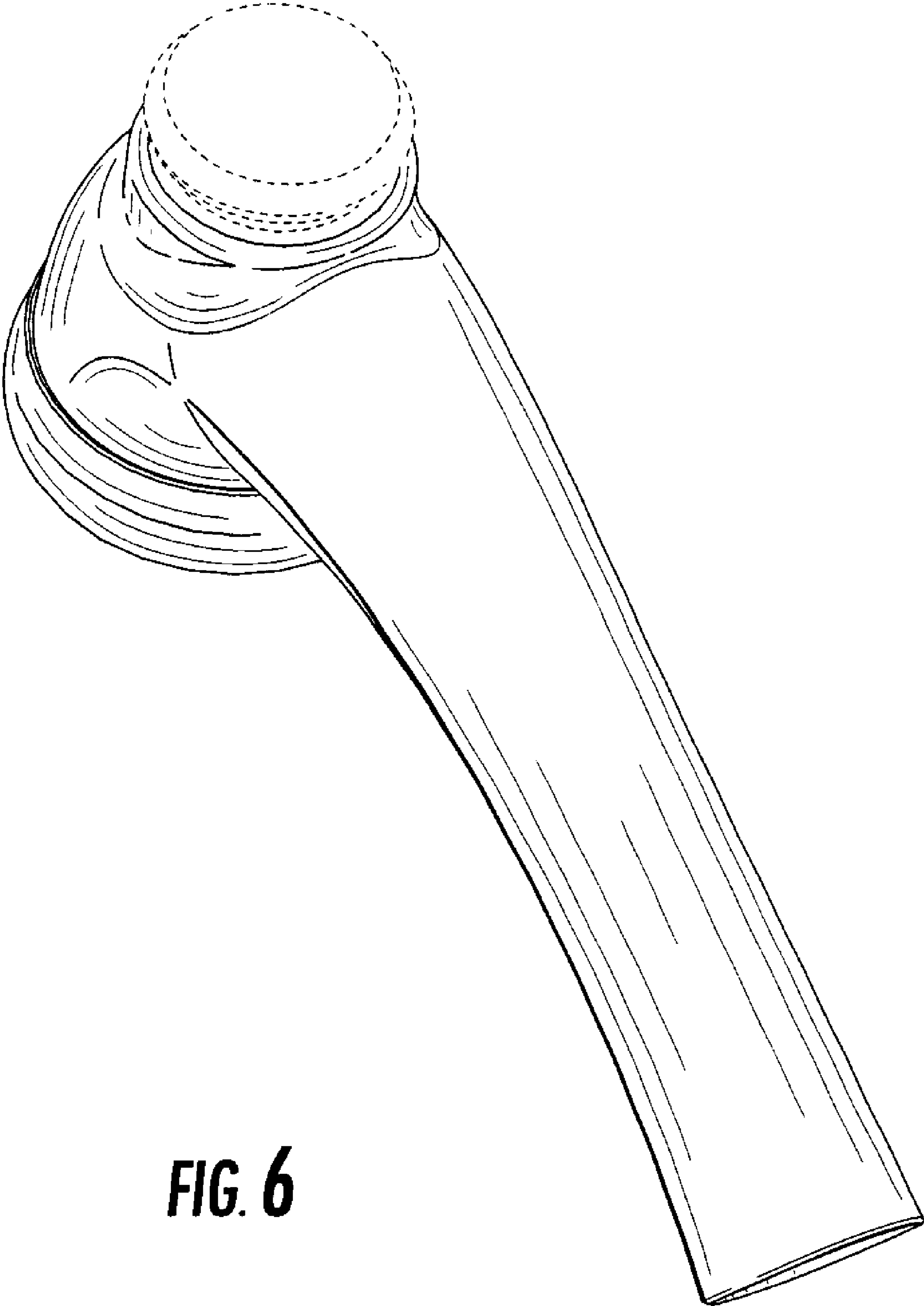

FIG. 6