

US00D524776S

(12) **United States Design Patent**  
**Chang**

(10) **Patent No.:** **US D524,776 S**  
(45) **Date of Patent:** **\*\* Jul. 11, 2006**

(54) **CELLULAR PHONE**

(75) Inventor: **In Won Chang**, Seoul (KR)

(73) Assignee: **LG Electronics Inc.**, Seoul (KR)

(\*\*) Term: **14 Years**

(21) Appl. No.: **29/194,443**

(22) Filed: **Nov. 25, 2003**

(30) **Foreign Application Priority Data**

May 26, 2003 (KR) ..... 30-2003-0014537

(51) **LOC (8) Cl.** ..... **14-03**

(52) **U.S. Cl.** ..... **D14/138**

(58) **Field of Classification Search** ..... D14/137,  
D14/138, 147-148, 247-248, 144, 341-347;  
379/433.01-433.13, 434; D21/517; 455/575.3,  
455/566, 575.1; 345/169

See application file for complete search history.

(56) **References Cited**

**U.S. PATENT DOCUMENTS**

5,485,517	A	*	1/1996	Gray	.....	379/433.13
D401,577	S	*	11/1998	Yamaguchi	.....	D14/138
D419,990	S	*	2/2000	Park	.....	D14/138
D427,172	S	*	6/2000	Bequir	.....	D14/138
D460,429	S	*	7/2002	Kolwaite	.....	D14/138
6,473,631	B1	*	10/2002	Siddoway et al.	.....	455/575.1
6,549,789	B1	*	4/2003	Kfoury	.....	455/550.1
6,628,508	B1	*	9/2003	Lieu et al.	.....	361/680
D480,697	S	*	10/2003	Lee et al.	.....	D14/138
D486,464	S	*	2/2004	Lee	.....	D14/138
6,697,117	B1	*	2/2004	Park	.....	348/373
D487,733	S	*	3/2004	Lucaci et al.	.....	D14/138
D495,675	S	*	9/2004	Nuovo et al.	.....	D14/144
D496,019	S	*	9/2004	Okada et al.	.....	D14/138
D496,020	S	*	9/2004	Lee	.....	D14/138
D496,644	S	*	9/2004	Yoo et al.	.....	D14/138
6,850,784	B1	*	2/2005	SanGiovanni	.....	455/575.1
D506,739	S	*	6/2005	Shin et al.	.....	D14/138
D508,903	S	*	8/2005	Kim et al.	.....	D14/138
D509,815	S	*	9/2005	Jang	.....	D14/138
D510,080	S	*	9/2005	Kim et al.	.....	D14/138

2003/0064758	A1	*	4/2003	Mizuta et al.	.....	455/566
2003/0078069	A1	*	4/2003	Lindeman	.....	455/550
2003/0124991	A1	*	7/2003	Kiuchi et al.	.....	455/90
2004/0048632	A1	*	3/2004	Kuroda	.....	455/550.1
2004/0121825	A1	*	6/2004	Ma et al.	.....	455/575.4
2004/0127262	A1	*	7/2004	Ohno	.....	455/566
2004/0132482	A1	*	7/2004	Kang et al.	.....	455/550.1
2004/0192422	A1	*	9/2004	Watanabe et al.	.....	455/575.3
2004/0198476	A1	*	10/2004	Aikawa et al.	.....	455/575.3
2004/0203535	A1	*	10/2004	Kim et al.	.....	455/90.3
2004/0219956	A1	*	11/2004	Iwai et al.	.....	455/575.3

**FOREIGN PATENT DOCUMENTS**

JP	1143093	*	6/2002
JP	1159728	*	12/2002
JP	1174585	*	6/2003

\* cited by examiner

*Primary Examiner*—Jeffrey Asch

(74) *Attorney, Agent, or Firm*—Birch Stewart Kolasch & Birch LLP

(57) **CLAIM**

The ornamental design for a cellular phone, substantially as shown and described.

**DESCRIPTION**

FIG. 1 is a perspective view of the cellular phone showing my new design;  
 FIG. 2 is a front view thereof;  
 FIG. 3 is a rear view thereof;  
 FIG. 4 is a left side view thereof;  
 FIG. 5 is a right side view thereof;  
 FIG. 6 is a top view thereof;  
 FIG. 7 is a bottom view thereof;  
 FIGS. 8 and 9 are right side views showing the rotated status of the front folder in an opened position;  
 FIG. 10-13 are front views showing the front folder rotated at various angles while in a closed position; and,  
 FIG. 14 is a front view thereof in an opened position.  
 The broken line showings of portions of the cell phone in the views are for illustrative purposes only and form no part of the claimed design.

**1 Claim, 10 Drawing Sheets**

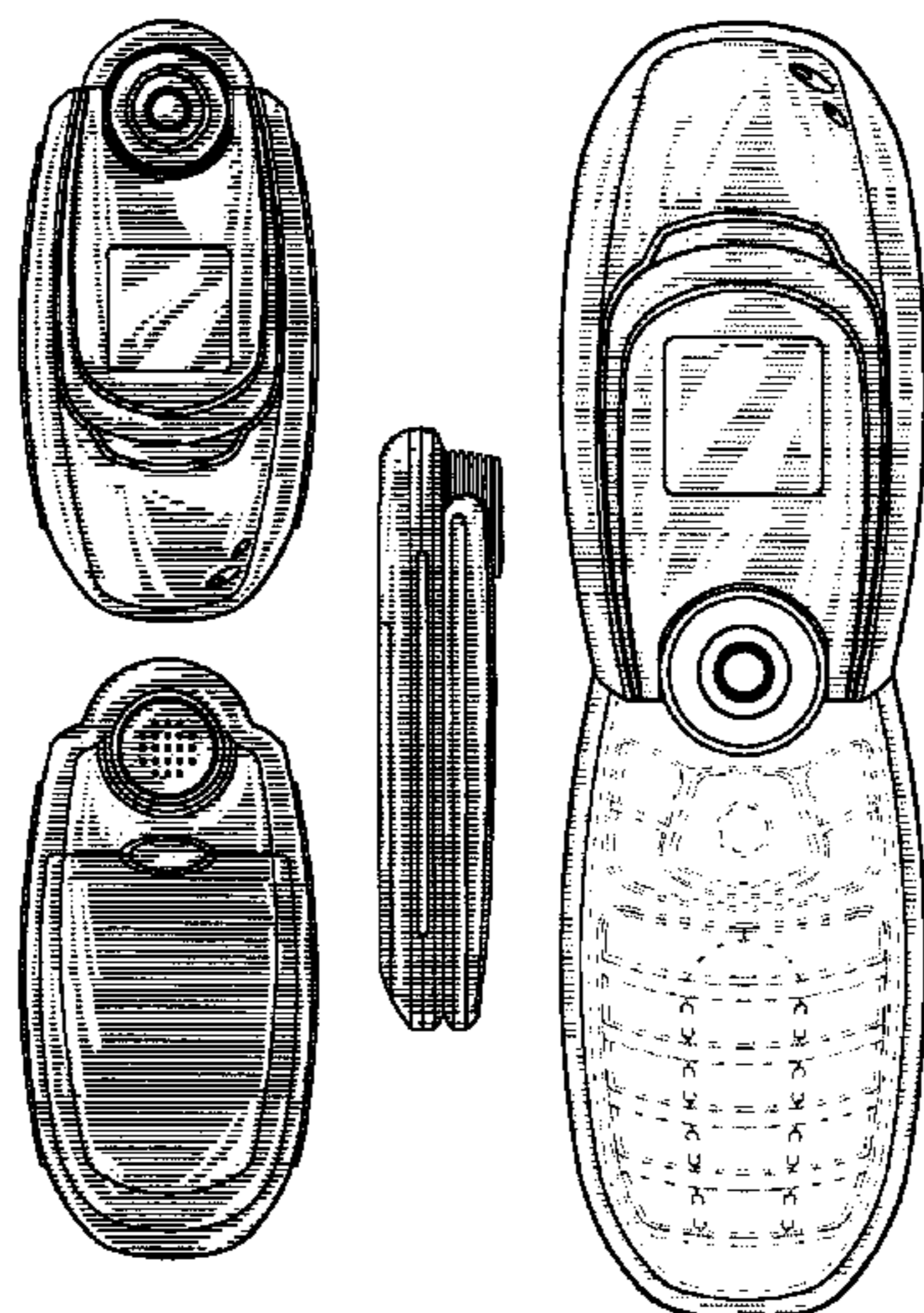

FIG. 1

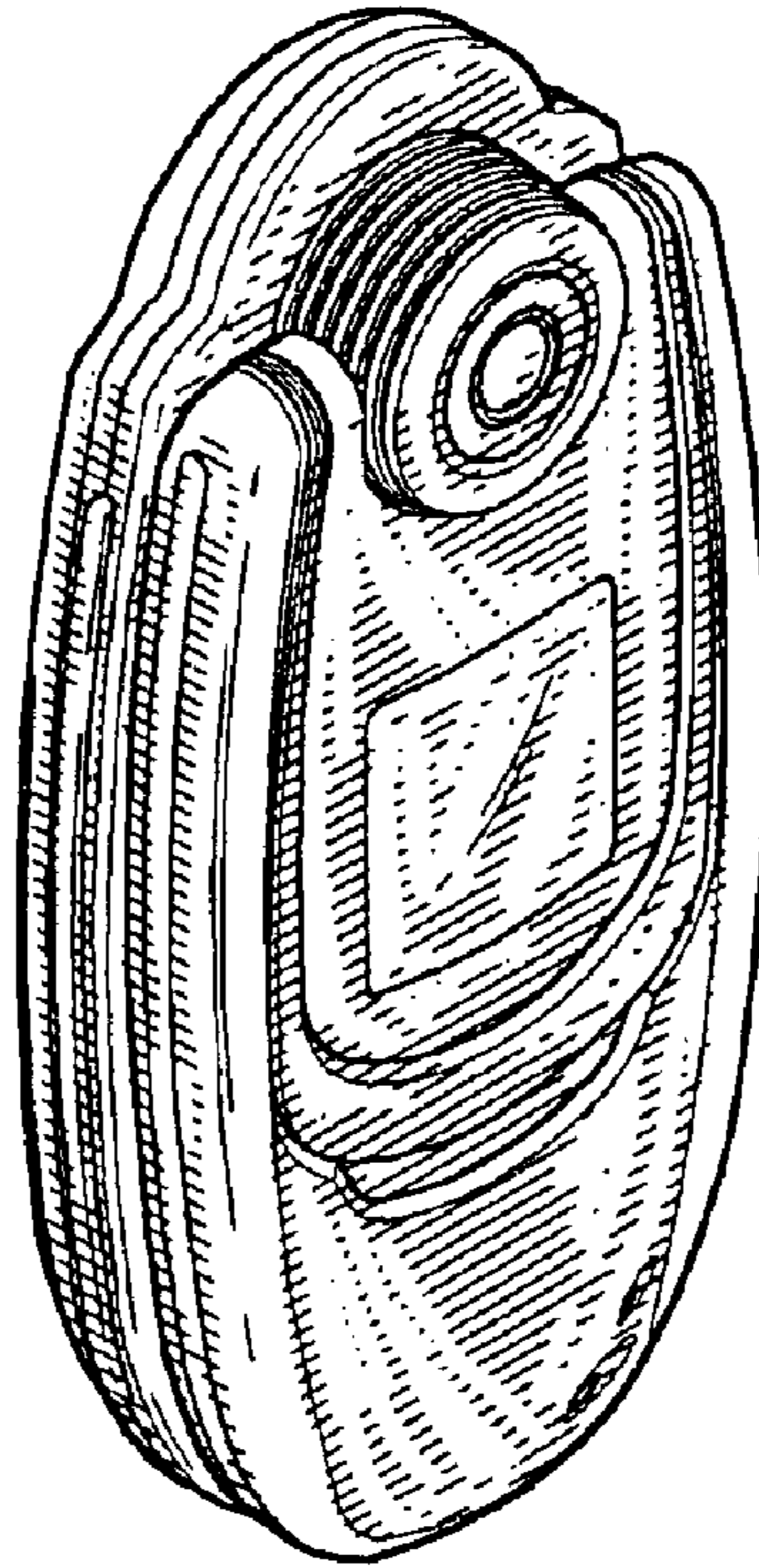

FIG. 2

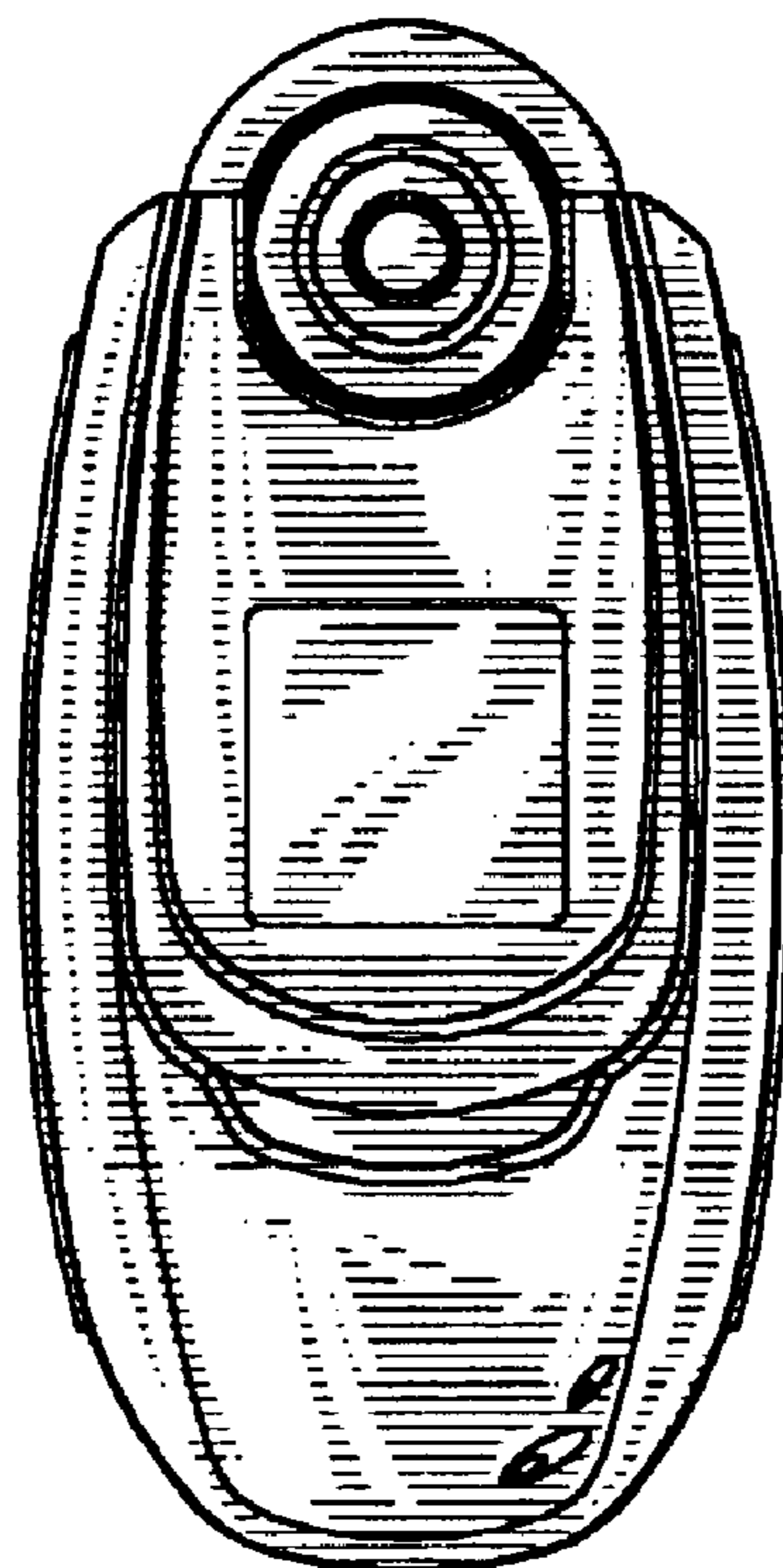

FIG. 3

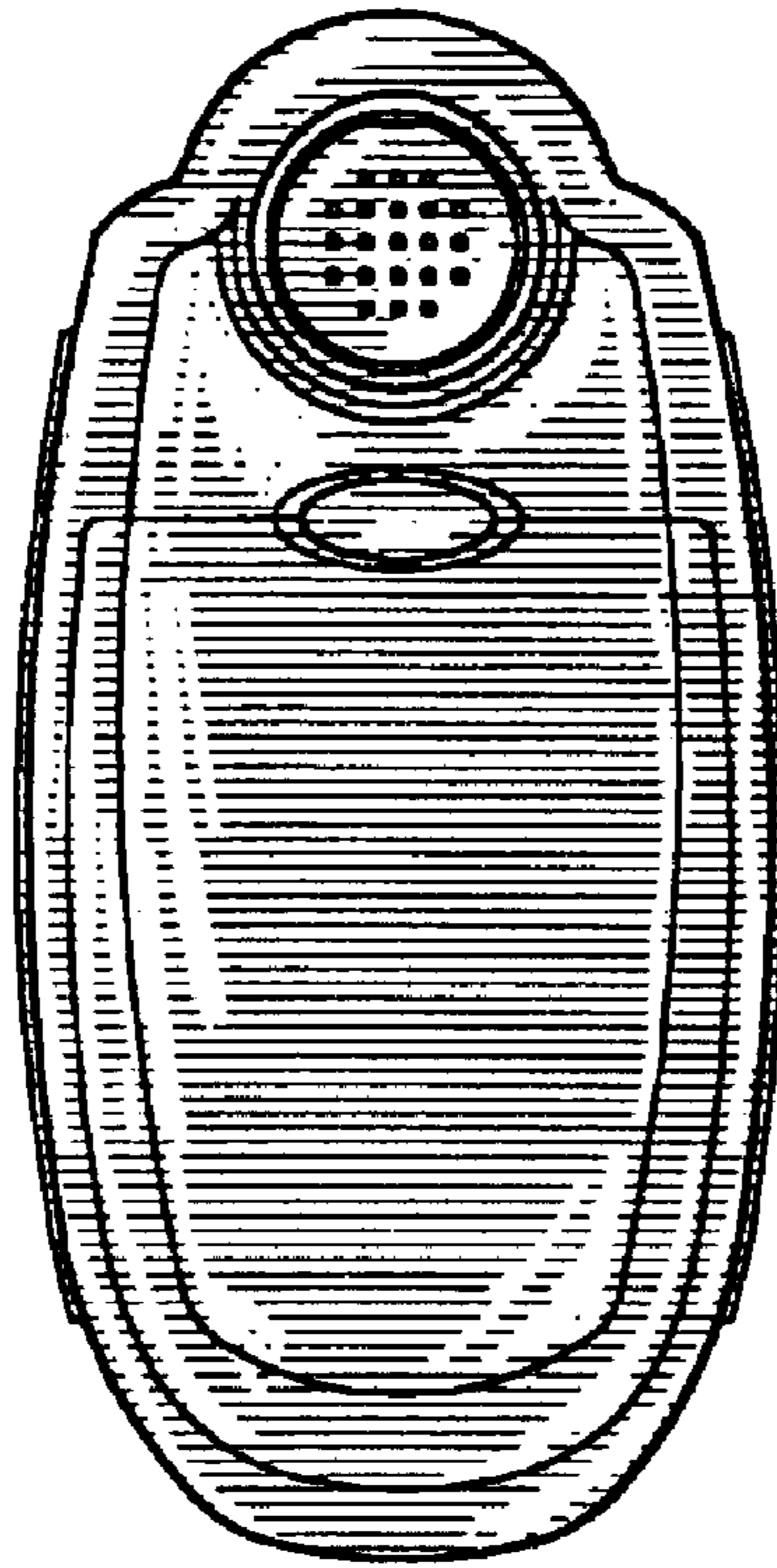

FIG. 4

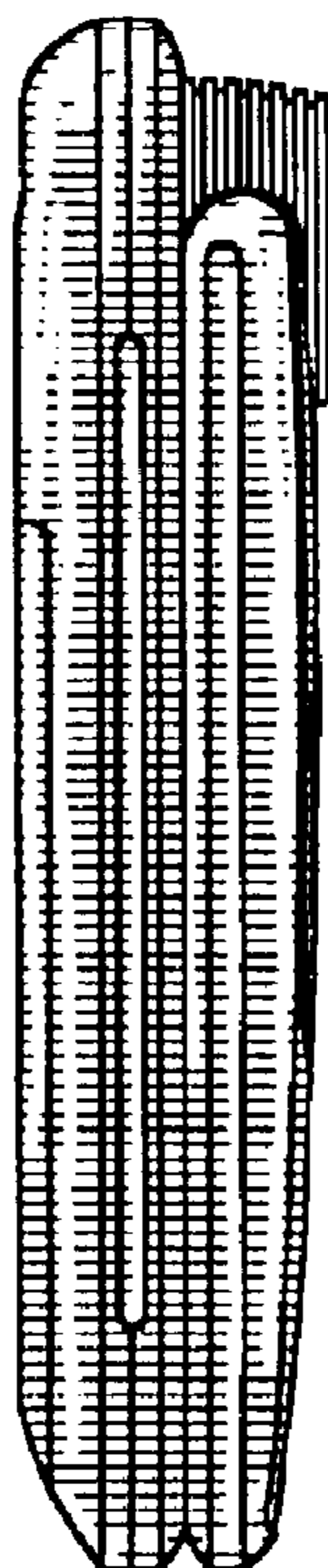

FIG. 5

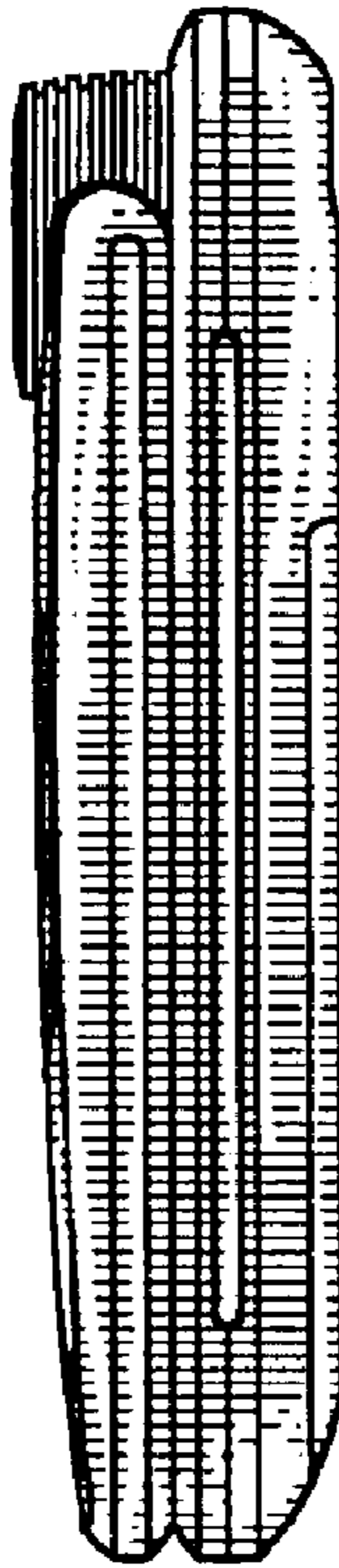

FIG. 6

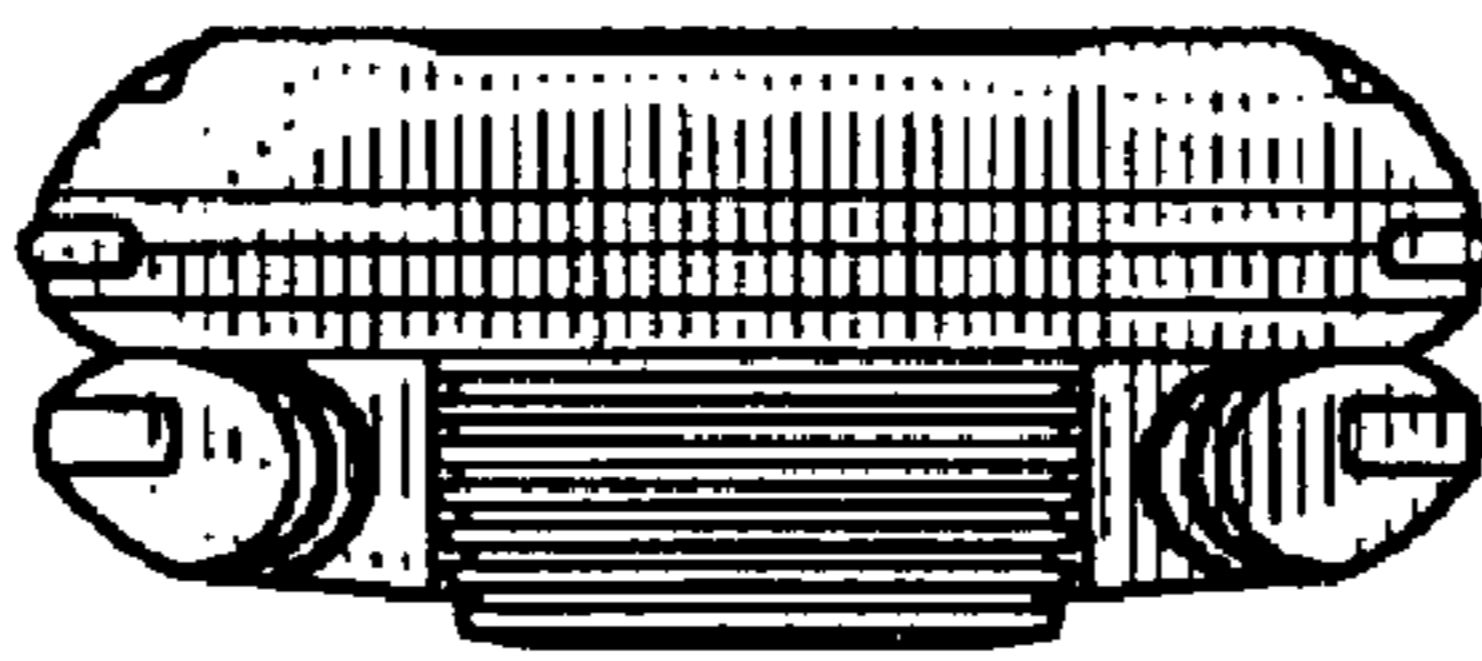

FIG. 7

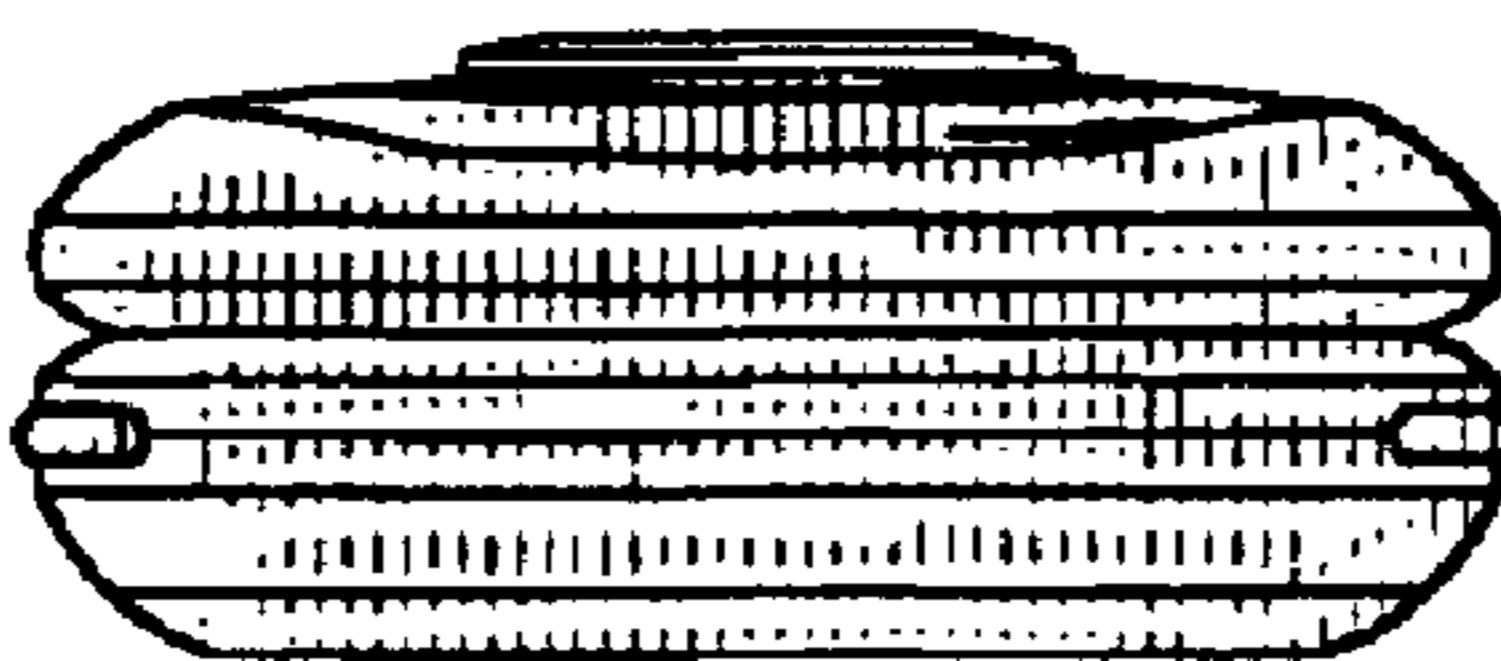

FIG. 8

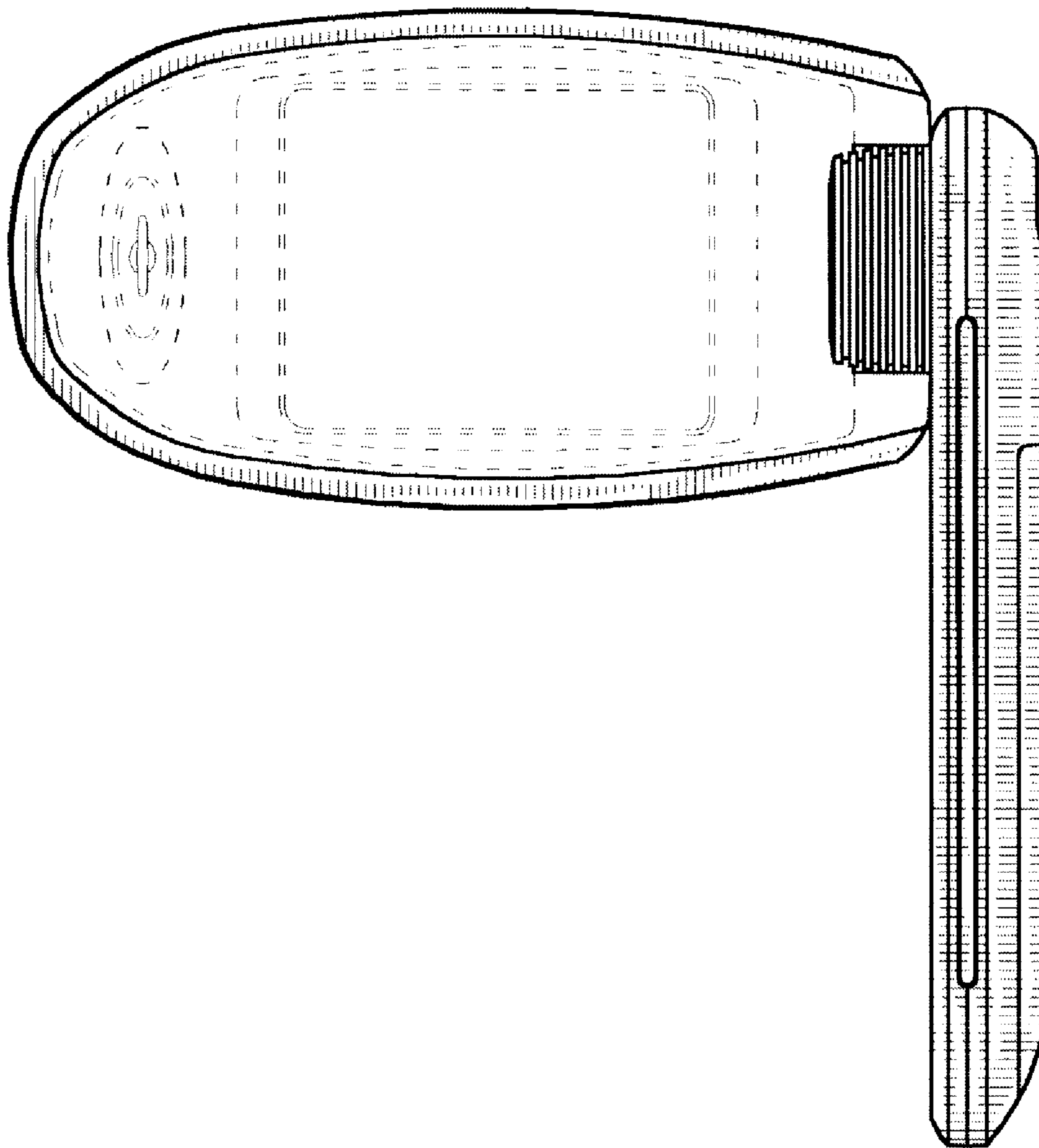

FIG. 9

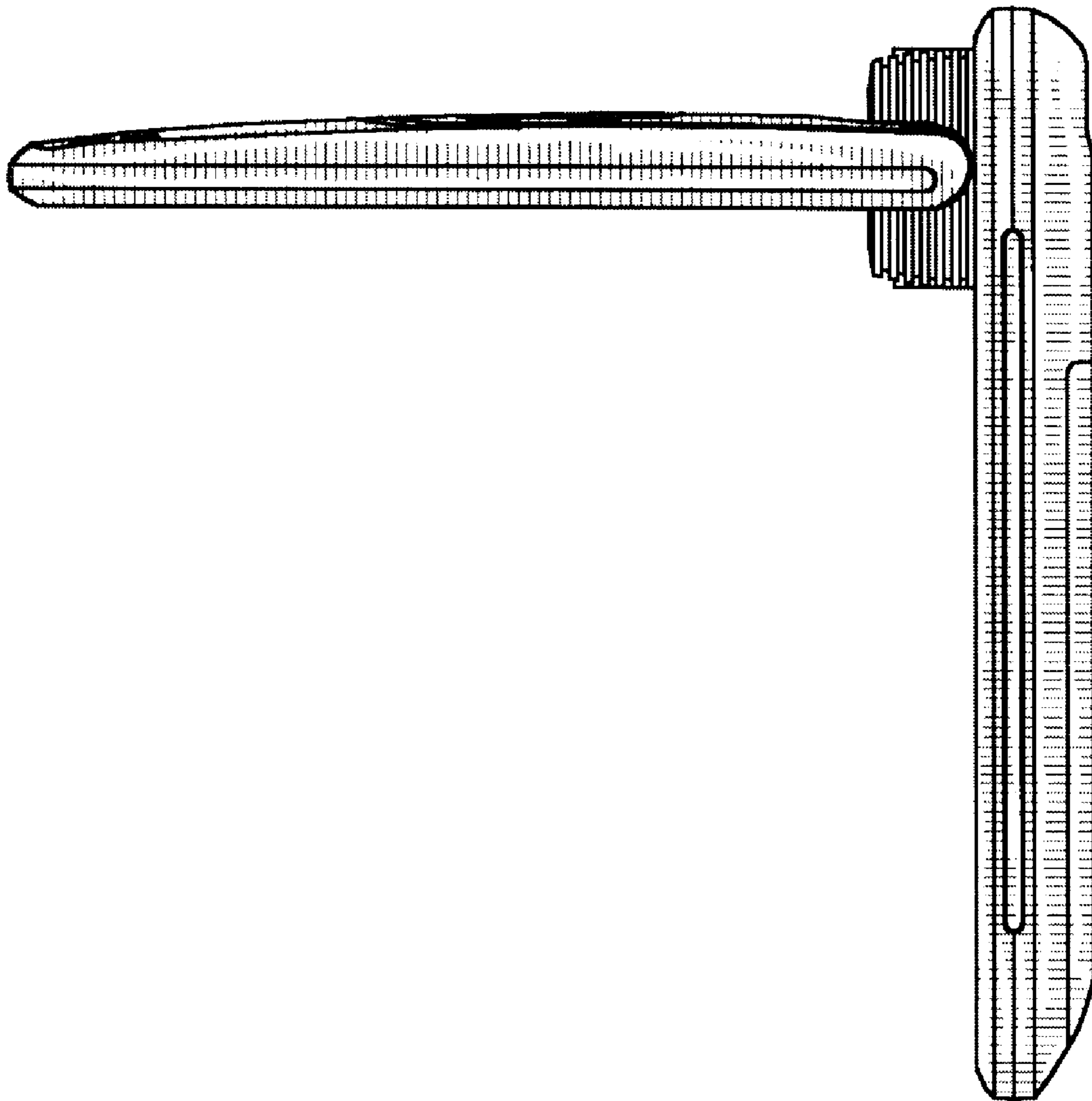

FIG. 10

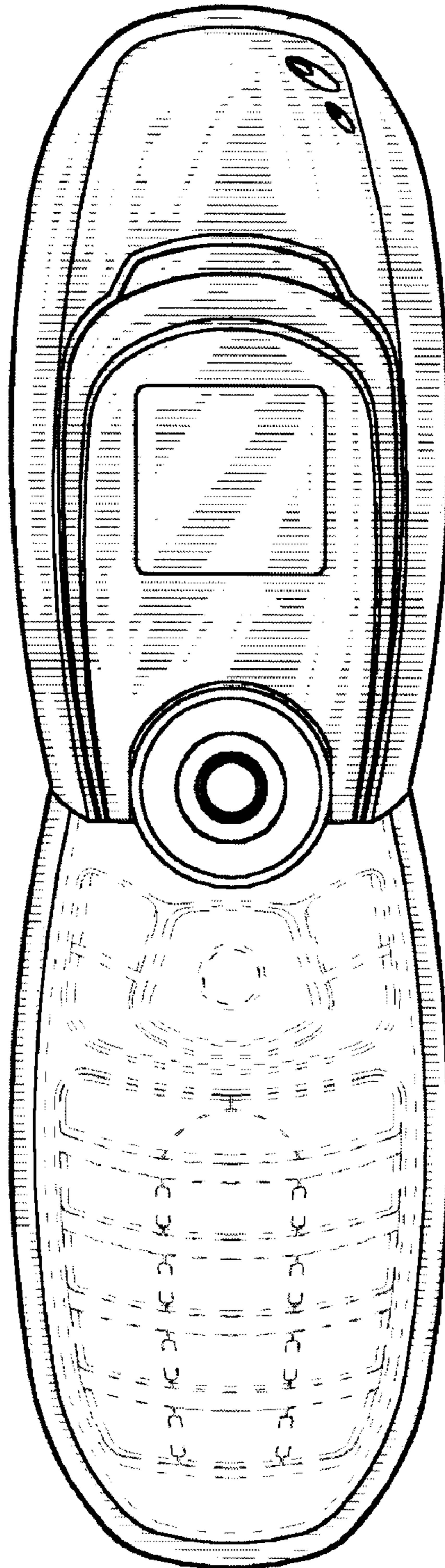

FIG. 11

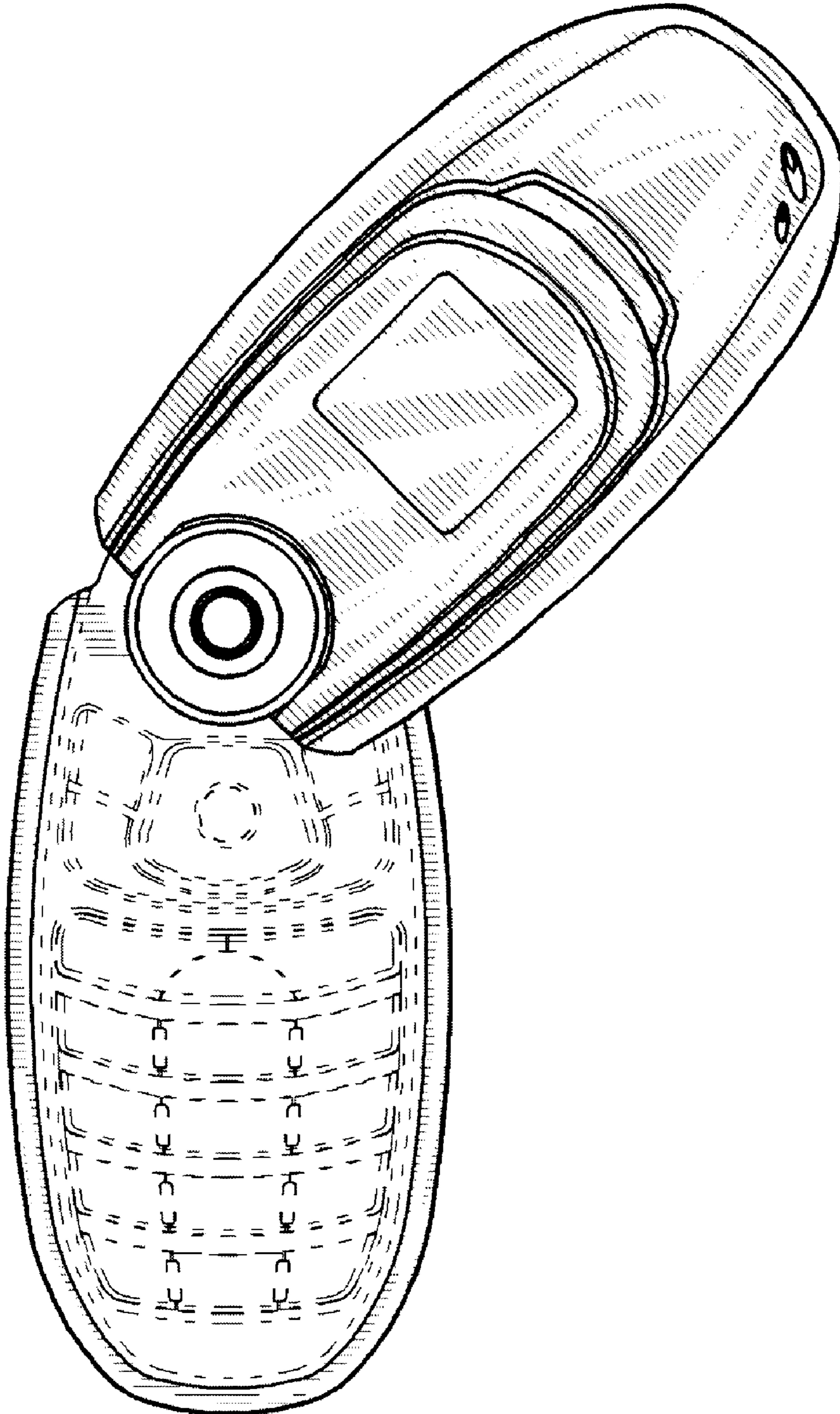



FIG. 12

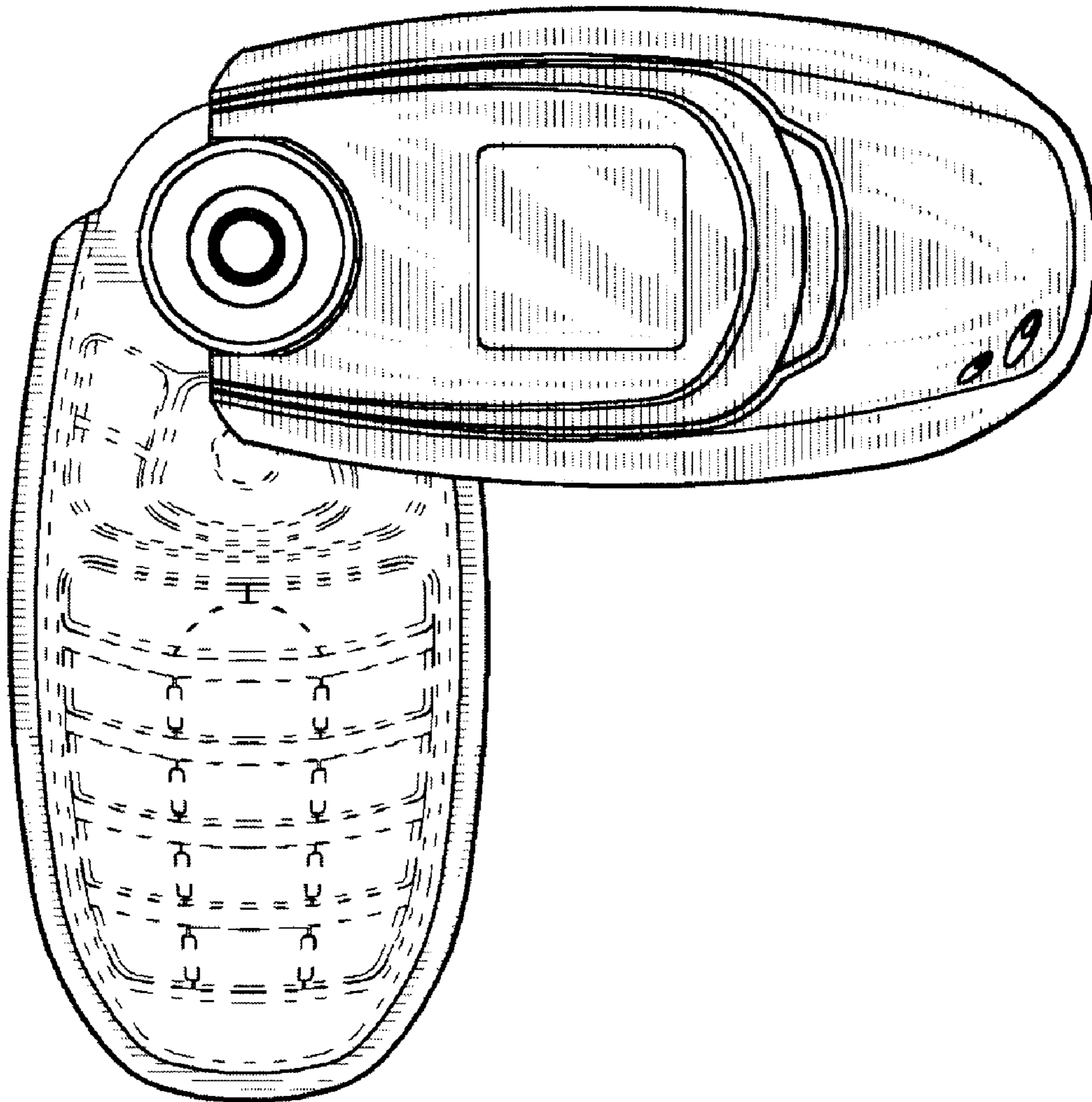

FIG. 13

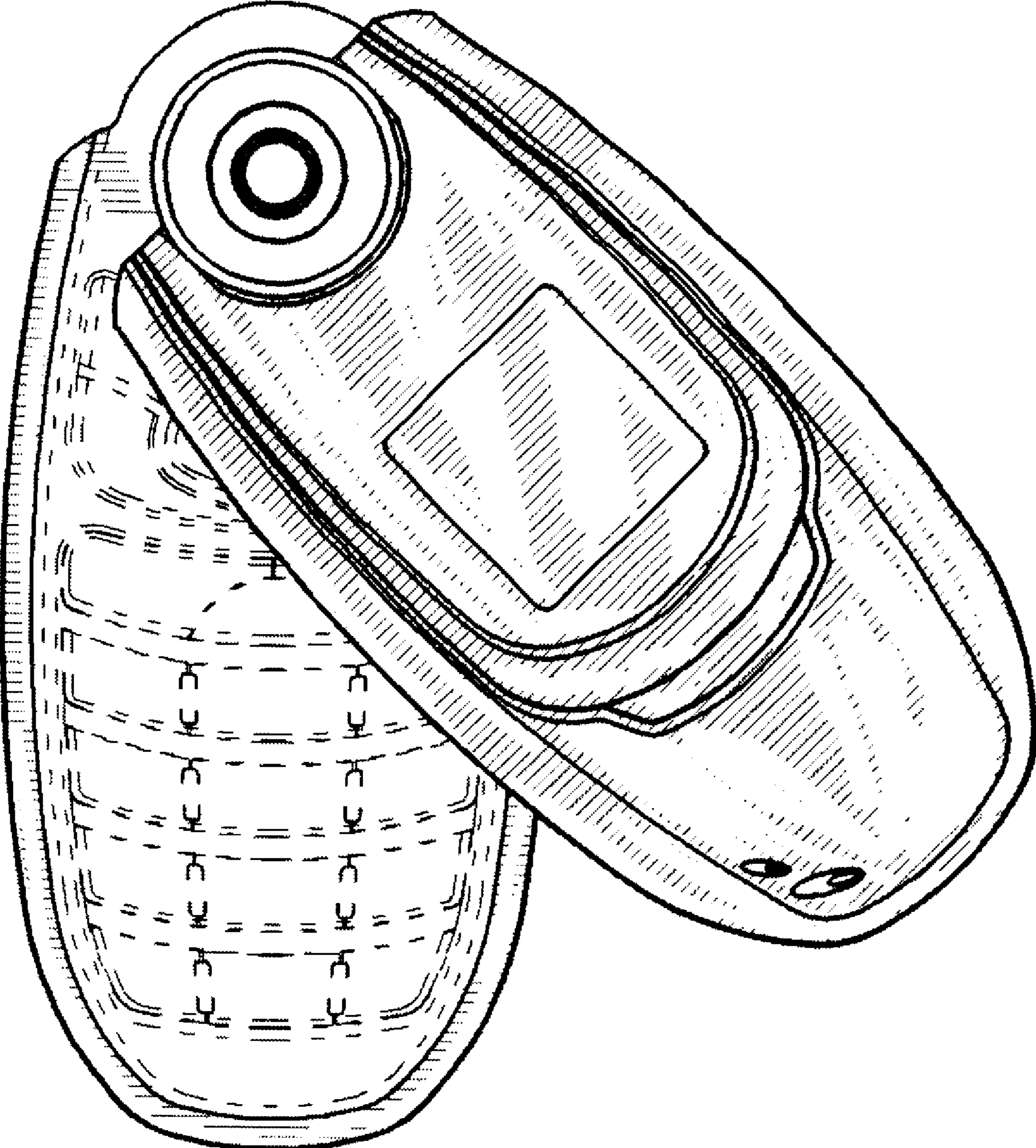

FIG. 14

