



US00D524747S

(12) **United States Design Patent**
Nishio et al.

(10) **Patent No.:** **US D524,747 S**

(45) **Date of Patent:** **** Jul. 11, 2006**

(54) **CONNECTOR**

(75) Inventors: **Atsushi Nishio**, Tama (JP); **Yoshinori Ohta**, Tama (JP); **Yasuhiko Shinohara**, Tama (JP)

(73) Assignee: **Mitsumi Electric Co., Ltd.**, Tokyo (JP)

(**) Term: **14 Years**

(21) Appl. No.: **29/223,247**

(22) Filed: **Feb. 14, 2005**

(30) **Foreign Application Priority Data**

Nov. 15, 2004 (JP) 2004-034783

(51) **LOC (8) Cl.** **13-03**

(52) **U.S. Cl.** **D13/147**

(58) **Field of Classification Search** D13/133,
D13/146-147, 154, 199; 439/79, 83, 108,
439/181, 607-610, 639

See application file for complete search history.

(56) **References Cited**

U.S. PATENT DOCUMENTS

5,338,227 A * 8/1994 Nakamura 439/607

6,193,825 B1 * 2/2001 Dolan 439/607

6,293,825 B1 * 9/2001 Huang 439/607

D461,454 S * 8/2002 Hagiwara D13/147

D462,326 S * 9/2002 Okamoto D13/147

D462,663 S * 9/2002 Hagiwara D13/147

D478,050 S * 8/2003 Nishio et al. D13/147

D478,320 S * 8/2003 Suzuki et al. D13/147

D481,681 S * 11/2003 Takahashi D13/147

D482,658 S * 11/2003 Shao D13/147

D509,799 S * 9/2005 Tsai D13/147

* cited by examiner

Primary Examiner—Prabhakar Deshmukh

Assistant Examiner—Daniel Bui

(74) *Attorney, Agent, or Firm*—Sughrue Mion, PLLC

(57) **CLAIM**

The ornamental design for a connector, as shown.

DESCRIPTION

FIG. 1 is a perspective view of the top, front, and right side of a connector showing our new design;

FIG. 2 is a top plan view thereof;

FIG. 3 is a front elevational view thereof;

FIG. 4 is a right side elevational view thereof;

FIG. 5 is a left side elevational view thereof;

FIG. 6 is a rear elevational view thereof; and,

FIG. 7 is a bottom plan view thereof.

1 Claim, 4 Drawing Sheets

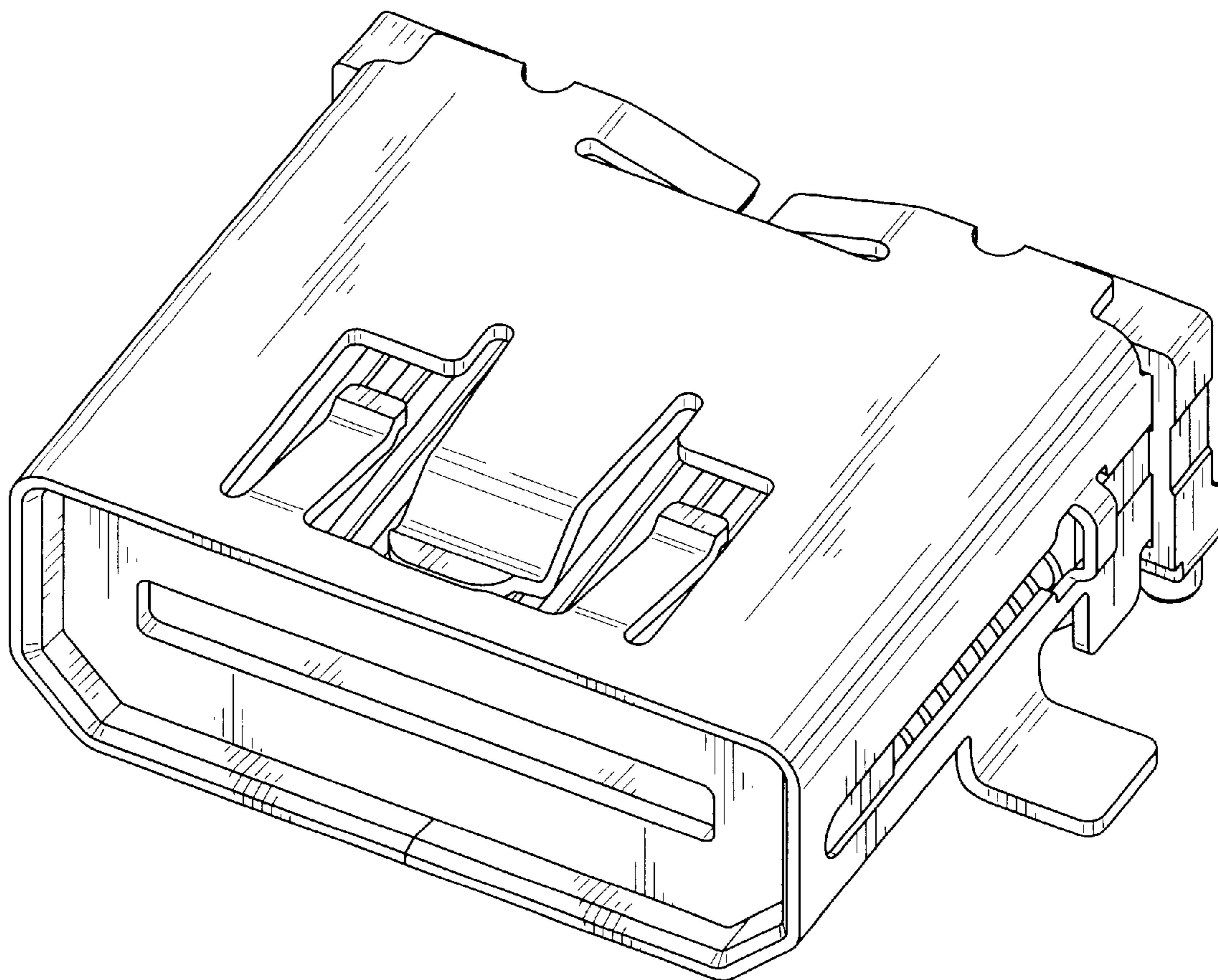

FIG. 1

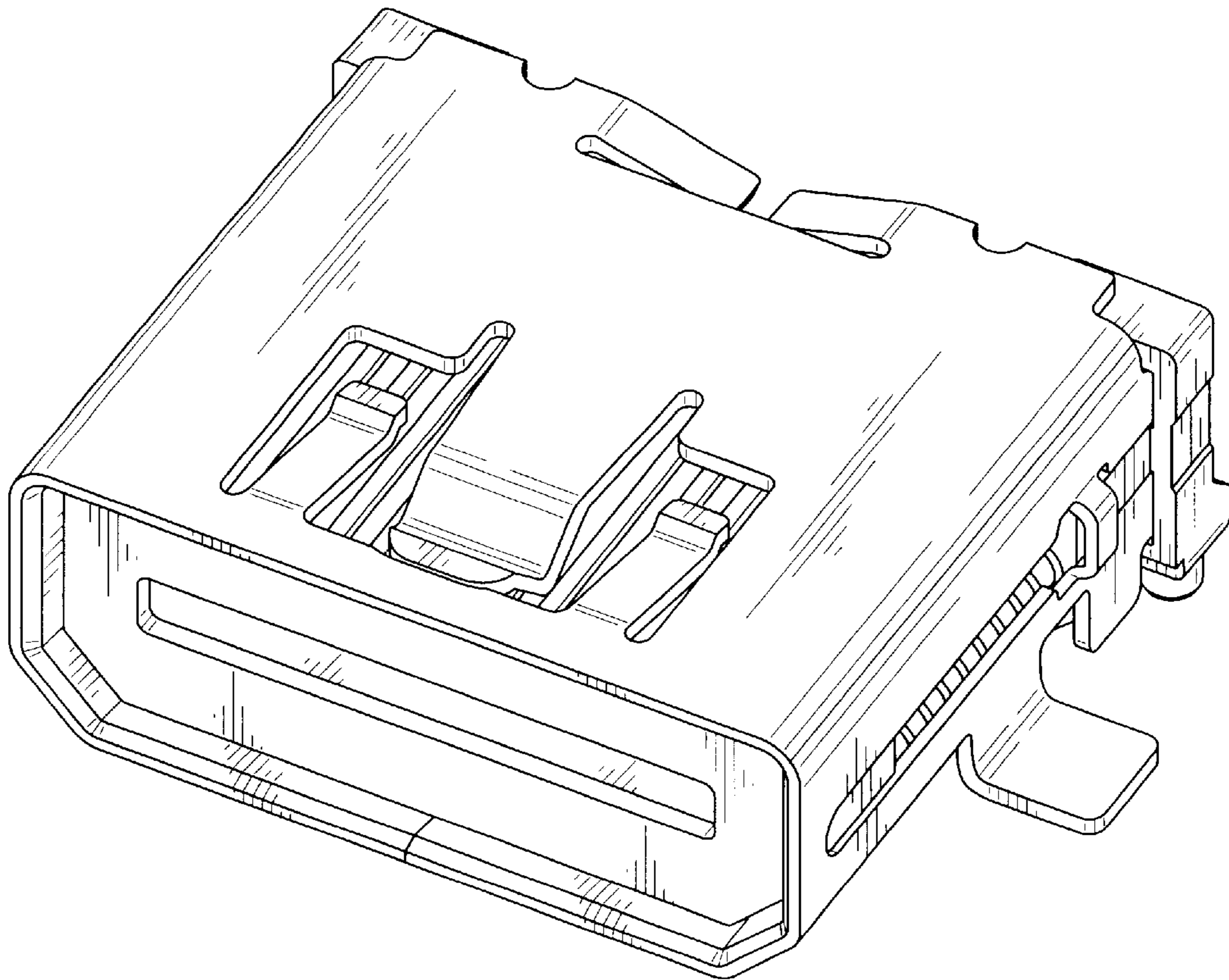

FIG. 2

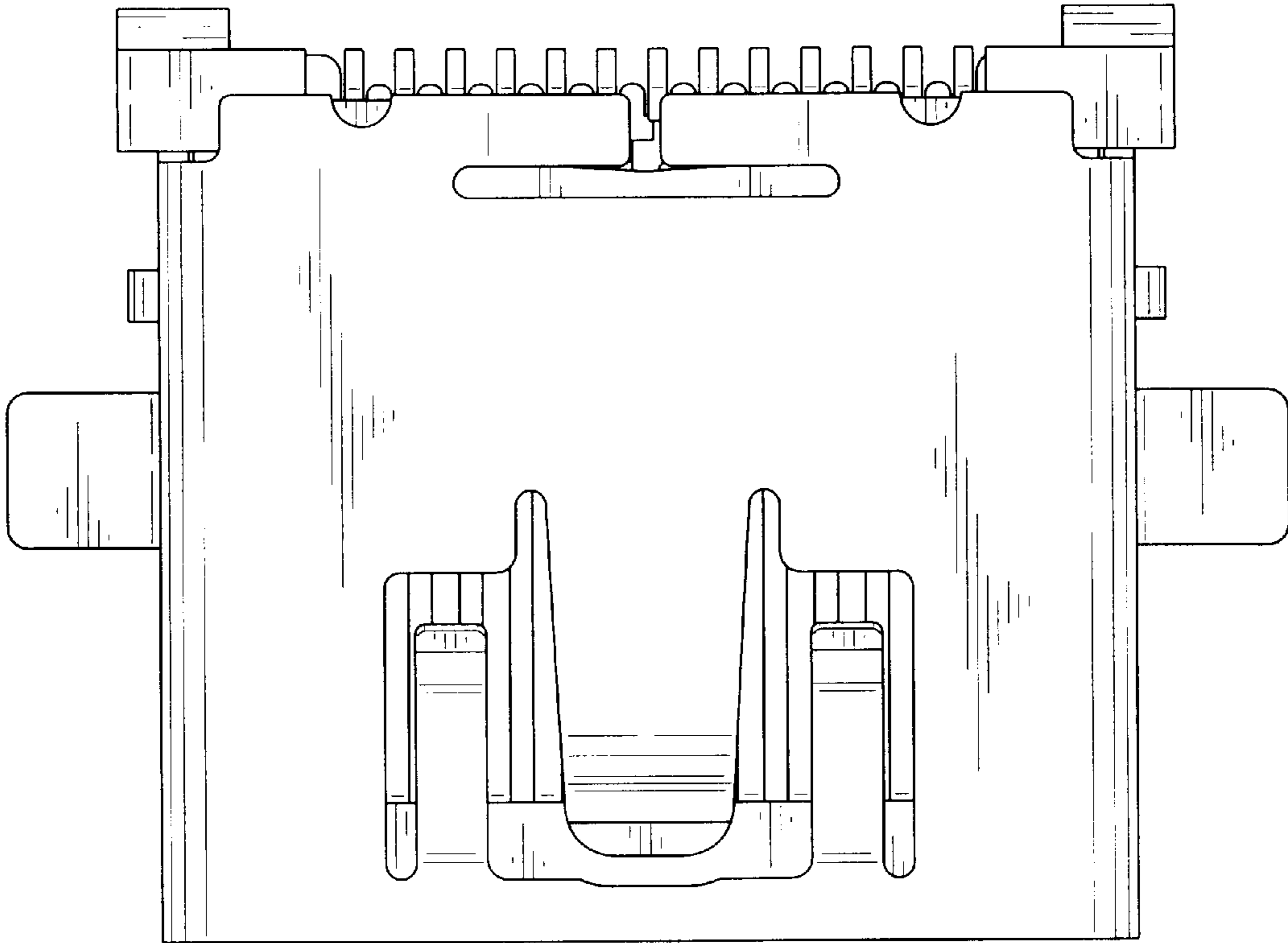

FIG. 3

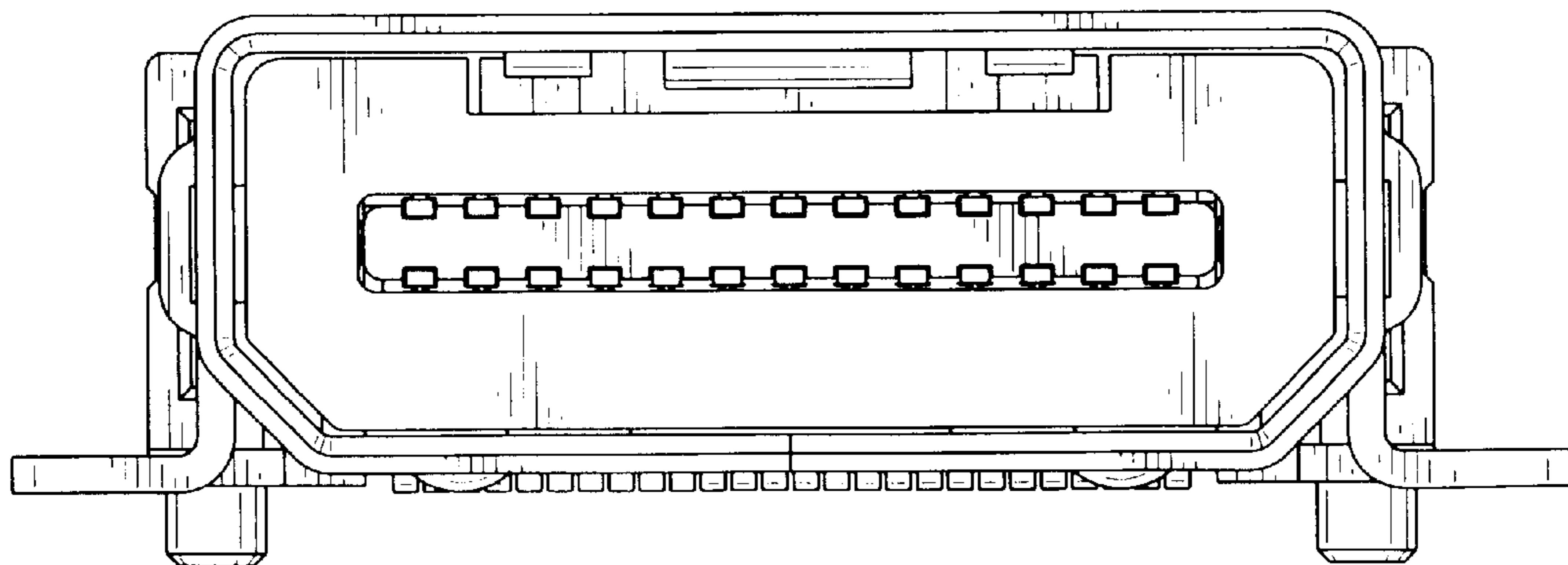

FIG. 4

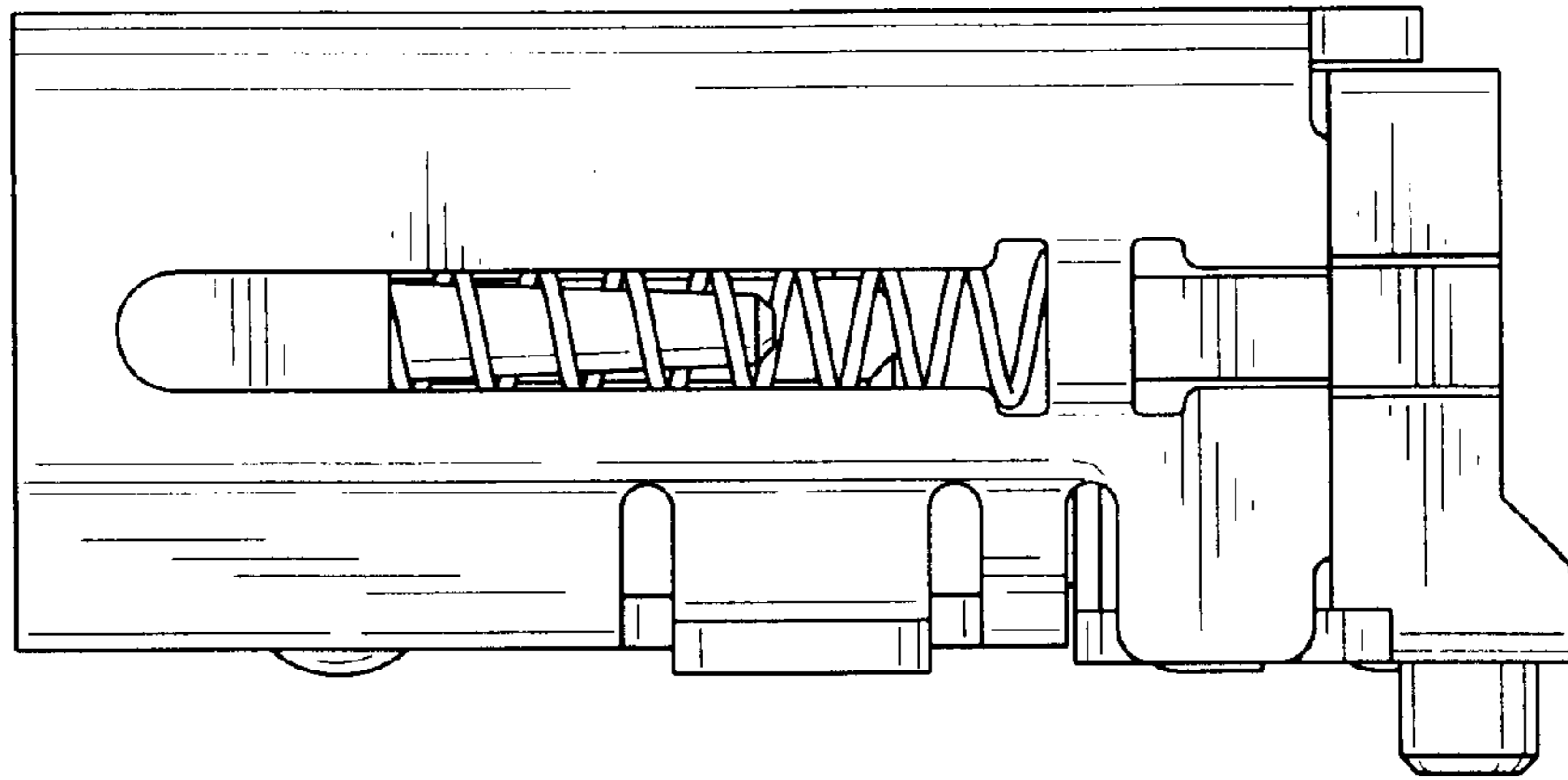

FIG. 5

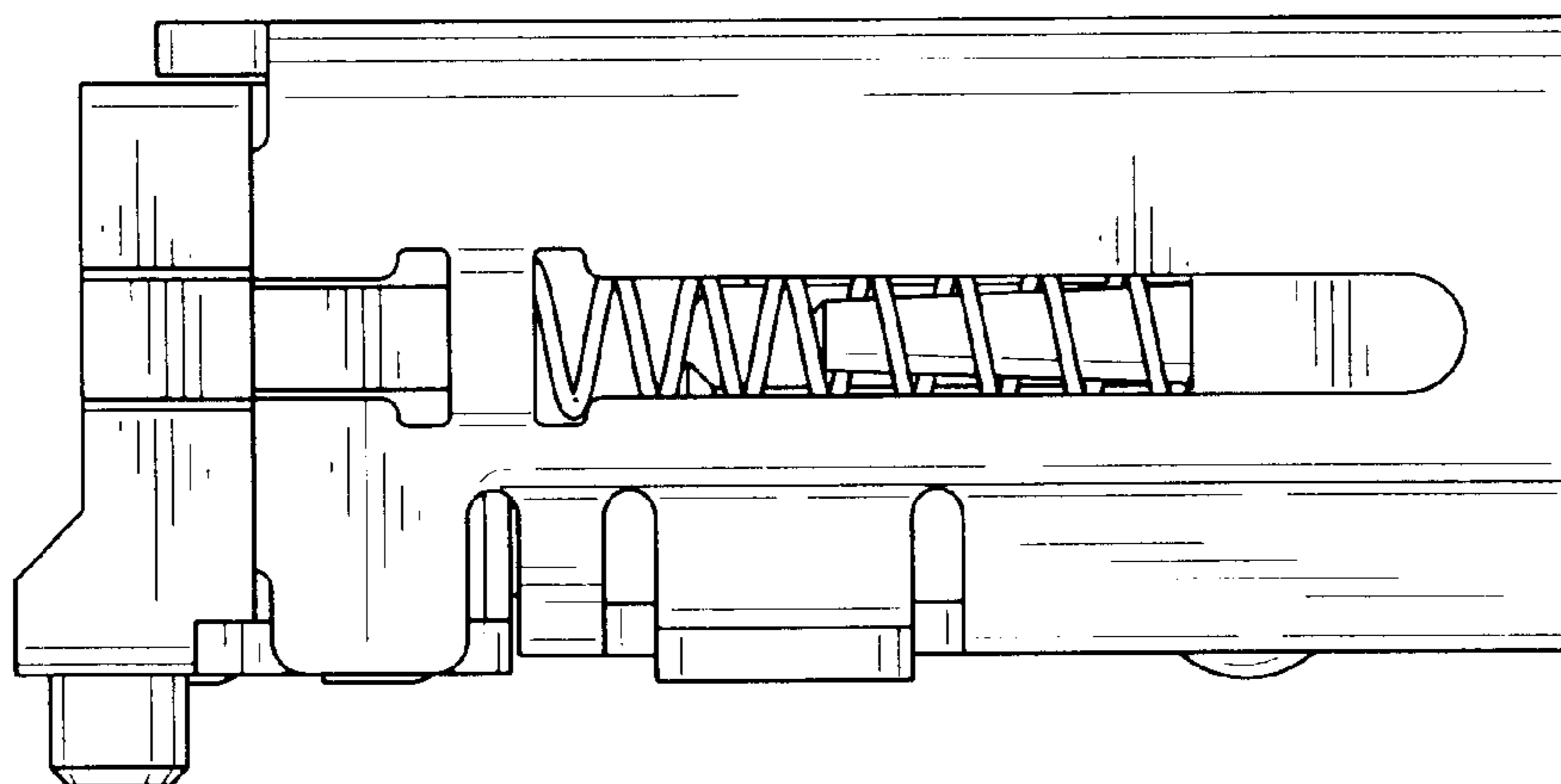

FIG. 6

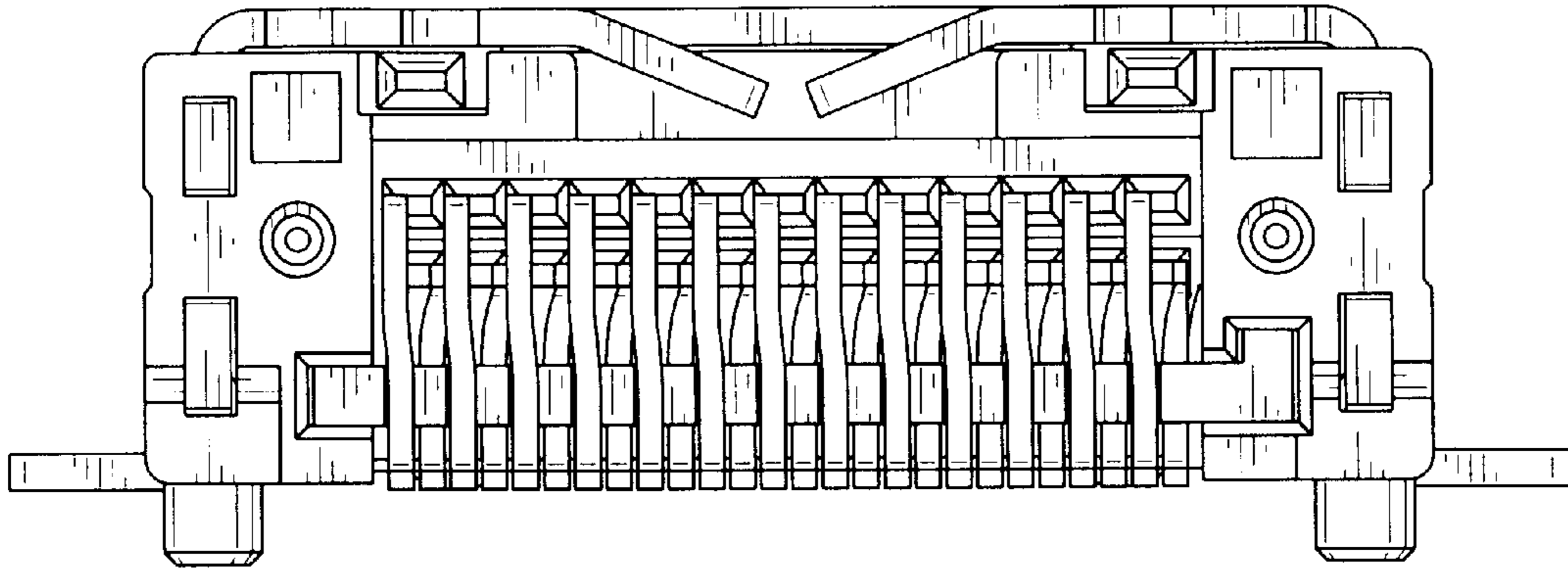

FIG. 7

