



US00D524641S

(12) **United States Design Patent**
Hamilton et al.

(10) **Patent No.:** **US D524,641 S**

(45) **Date of Patent:** **** Jul. 11, 2006**

(54) **SHOE BOX**

(75) Inventors: **Aulsondro L. Hamilton**, Valencia, CA (US); **William I. Chapman, II**, West Covina, CA (US); **Martin D. Woods**, Corona, CA (US)

(73) Assignee: **Headstart Entertainment**, Hollywood, CA (US)

(**) Term: **14 Years**

(21) Appl. No.: **29/224,222**

(22) Filed: **Feb. 25, 2005**

(51) **LOC (8) Cl.** **09-03**

(52) **U.S. Cl.** **D9/414**; D14/168

(58) **Field of Classification Search** D9/414, D9/418, 420, 432; D14/162, 163, 168; 206/278, 206/278.1, 296, 489.1; D3/200, 273, 309, D3/317

See application file for complete search history.

(56) **References Cited**

U.S. PATENT DOCUMENTS

- D75,891 S * 7/1928 Wolock D9/432
- D84,960 S * 8/1931 Schubart D9/614
- 2,333,643 A * 11/1943 Donnellan 383/38
- 3,063,550 A * 11/1962 Boden et al. 206/296
- 3,414,093 A * 12/1968 Chostner 190/16
- 4,244,508 A * 1/1981 Schulman 229/182

- D263,221 S * 3/1982 Hisano et al. D14/163
- D310,666 S * 9/1990 Yamamoto D14/163
- D318,863 S * 8/1991 Mori D14/163
- D344,890 S * 3/1994 Townes D9/418

* cited by examiner

Primary Examiner—Stella Reid

Assistant Examiner—Derrick Holland

(74) *Attorney, Agent, or Firm*—Birch, Stewart, Kolasch & Birch, LLP

(57) **CLAIM**

The ornamental design for a shoe box, as shown and described.

DESCRIPTION

FIG. 1 is a front perspective view of a shoe box in accordance with my new design;
 FIG. 2 is a rear perspective view thereof;
 FIG. 3 is a front elevational view thereof;
 FIG. 4 is an elevational view thereof from the right side, the opposite side being identical;
 FIG. 5 is a top plan view thereof;
 FIG. 6 is a bottom plan view thereof;
 FIG. 7 is a rear elevational view thereof; and,
 FIG. 8 is a front elevational view thereof, with covers moved to partially open positions.
 The broken lines showing is for illustrative purposes only and forms no part of the claimed design.

1 Claim, 6 Drawing Sheets

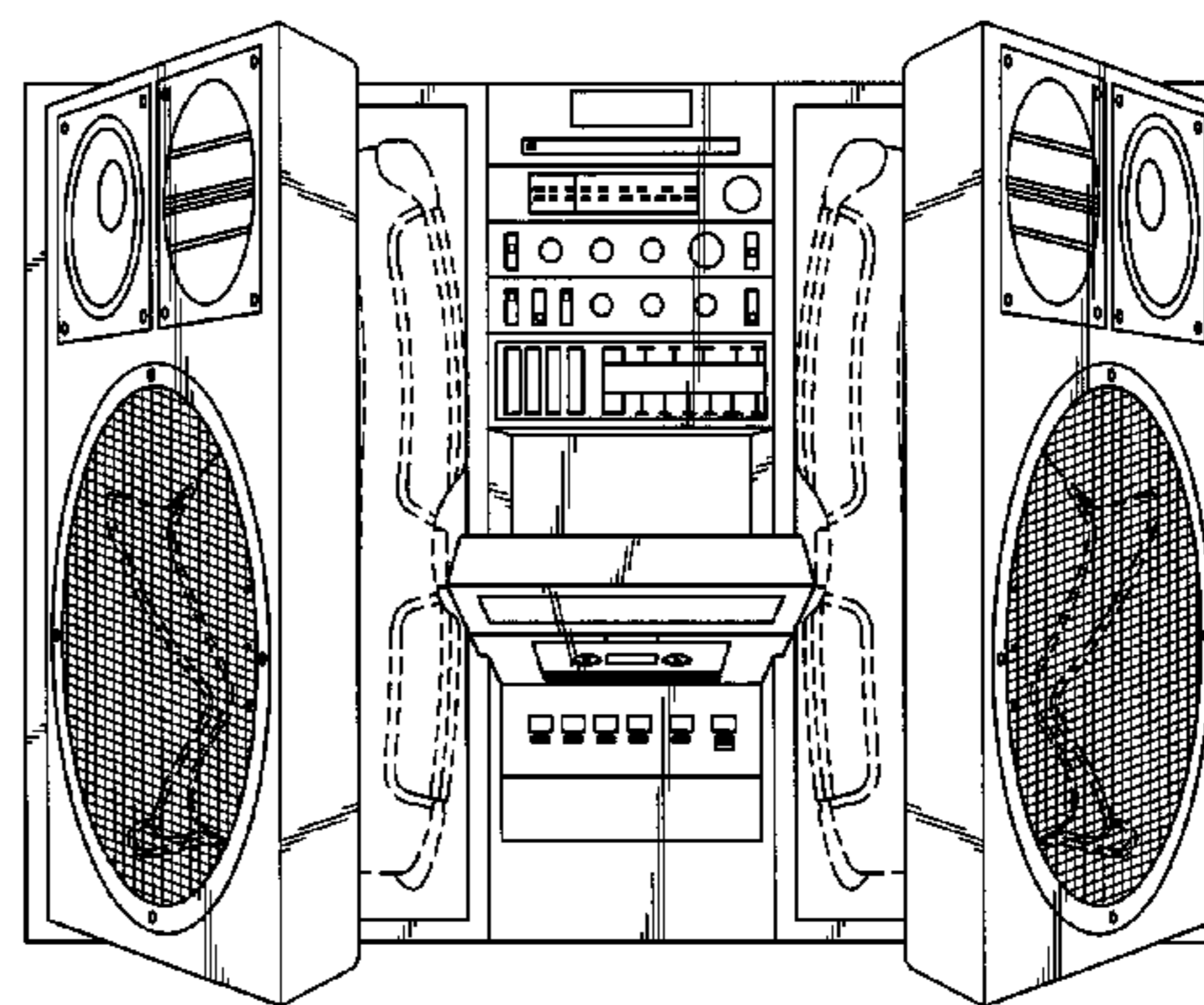
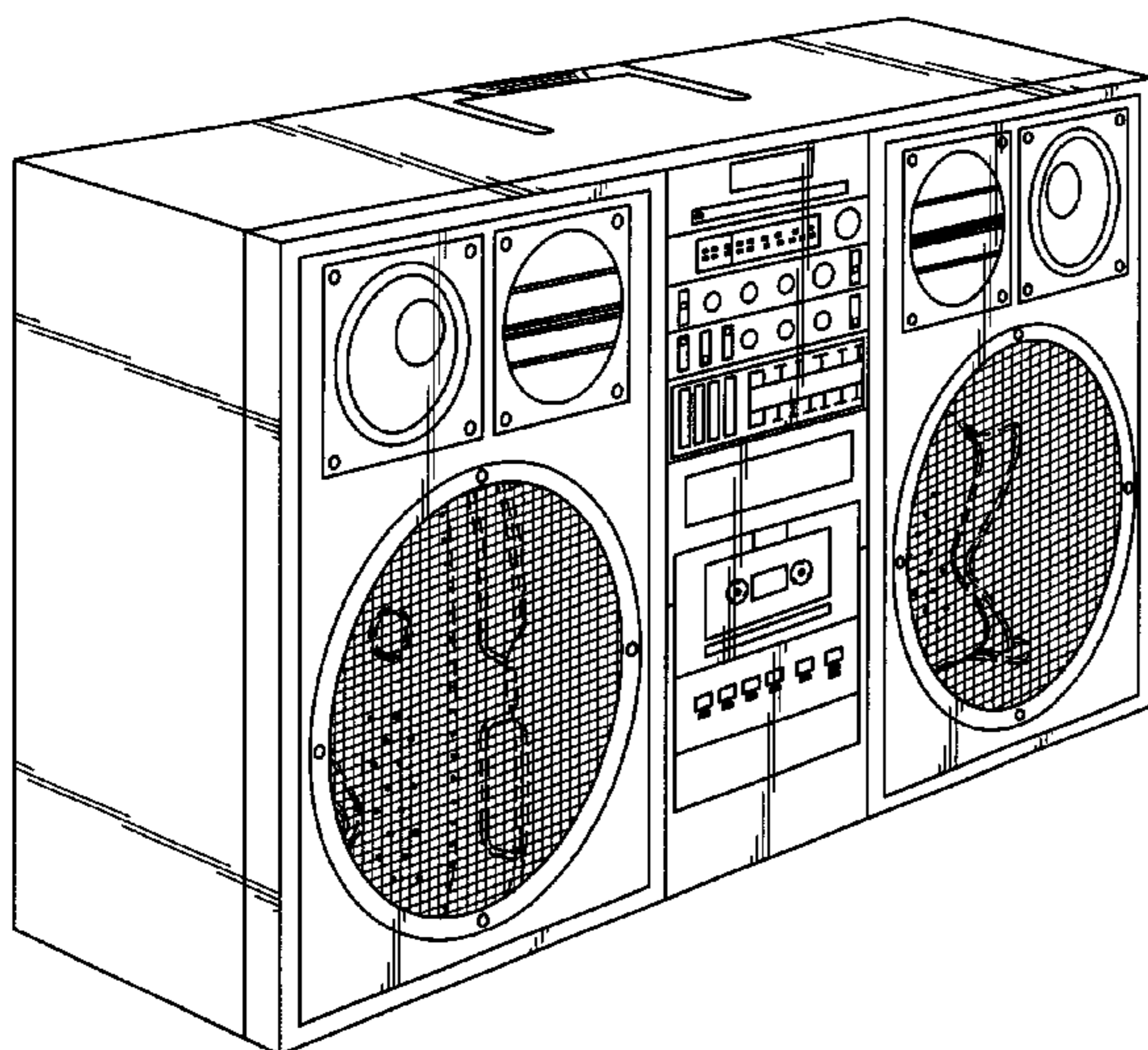

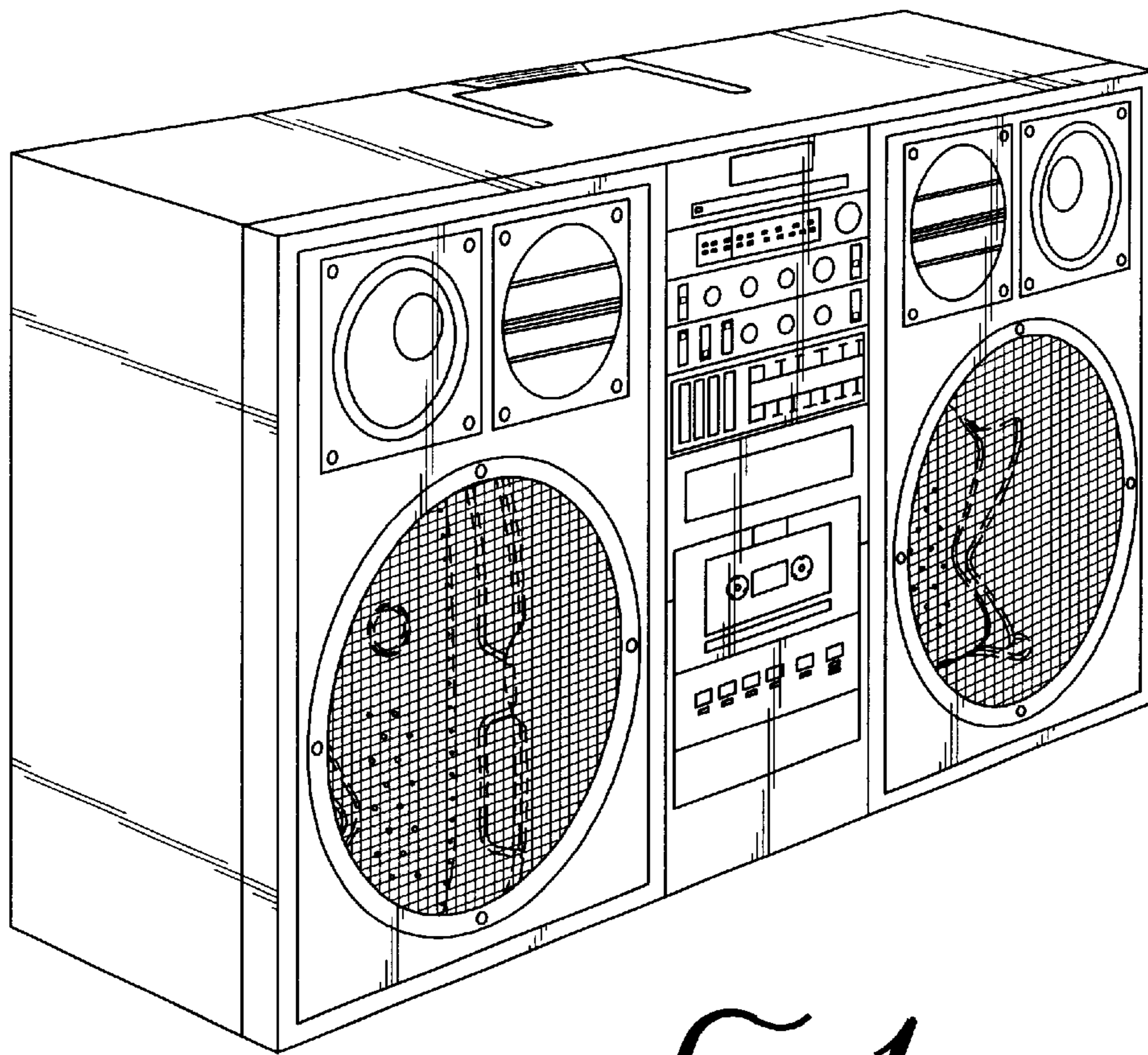

FIG. 1

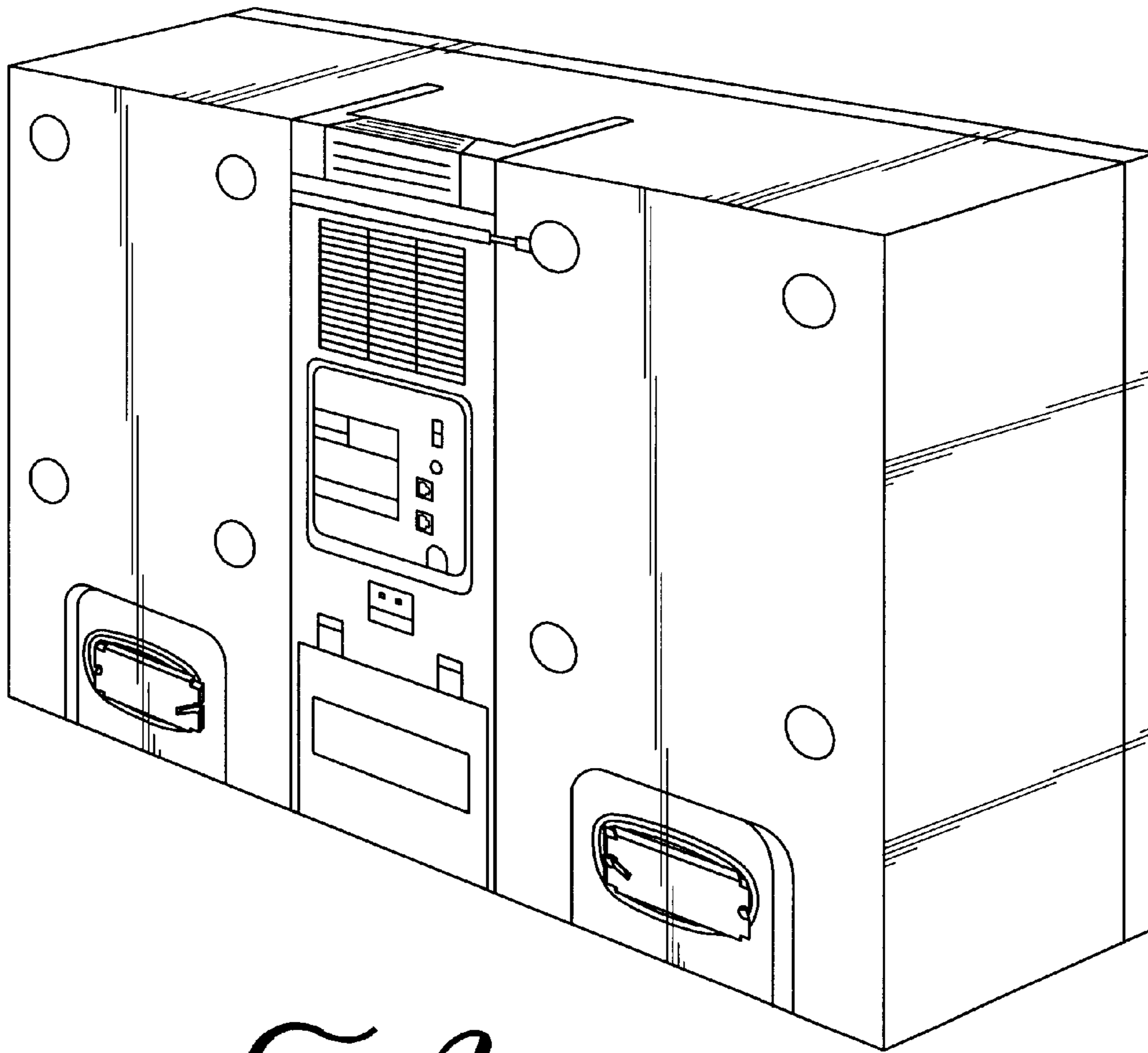

FIG. 2

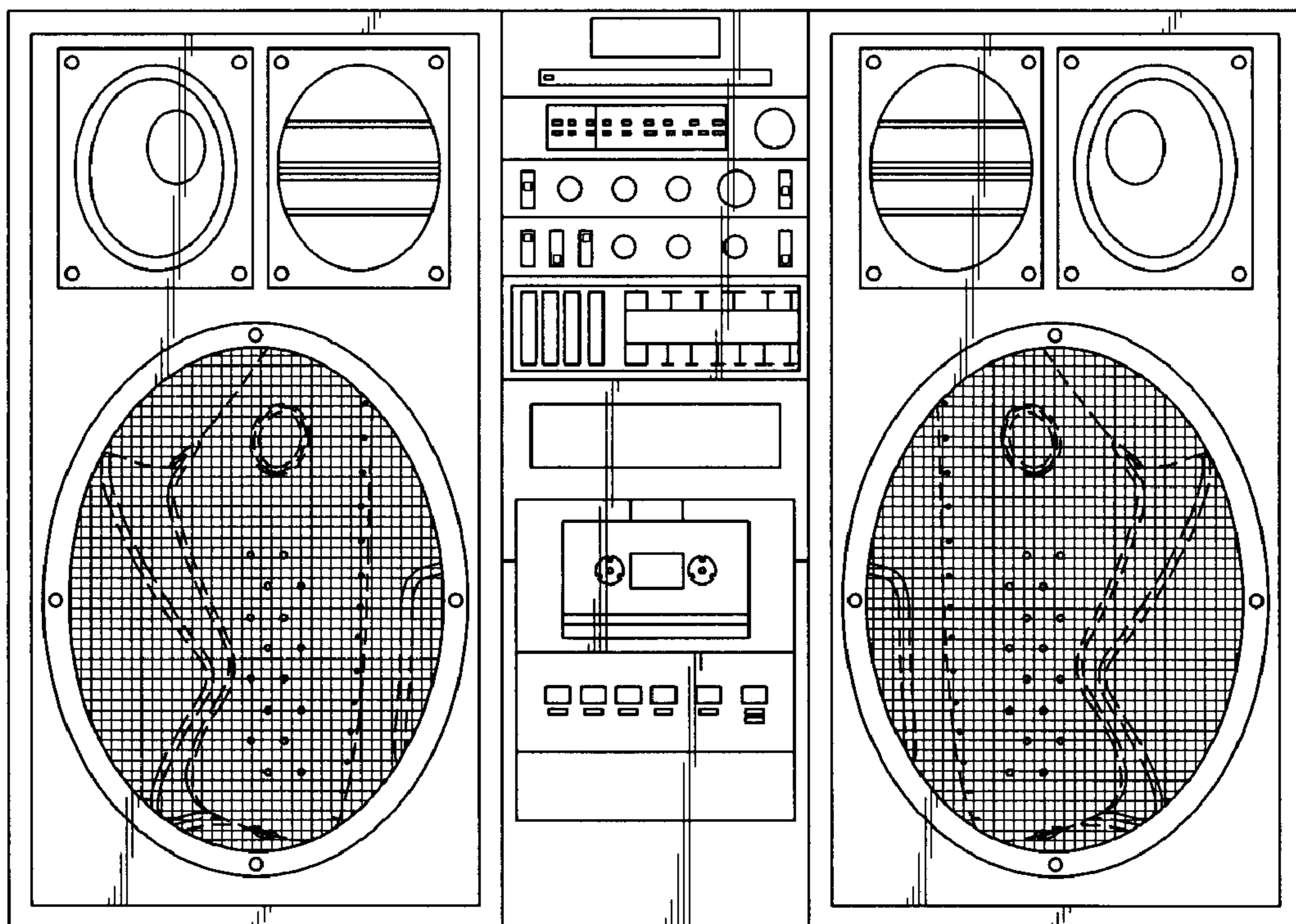

FIG. 3

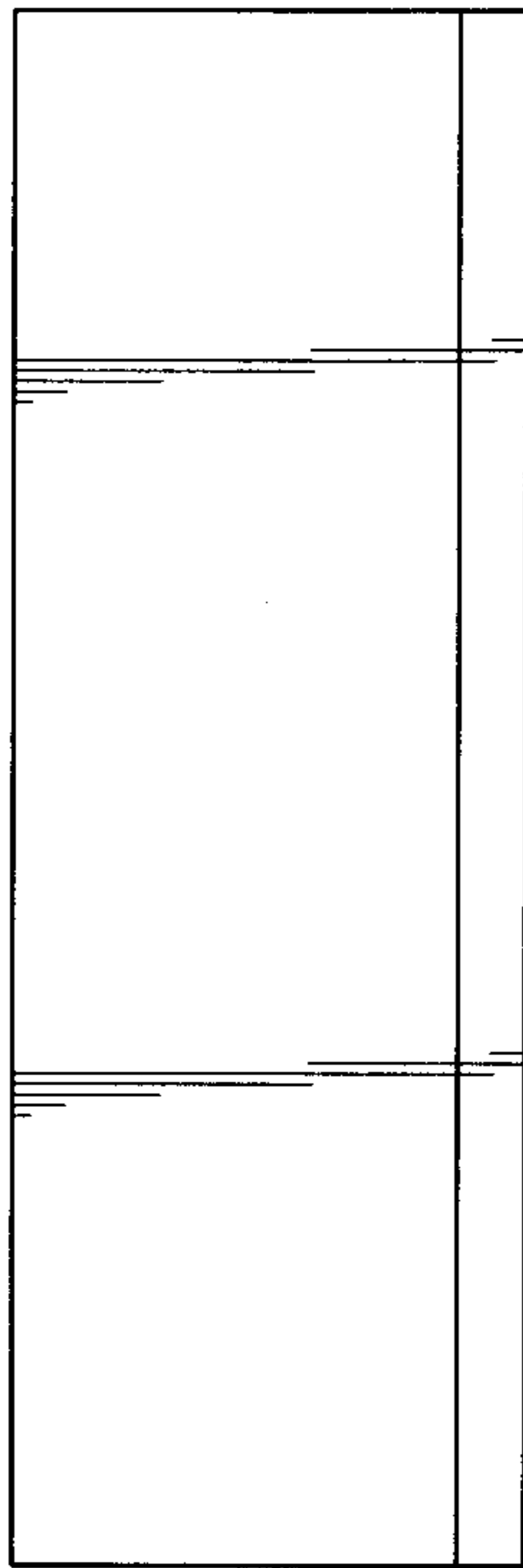

FIG. 4

FIG. 5

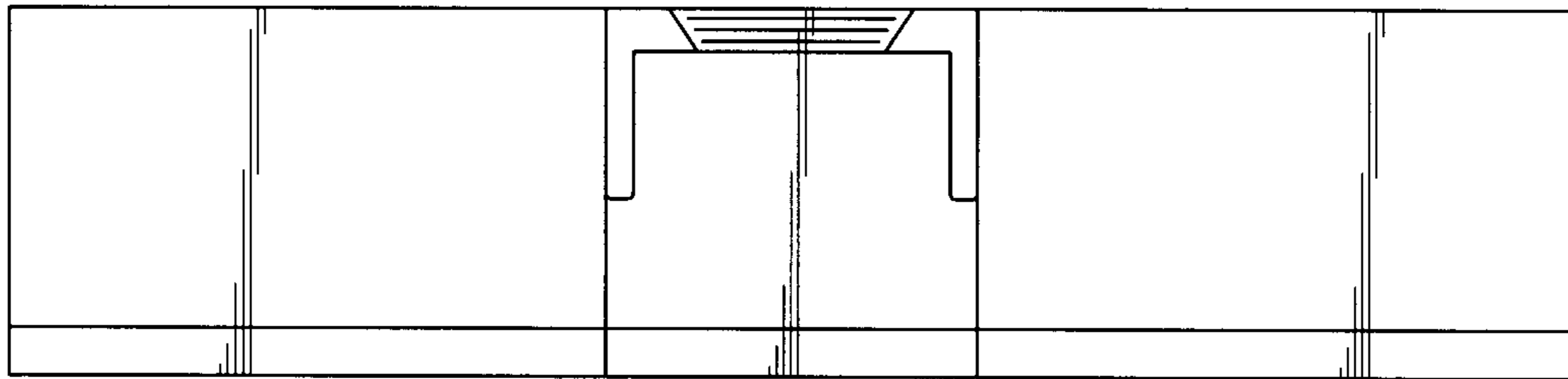
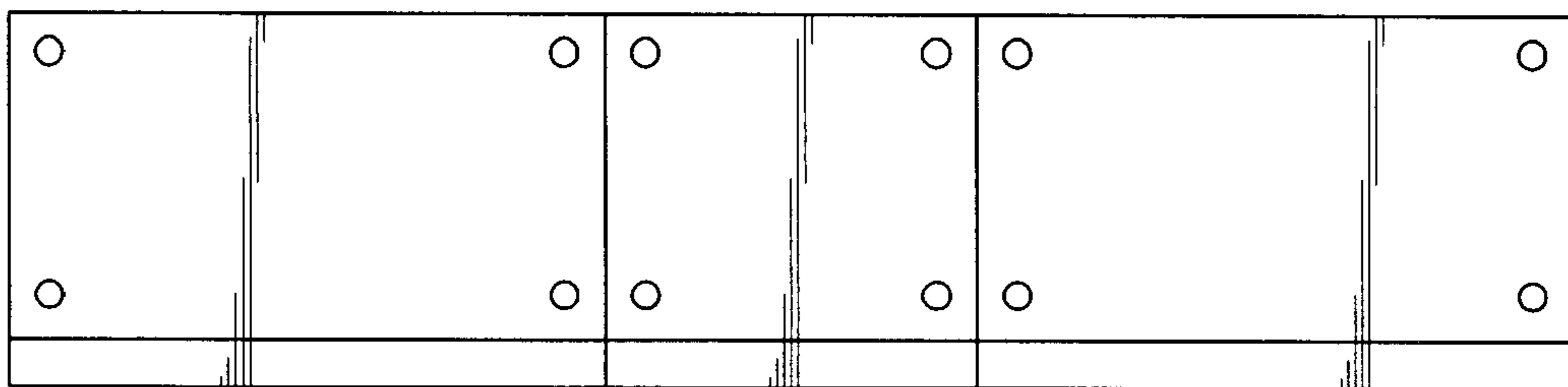

FIG. 6



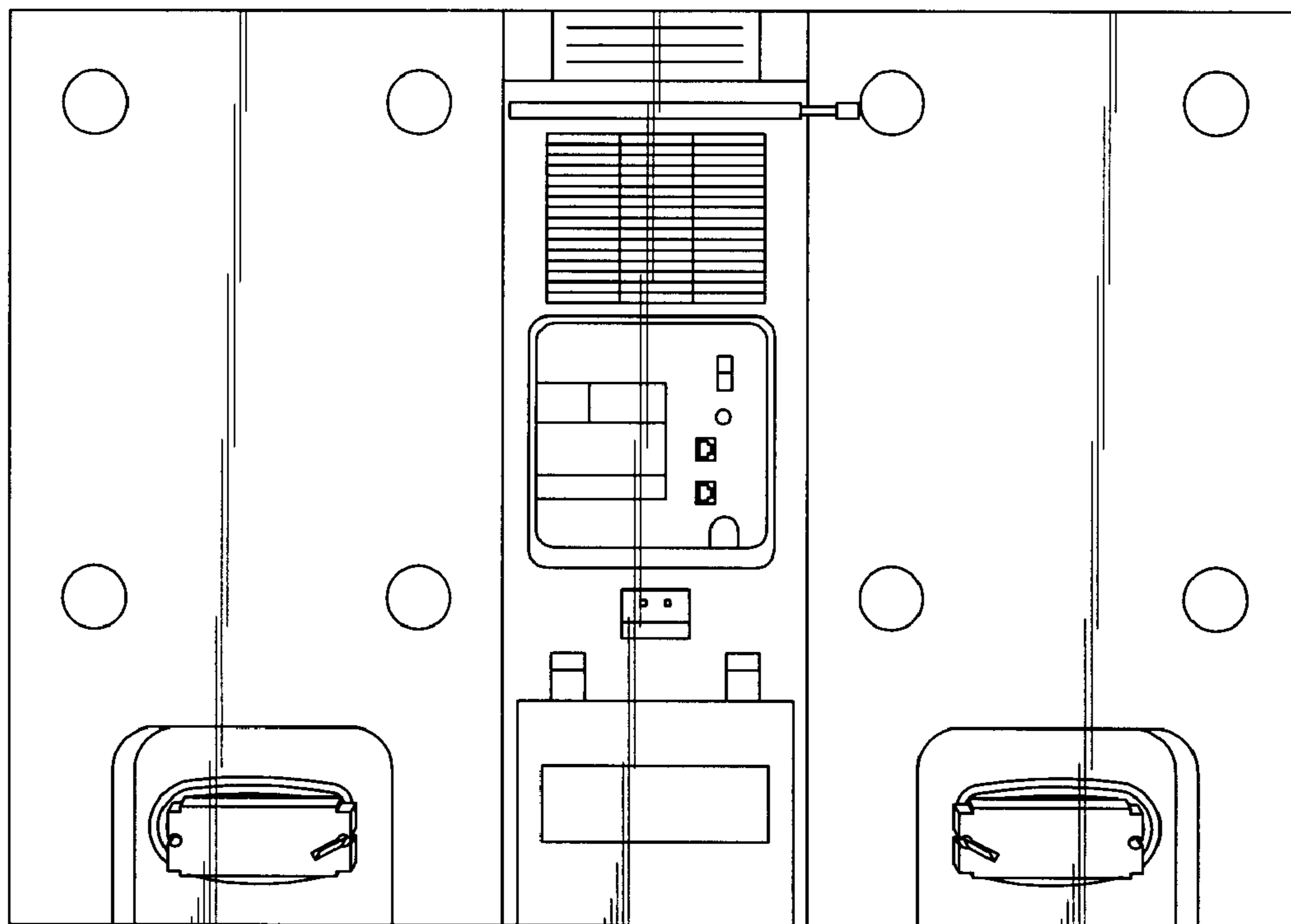

FIG. 7

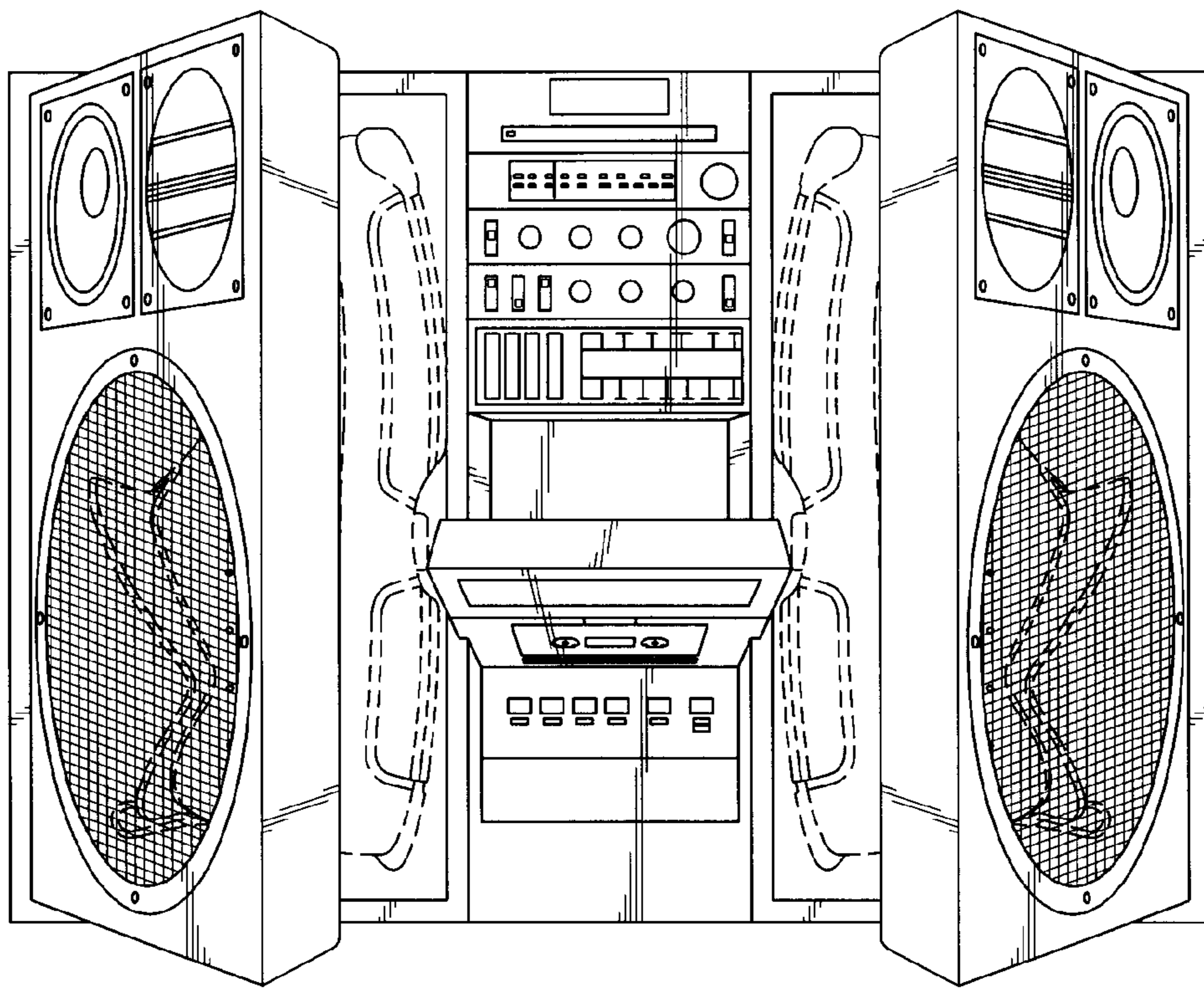

FIG. 8