



US00D524521S

(12) **United States Design Patent** (10) **Patent No.:** **US D524,521 S**  
**Racine** (45) **Date of Patent:** **\*\* Jul. 11, 2006**

(54) **PORTION OF A SHOE MIDSOLE**  
 (75) Inventor: **Bertrand Racine**, Portland, OR (US)  
 (73) Assignee: **Nike, Inc.**, Beaverton, OR (US)  
 (\*\*) Term: **14 Years**  
 (21) Appl. No.: **29/236,519**  
 (22) Filed: **Aug. 18, 2005**  
 (51) **LOC (8) Cl.** ..... **02-99**  
 (52) **U.S. Cl.** ..... **D2/964**  
 (58) **Field of Classification Search** ..... D2/902,  
 D2/906-908, 943, 944, 946, 972-974, 977;  
 36/45, 50.1, 77 M, 77 R, 83, 88, 113, 114,  
 36/126-131, 27-29, 32 R  
 See application file for complete search history.

(56) **References Cited**  
 U.S. PATENT DOCUMENTS

D48,040 S	10/1915	Phillips
D54,601 S	3/1920	Cochrane
D60,607 S	3/1922	Delbon
D325,288 S	4/1992	Richard et al.
5,247,742 A	9/1993	Kilgore et al.
D344,174 S	2/1994	Kilgore
D344,398 S	2/1994	Kilgore
D344,399 S	2/1994	Kilgore

(Continued)

OTHER PUBLICATIONS

Nike Footwear Catalog Fall 1997, p. 44, published Dec. 1996.  
 Nike Footwear Catalog Late Spring 2001, p. M5, published Sep. 2000.  
 Nike Footwear Catalog Holiday 2001, p. M34, published Feb. 2001.  
 Nike Footwear Catalog Spring 2002, p. M29, published Jun. 2001.  
 Nike Footwear Catalog Spring 2003, p. M6, published Jun. 2002.

Nike Footwear Catalog Holiday 2003, p. M82, published Mar. 2003.  
 Nike Footwear Catalog Spring 2004, pp. M31 and M40, published Jun. 2003.  
 Nike Footwear Catalog Holiday 2004, pp. M5, M7, M11, & M12, published Mar. 2004.  
 Nike Footwear Catalog Holiday 2004, pp. M31, M40, M41, & M77, published Mar. 2004.  
 Nike Footwear Catalog Holiday 2004, pp. W6, W19, W28, W43, & W55, published Mar. 2004.  
 Nike Footwear Catalog Fall 2004, pp. M35, M34 & M41, published Nov. 2003.  
 Nike Footwear Catalog Late Spring 2004, pp. M3, M6 & M33, published Sep. 2003.

*Primary Examiner*—Dominic Simone  
 (74) *Attorney, Agent, or Firm*—Banner & Witcoff, Ltd.

(57) **CLAIM**

The ornamental design for a portion of a shoe midsole, as shown and described.

**DESCRIPTION**

FIG. 1 is a front perspective view of a first embodiment of a portion of a shoe midsole showing my new design; FIG. 2 is a rear perspective view thereof; FIG. 3 is a side elevational view of one side thereof; FIG. 4 is a side elevational view of the other side thereof; FIG. 5 is an enlarged cross sectional view taken along the line 5—5 of FIG. 3; FIG. 6 is a front perspective view of a second embodiment of a portion of a shoe midsole showing my new design; FIG. 7 is a rear perspective view thereof; FIG. 8 is a side elevational view of one side thereof; FIG. 9 is side elevational view of the other side thereof; and, FIG. 10 is an enlarged cross sectional view taken along the line 10—10 of FIG. 8.

The unshaded areas in the claimed regions shown FIGS. 1-3 and 5 are for illustrative purposes only and form no part of the claimed design. The broken line showing of the shoe upper and the remainder of the shoe sole is for illustrative purposes only and forms no part of the claimed design.

**1 Claim, 10 Drawing Sheets**

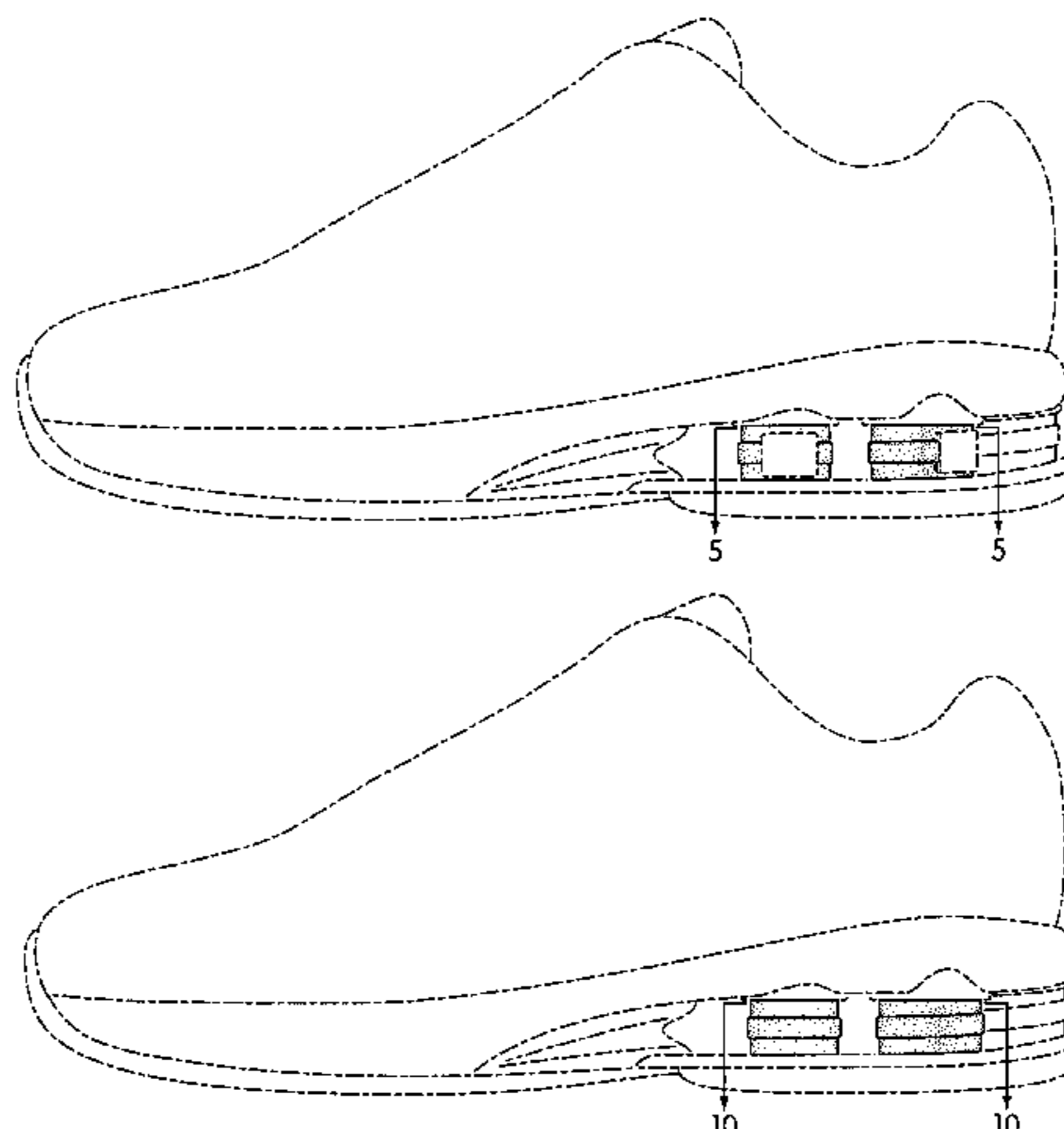

# US D524,521 S

Page 2

## U.S. PATENT DOCUMENTS

D344,400 S	2/1994	Kilgore	D446,387 S	8/2001	McCourt	
D344,401 S	2/1994	Kilgore	D446,923 S	8/2001	McCourt	
D350,018 S	8/1994	Kilgore	D447,330 S	9/2001	McCourt	
D350,019 S	8/1994	Kilgore	D450,437 S	11/2001	Simpson et al.	
D350,020 S	8/1994	Kilgore	D462,830 S	9/2002	Greene	
D350,225 S	9/1994	Kilgore	6,457,261 B1	10/2002	Crary	
D350,227 S	9/1994	Kilgore	D474,581 S	5/2003	Cooper	
D350,433 S	9/1994	Kilgore	D474,582 S	5/2003	Cooper	
5,343,639 A	9/1994	Kilgore et al.	6,568,102 B1 *	5/2003	Healy et al. ....	36/28
D351,057 S	10/1994	Kilgore	D476,474 S	7/2003	McDowell	
D351,720 S	10/1994	Kilgore	D483,936 S	12/2003	Fullum	
5,353,523 A	10/1994	Kilgore et al.	D483,937 S	12/2003	Fullum	
D351,936 S	11/1994	Kilgore	D485,053 S	1/2004	McDowell	
D352,159 S	11/1994	Kilgore	D485,975 S	2/2004	McDowell	
D352,160 S	11/1994	Kilgore	D498,914 S	11/2004	Sokolowski	
D354,617 S	1/1995	Kilgore	D499,248 S	12/2004	Sokolowski	
D429,877 S	8/2000	Lozano et al.	D500,402 S	1/2005	Sokolowski	
D431,898 S	10/2000	Clegg et al.	D509,051 S *	9/2005	O'Connor .....	D2/964
D432,293 S	10/2000	Clegg et al.	D510,472 S *	10/2005	Sokolowski .....	D2/964
D432,764 S	10/2000	Clegg et al.	6,964,120 B1 *	11/2005	Cartier et al. ....	36/29
D433,216 S	11/2000	Avar et al.	6,968,636 B1 *	11/2005	Aveni et al. ....	36/28

\* cited by examiner

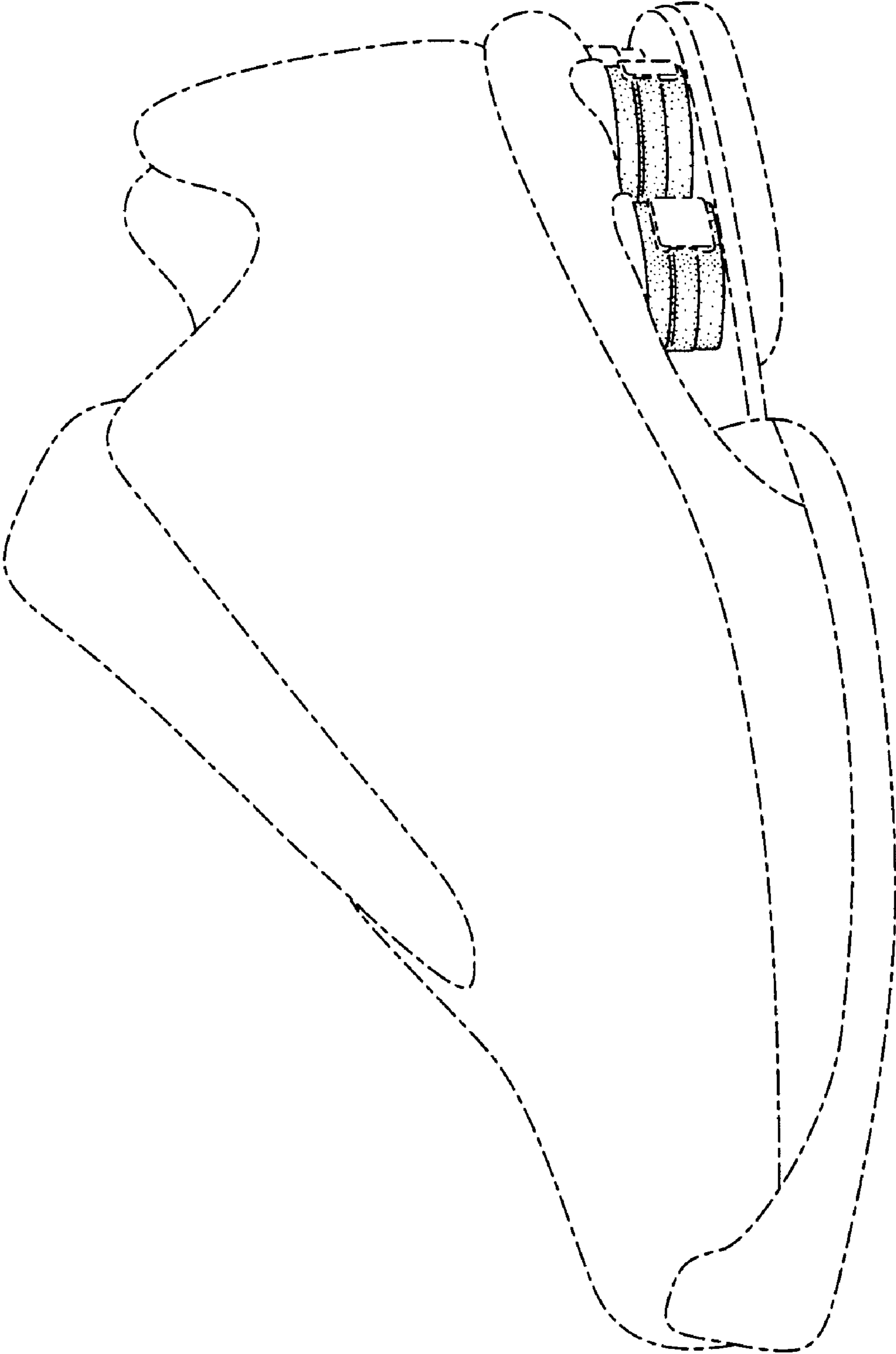

FIG. 1

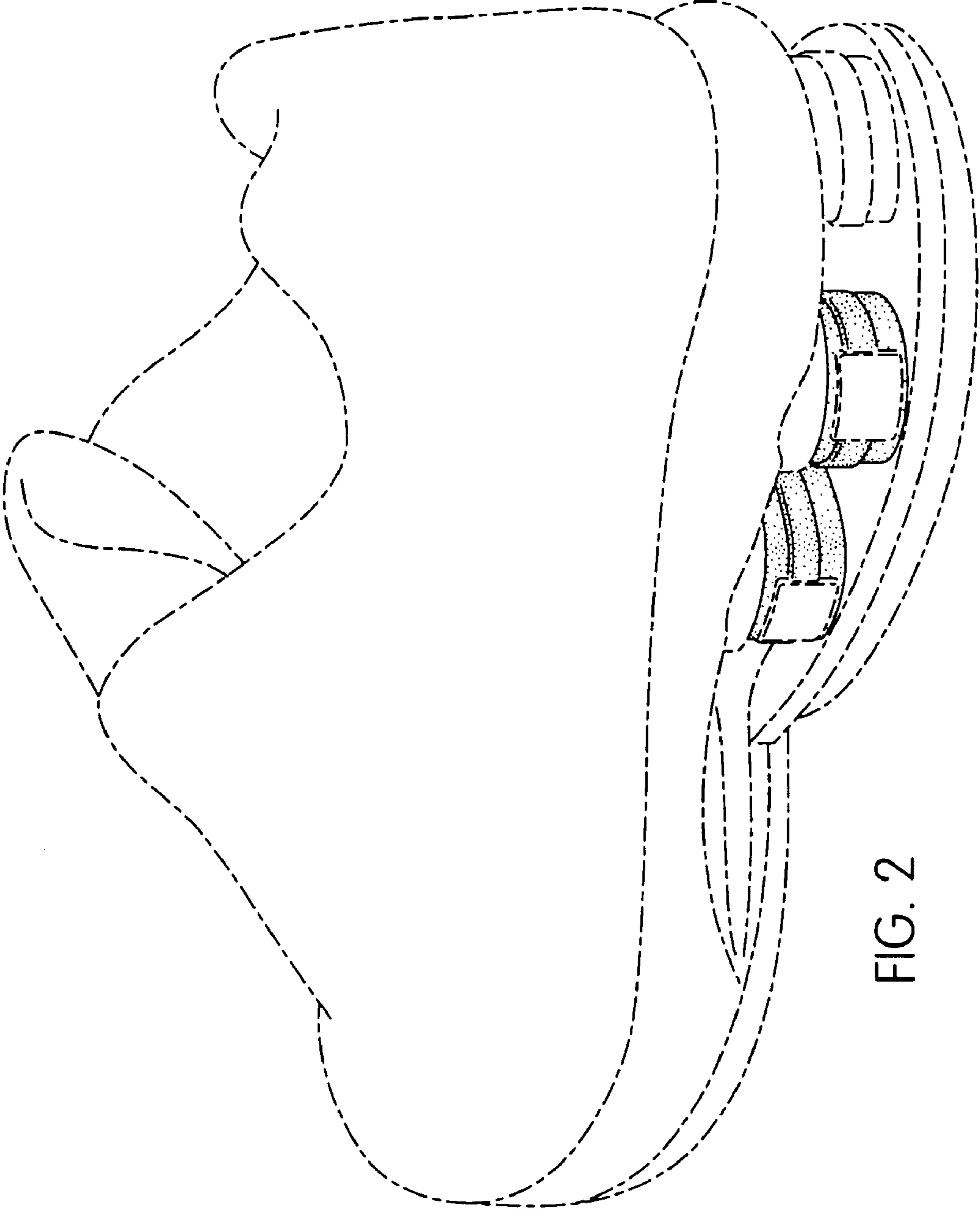

FIG. 2

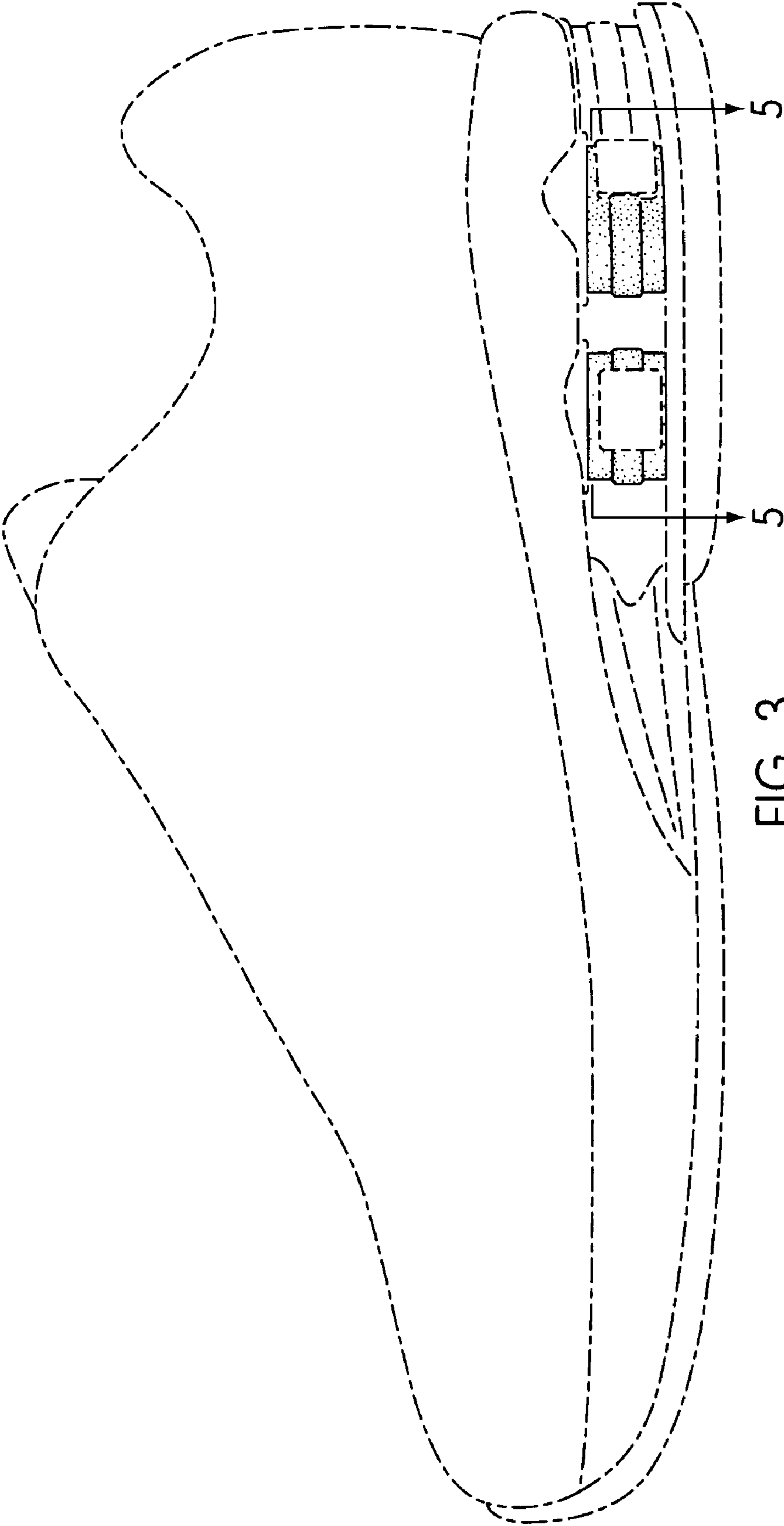

FIG. 3



FIG. 4

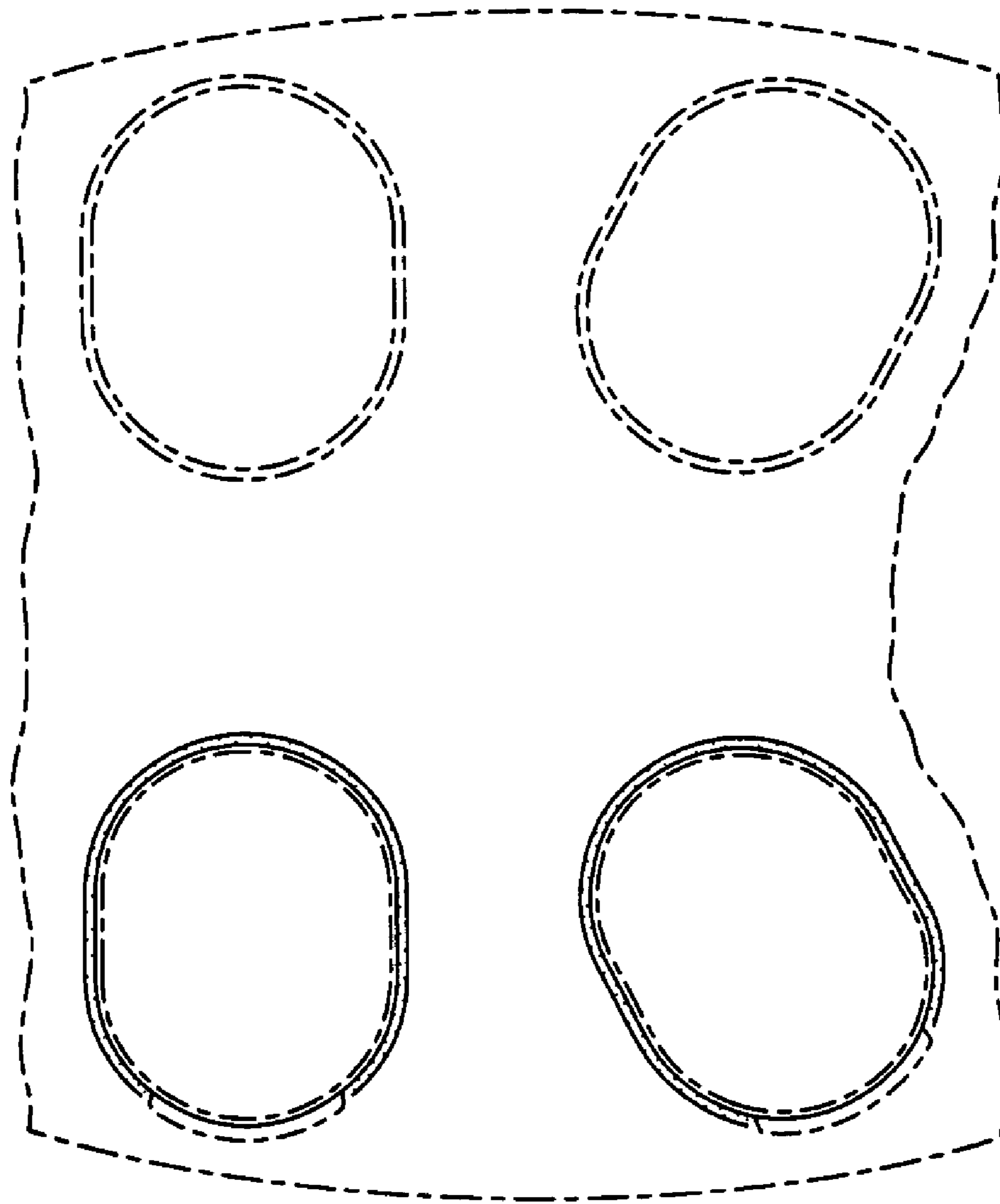

FIG. 5

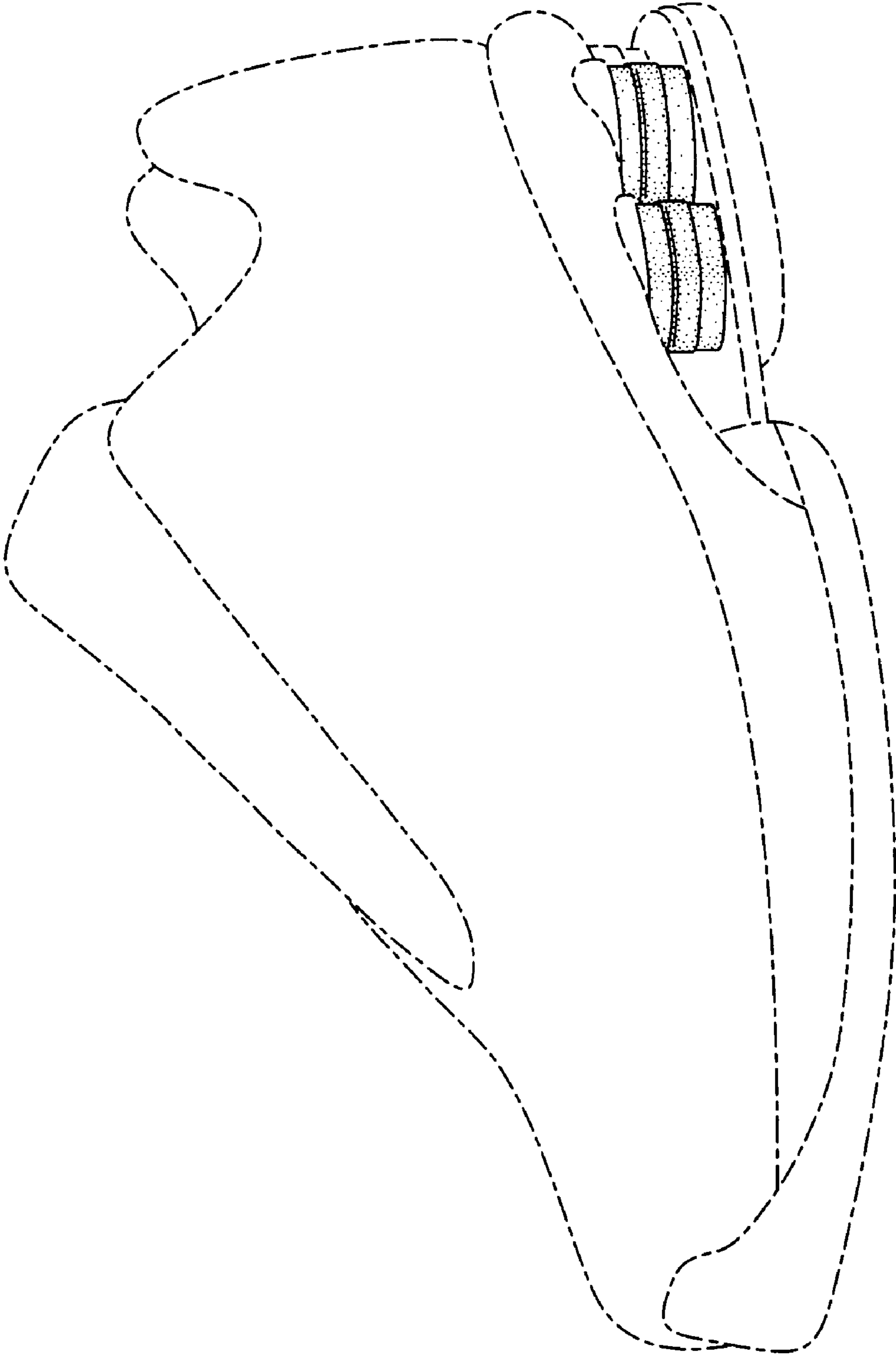

FIG. 6



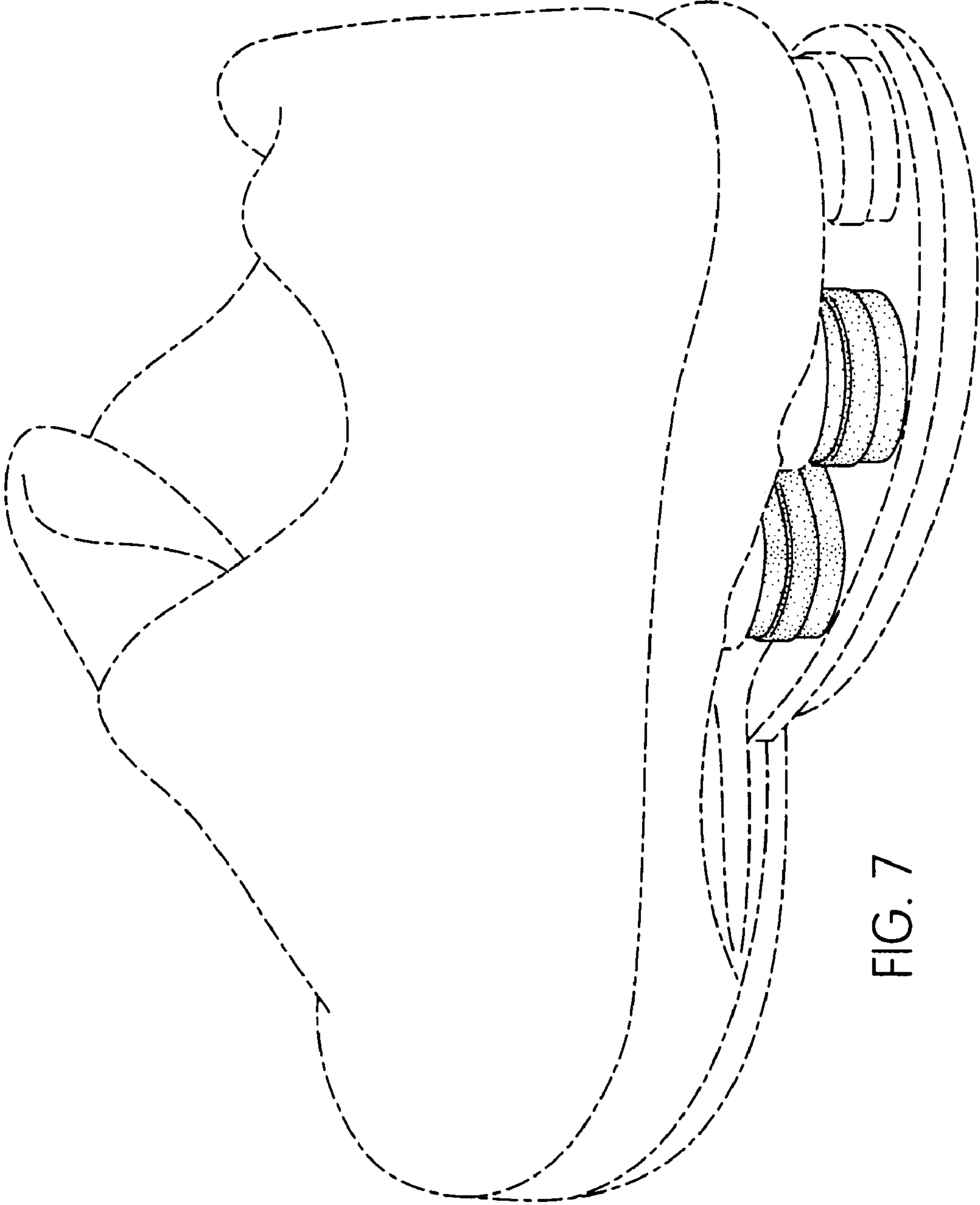

FIG. 7

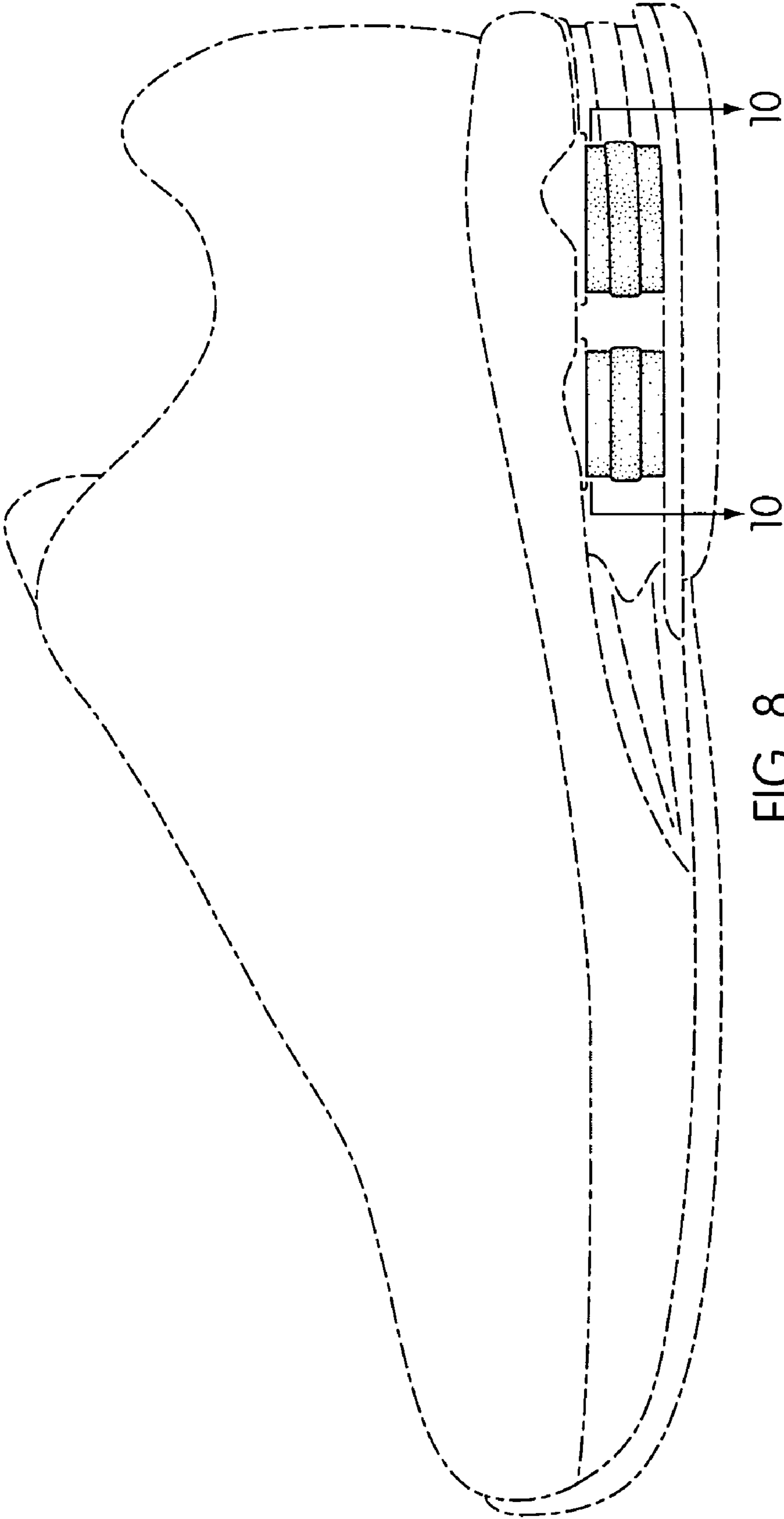

FIG. 8



FIG. 9

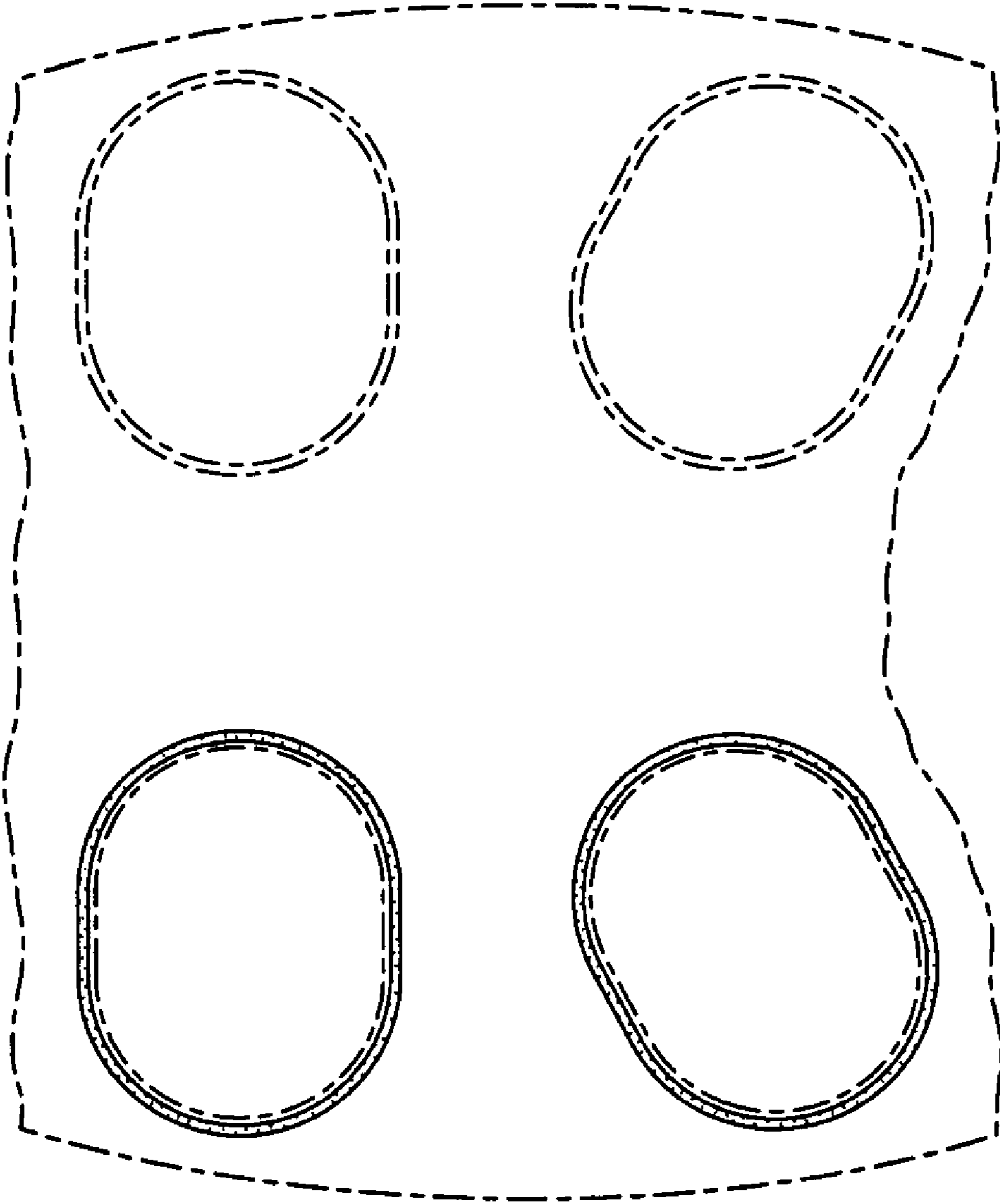

FIG. 10