



US00D524502S

(12) **United States Design Patent**
Picozza et al.

(10) **Patent No.:** **US D524,502 S**

(45) **Date of Patent:** **** Jul. 4, 2006**

(54) **IRON**

(75) Inventors: **Augusto Picozza**, Boca Raton, FL (US); **John O. Bowser**, Boynton Beach, FL (US); **Aaron Hughes**, San Francisco, CA (US); **Raul Chinda**, Fort Lauderdale, FL (US)

(73) Assignee: **Sunbeam Products, Inc.**, Boca Raton, FL (US)

(**) Term: **14 Years**

(21) Appl. No.: **29/222,770**

(22) Filed: **Feb. 2, 2005**

(51) **LOC (8) Cl.** **07-05**

(52) **U.S. Cl.** **D32/70**

(58) **Field of Classification Search** D32/68-72;
38/74-75, 77.1-77.9, 88, 90, 93; 219/245-248,
219/252

See application file for complete search history.

(56) **References Cited**

U.S. PATENT DOCUMENTS

2,201,601 A * 5/1940 Webster, Jr. 38/96

2,398,579 A * 4/1946 Clark et al. 38/90
D315,433 S * 3/1991 Chen D32/68
D402,779 S * 12/1998 Gudefin D32/70
D459,562 S * 6/2002 Page et al. D32/70
D468,070 S * 12/2002 Fujita et al. D32/70
D485,035 S * 1/2004 Schupp D32/70
D488,275 S * 4/2004 Gudefin D32/70

* cited by examiner

Primary Examiner—Pamela Burgess

(74) *Attorney, Agent, or Firm*—Lawrence J. Shurupoff

(57) **CLAIM**

The ornamental design for an iron, as shown and described.

DESCRIPTION

FIG. 1 is a top, right, front perspective view of an iron showing our new design;

FIG. 2 is a left side elevation view thereof;

FIG. 3 is a front view thereof;

FIG. 4 is a right side elevation view thereof;

FIG. 5 is a rear view thereof; and,

FIG. 6 is a top plan view thereof.

The broken lines shown in all Figures are for illustrative purposes only and form no part of the claimed design.

1 Claim, 6 Drawing Sheets

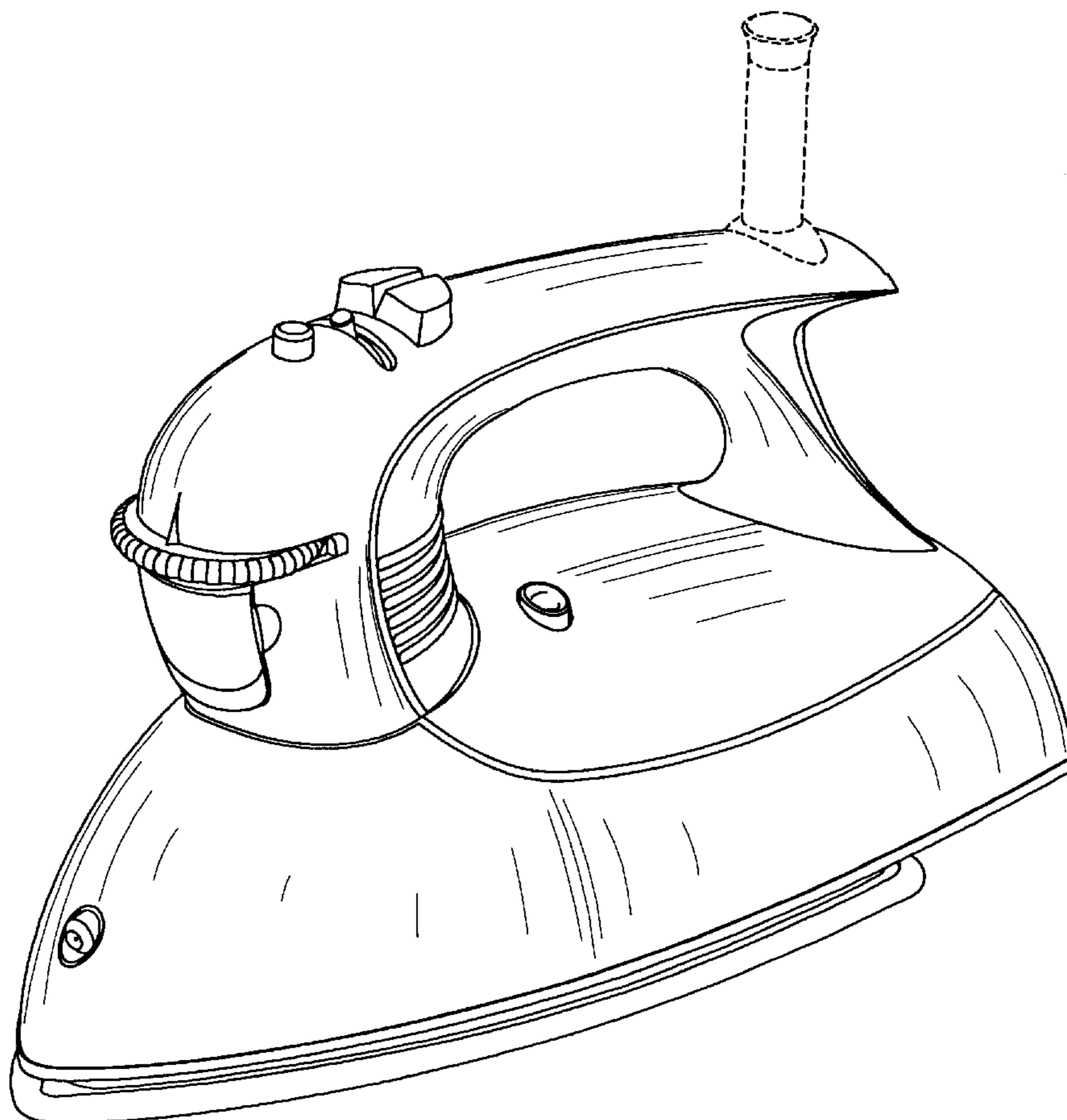

FIG 1

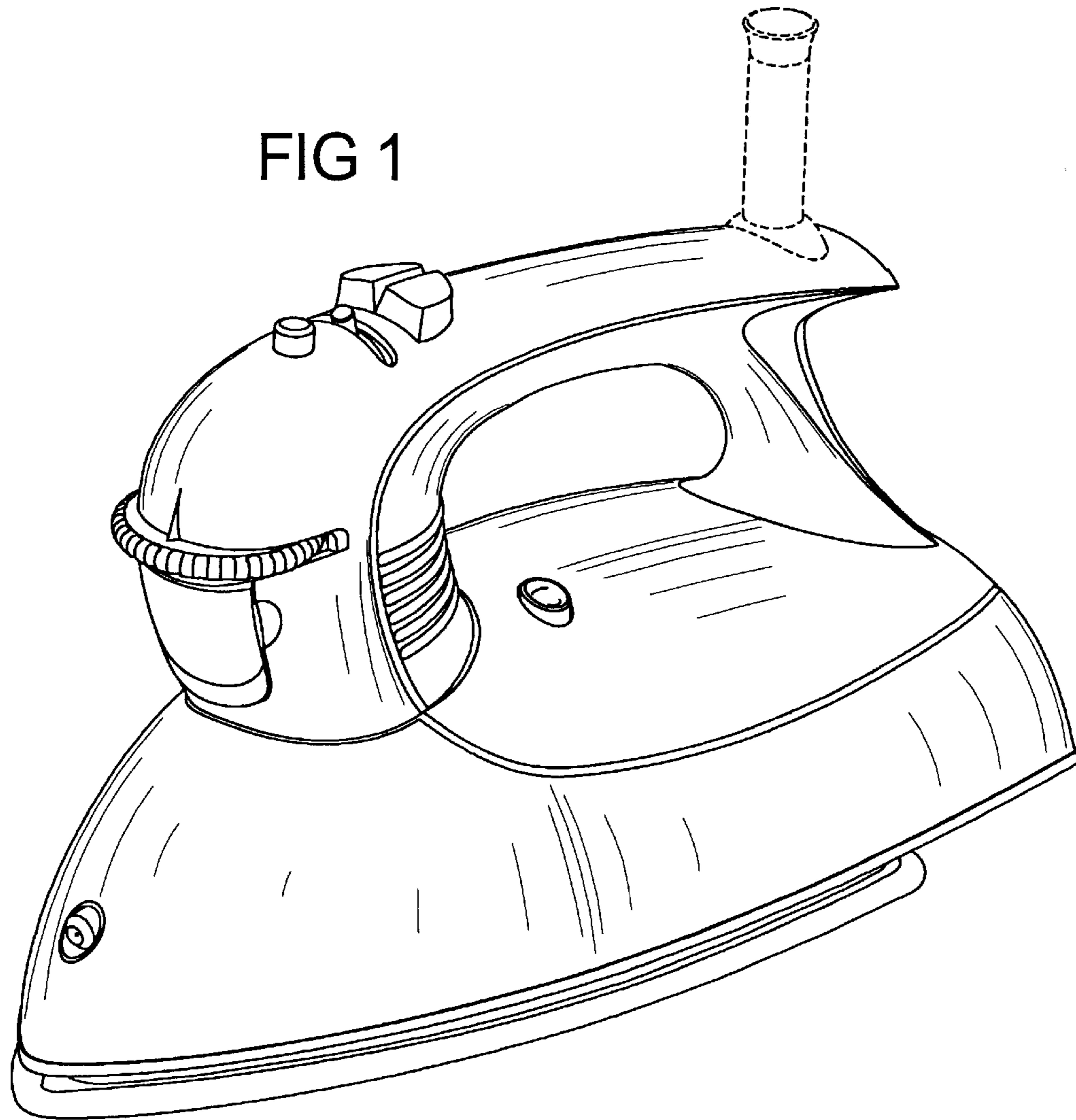

FIG 2

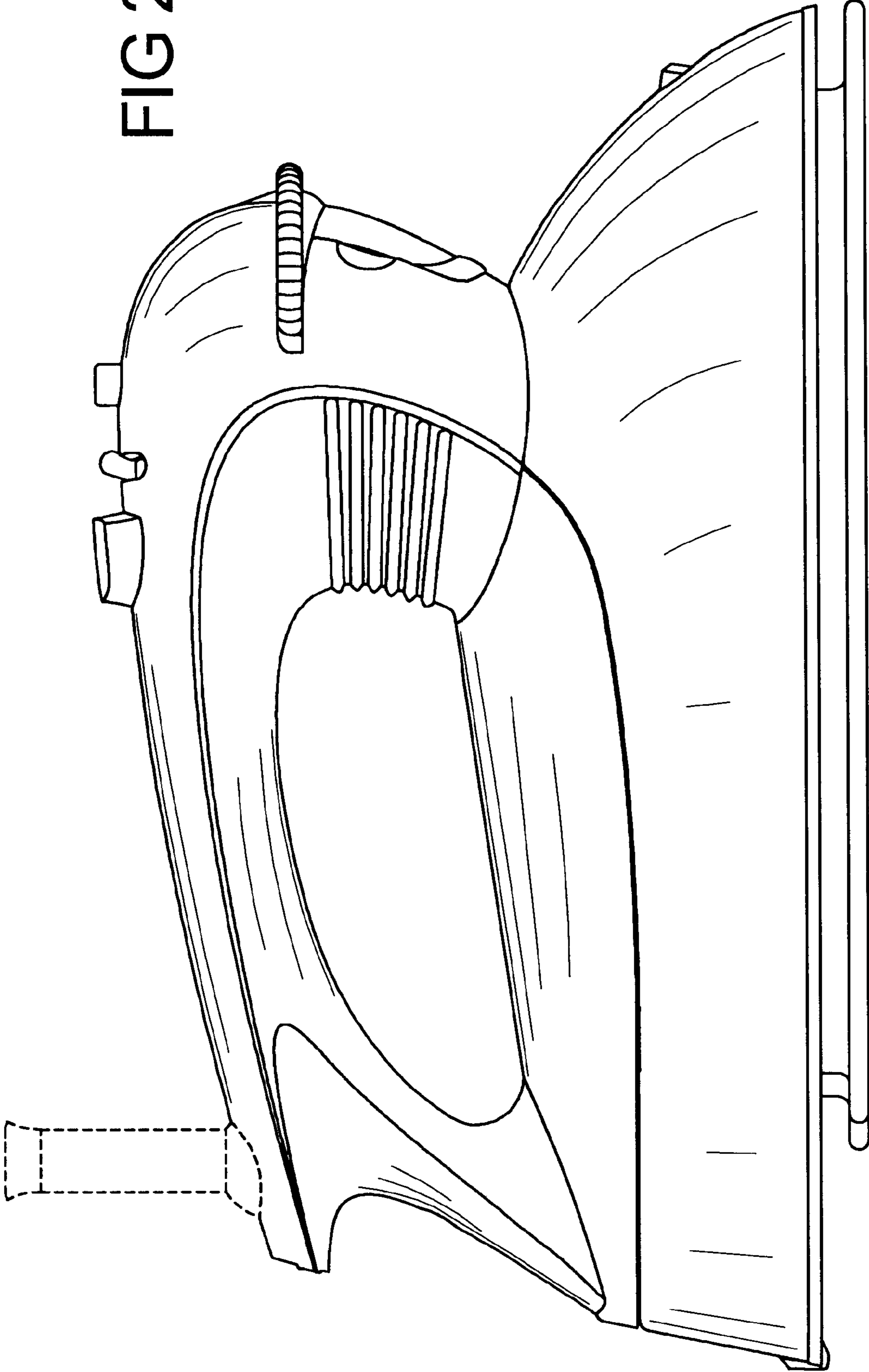
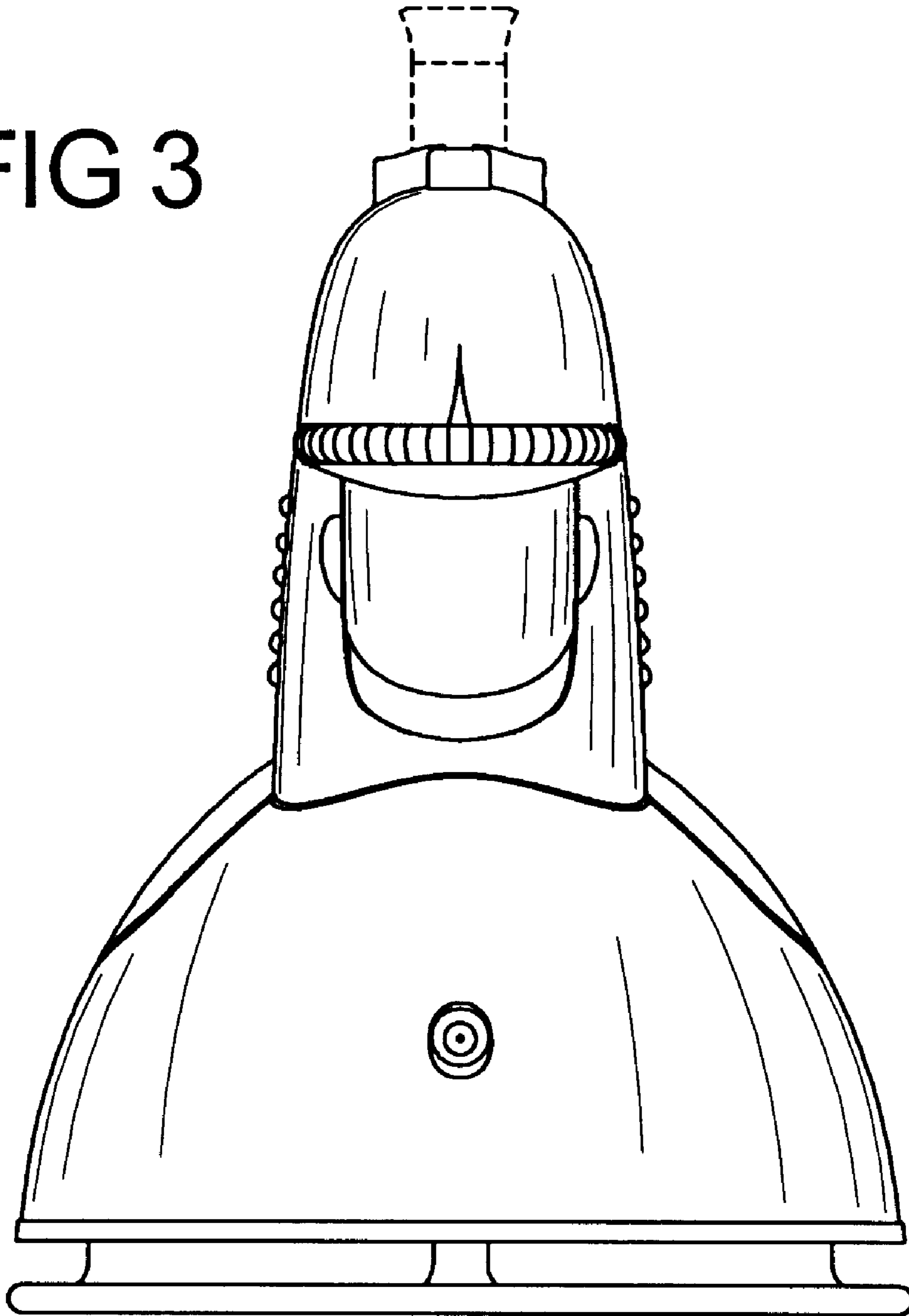

FIG 3



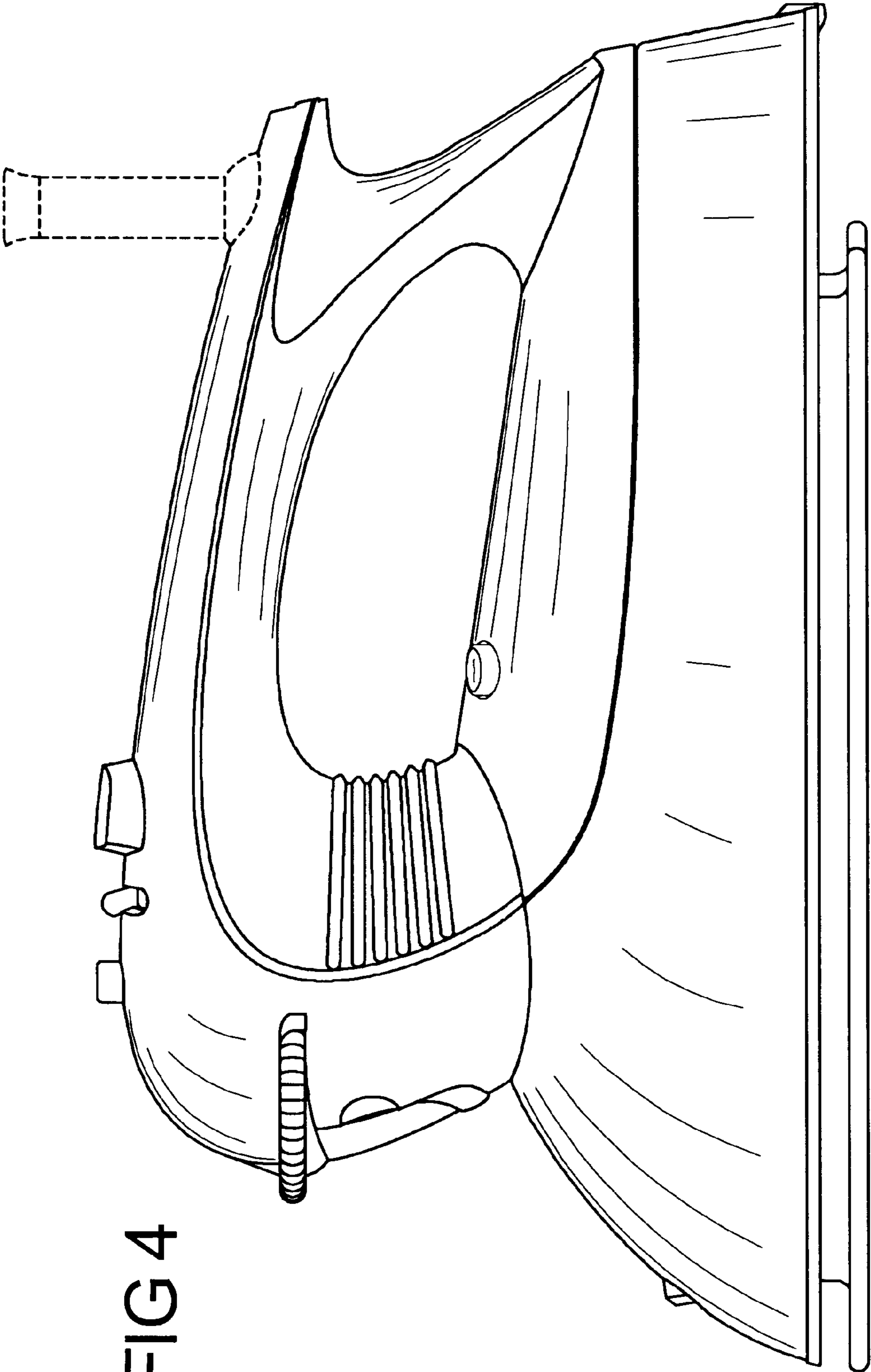
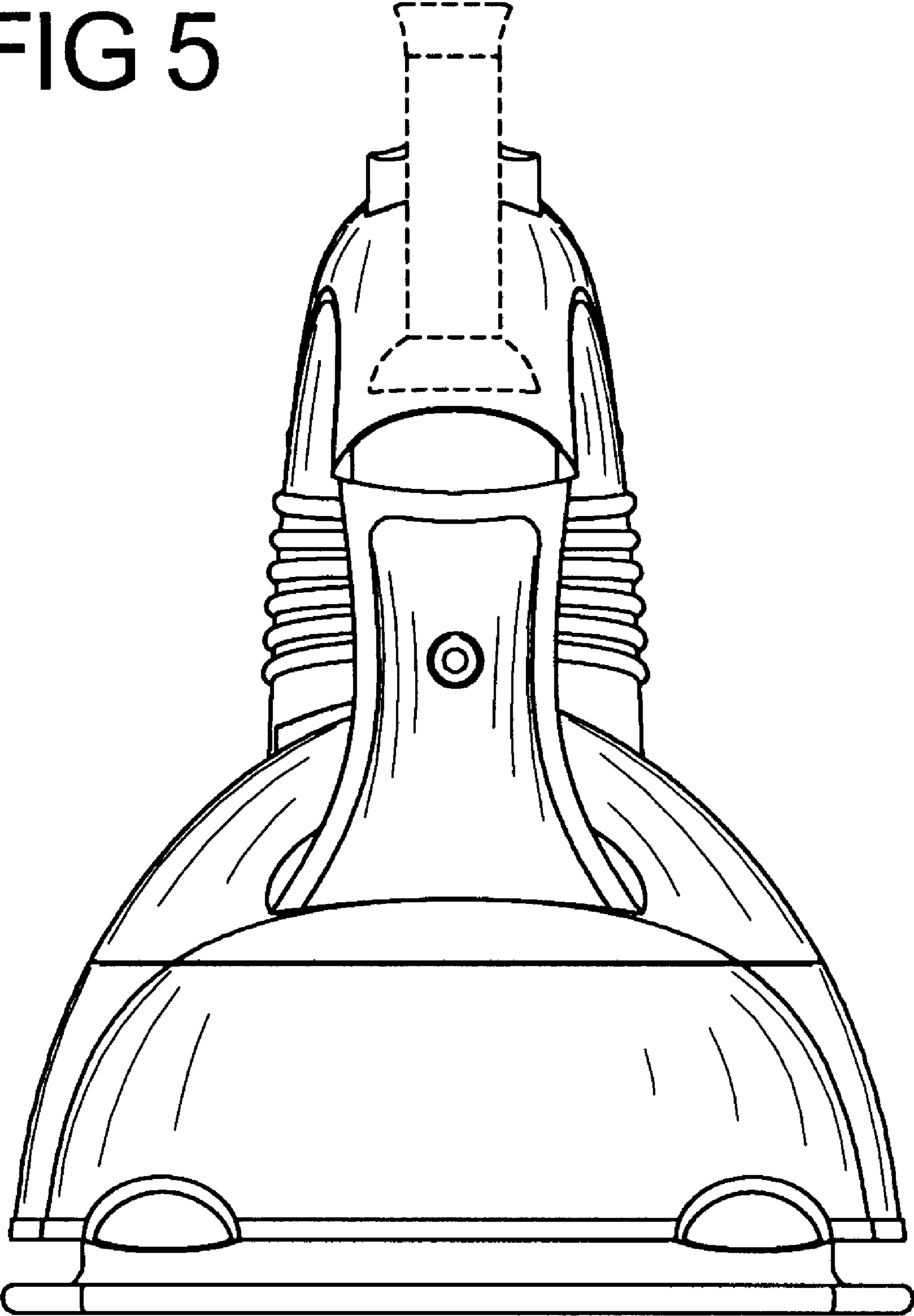

FIG 4

FIG 5



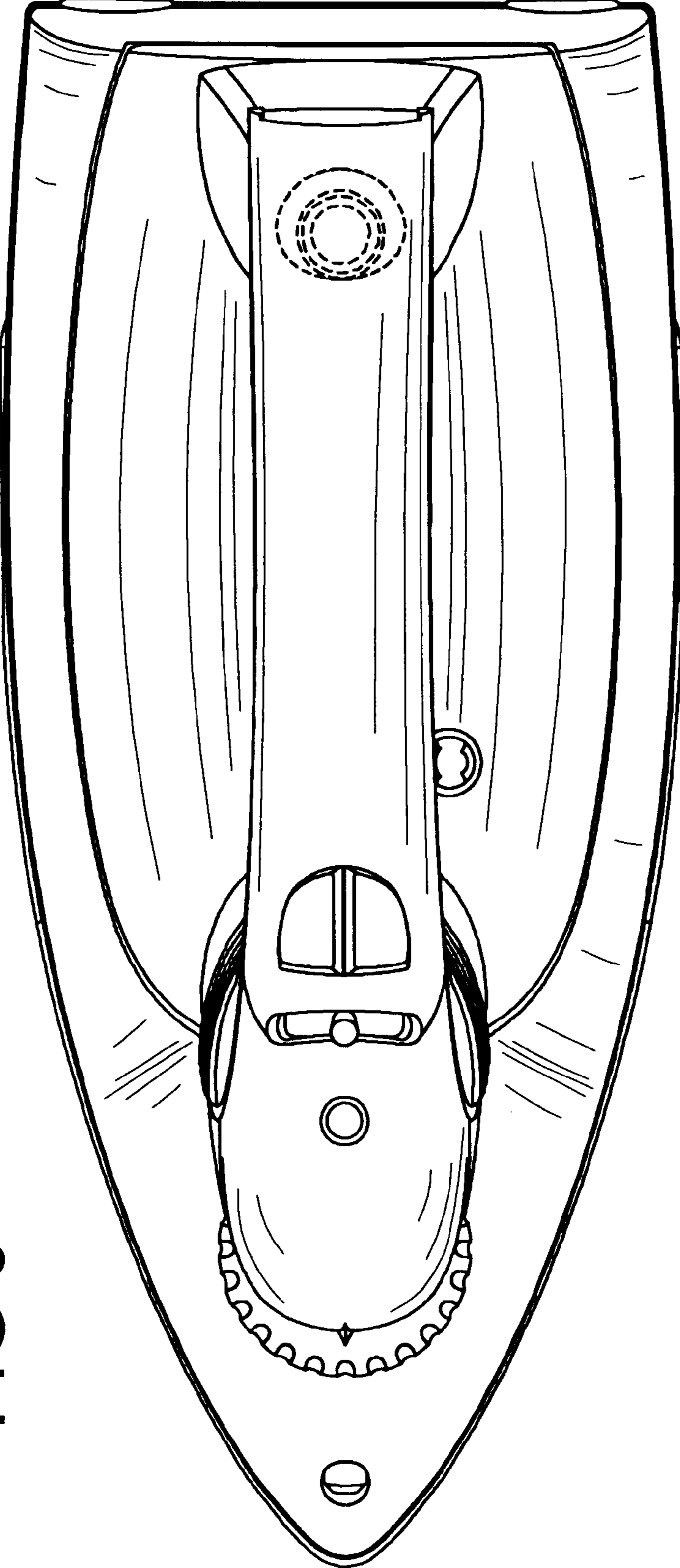

FIG 6