



US00D524462S

(12) **United States Design Patent**
Ishibashi

(10) **Patent No.:** **US D524,462 S**
(45) **Date of Patent:** **** Jul. 4, 2006**

(54) **FRONT COMBINATION LAMP FOR
AUTOMOBILE**

(75) Inventor: **Takuya Ishibashi**, Toyota (JP)

(73) Assignee: **Toyota Jidosha Kabushiki Kaisha**,
Aichi-ken (JP)

(**) Term: **14 Years**

(21) Appl. No.: **29/216,366**

(22) Filed: **Nov. 3, 2004**

(51) **LOC (8) Cl.** **26-06**

(52) **U.S. Cl.** **D26/28**

(58) **Field of Classification Search** D26/28-36;
362/459-468, 475-478, 485-487
See application file for complete search history.

(56) **References Cited**

U.S. PATENT DOCUMENTS

D501,940 S * 2/2005 Abe D26/28
D506,843 S * 6/2005 Lin D26/28

OTHER PUBLICATIONS

Imported Cars Guide Book 2003, Model: 530i M Sports,
Mfg.: BMW, Oct. 29, 2002, p. 61.

* cited by examiner

Primary Examiner—Marcus A. Jackson
(74) *Attorney, Agent, or Firm*—Finnegan, Henderson,
Farabow, Garrett & Dunner, LLP

(57) **CLAIM**

The ornamental design for a front combination lamp for automobile, as shown and described.

DESCRIPTION

FIG. 1 is a left-front, perspective view of a front combination lamp for automobile of my new design;

FIG. 2 is a front view of my new design;

FIG. 3 is a rear view of my new design;

FIG. 4 is a top view of my new design;

FIG. 5 is a bottom view of my new design;

FIG. 6 is a left-side view of my new design; and,

FIG. 7 is a right-side view of my new design.

My design includes the mirror image of the embodiment depicted.

1 Claim, 3 Drawing Sheets

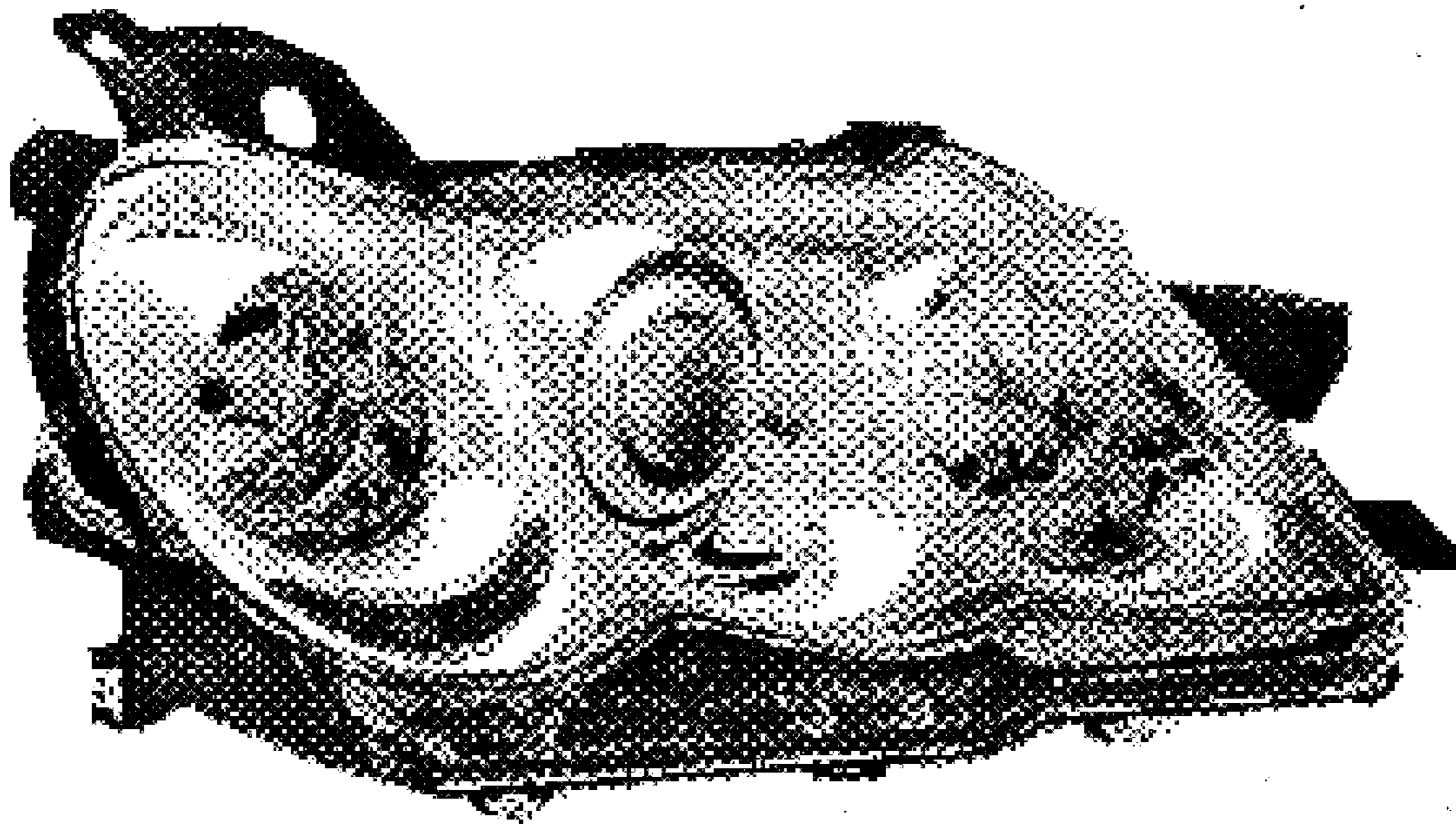

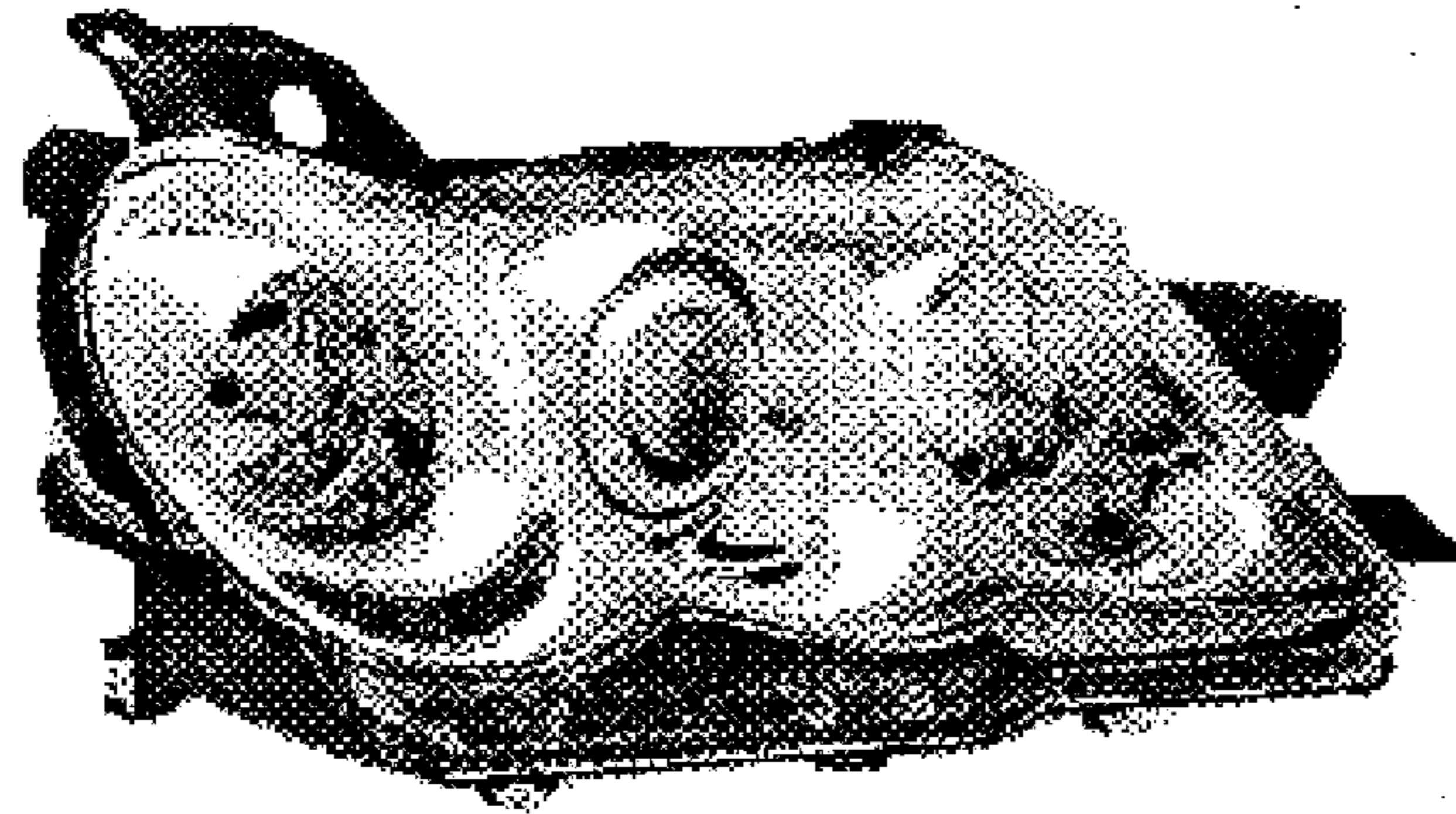

FIG. 1

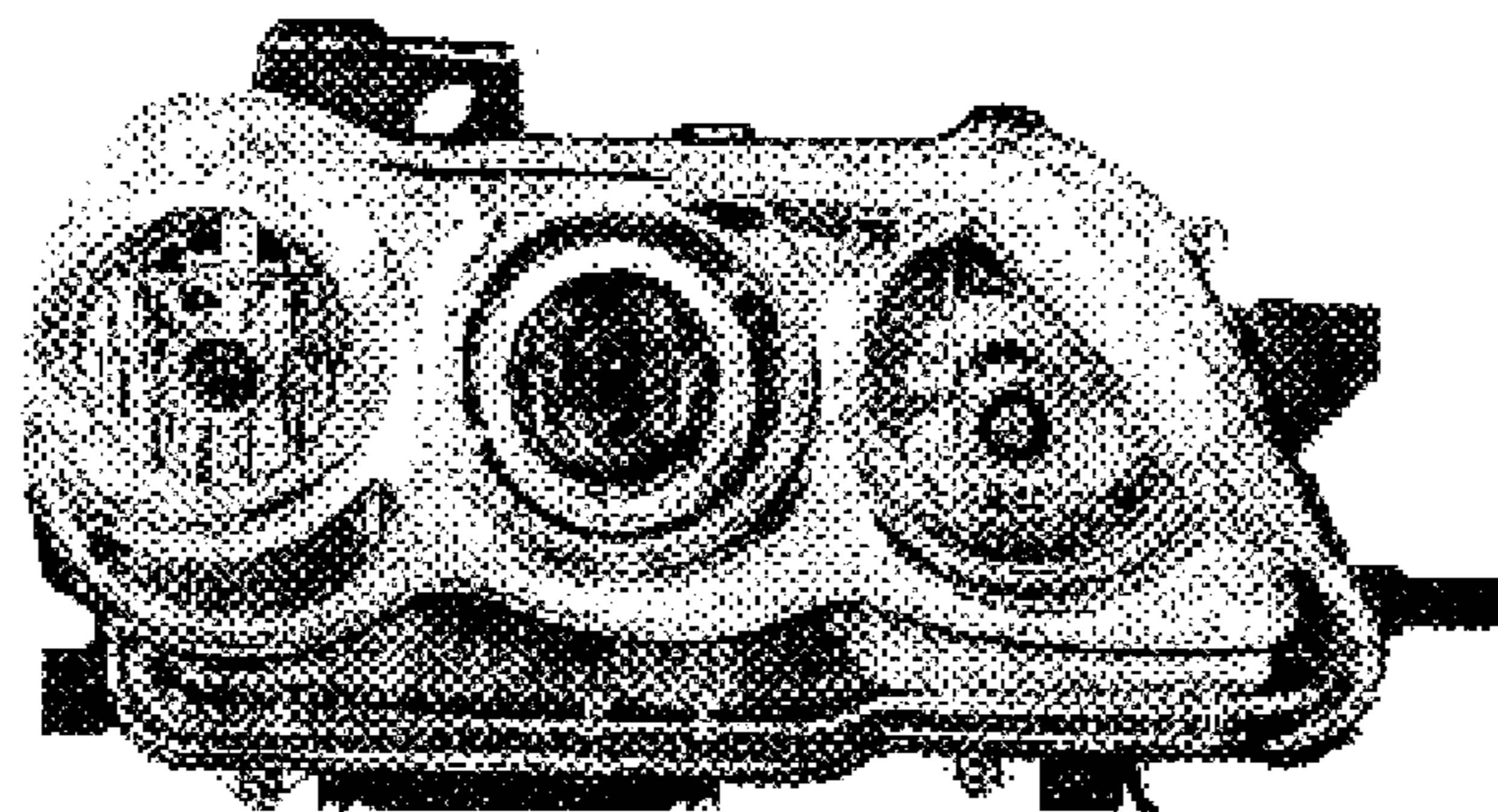

FIG. 2

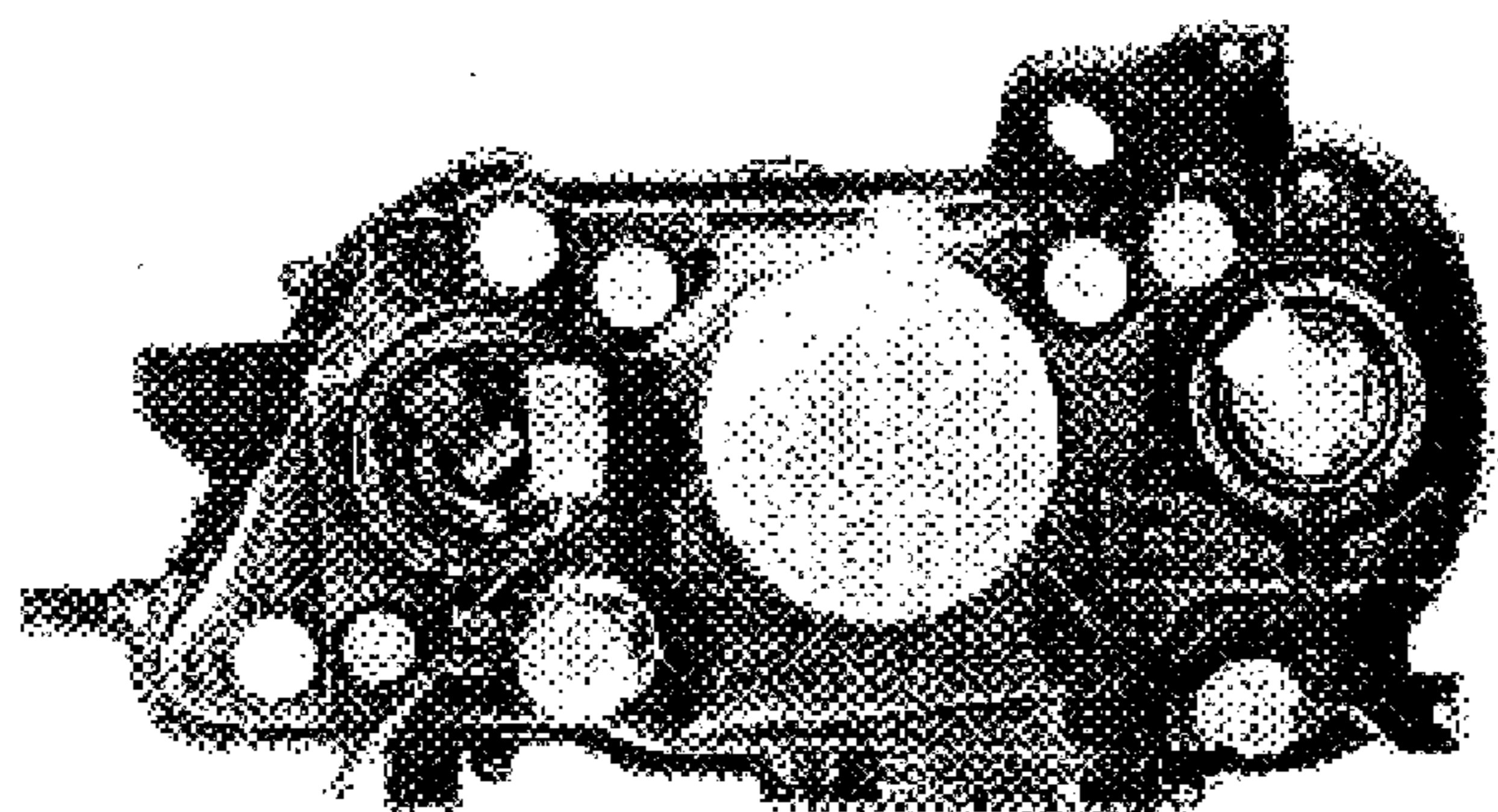

FIG. 3

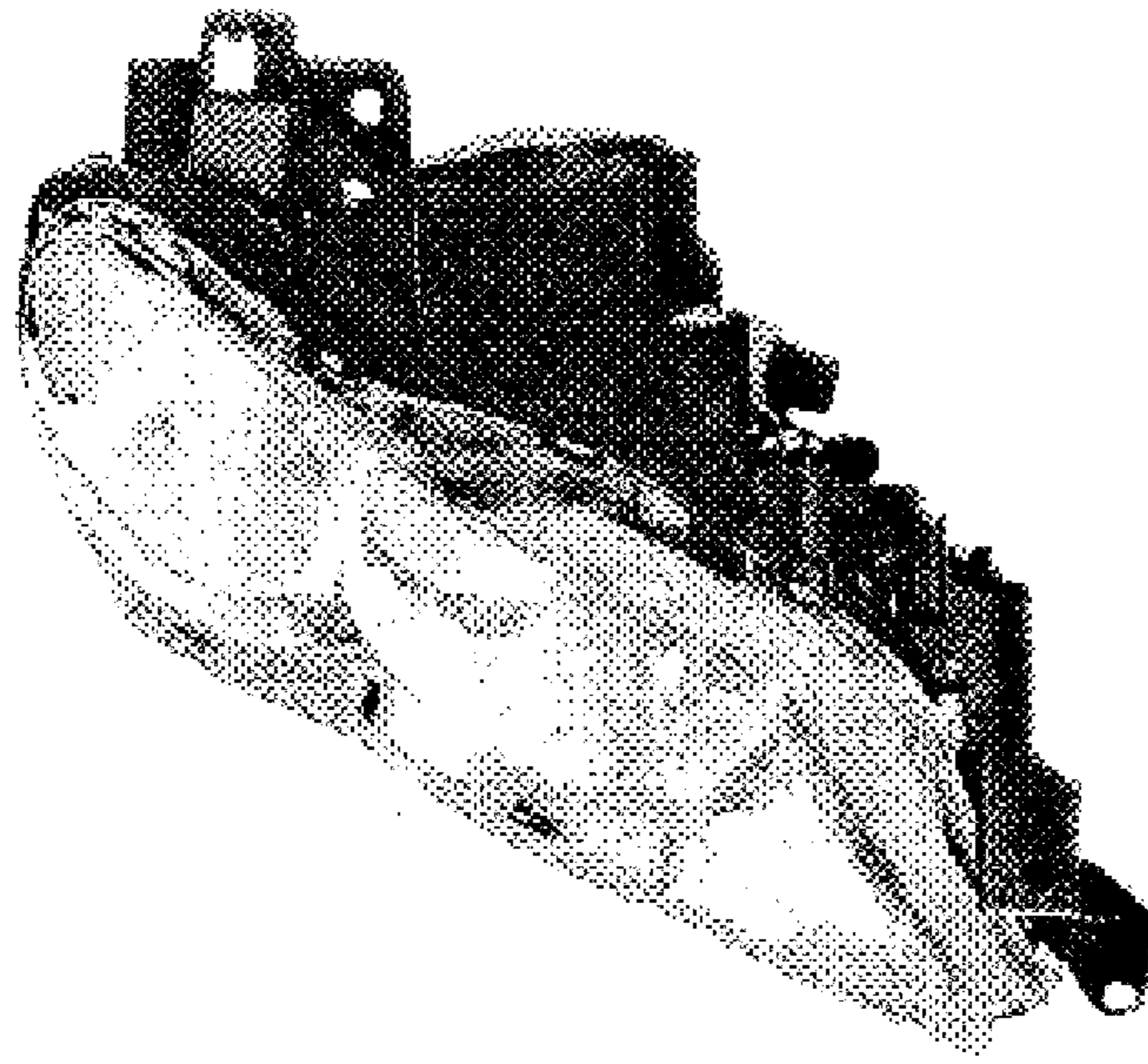

FIG. 4

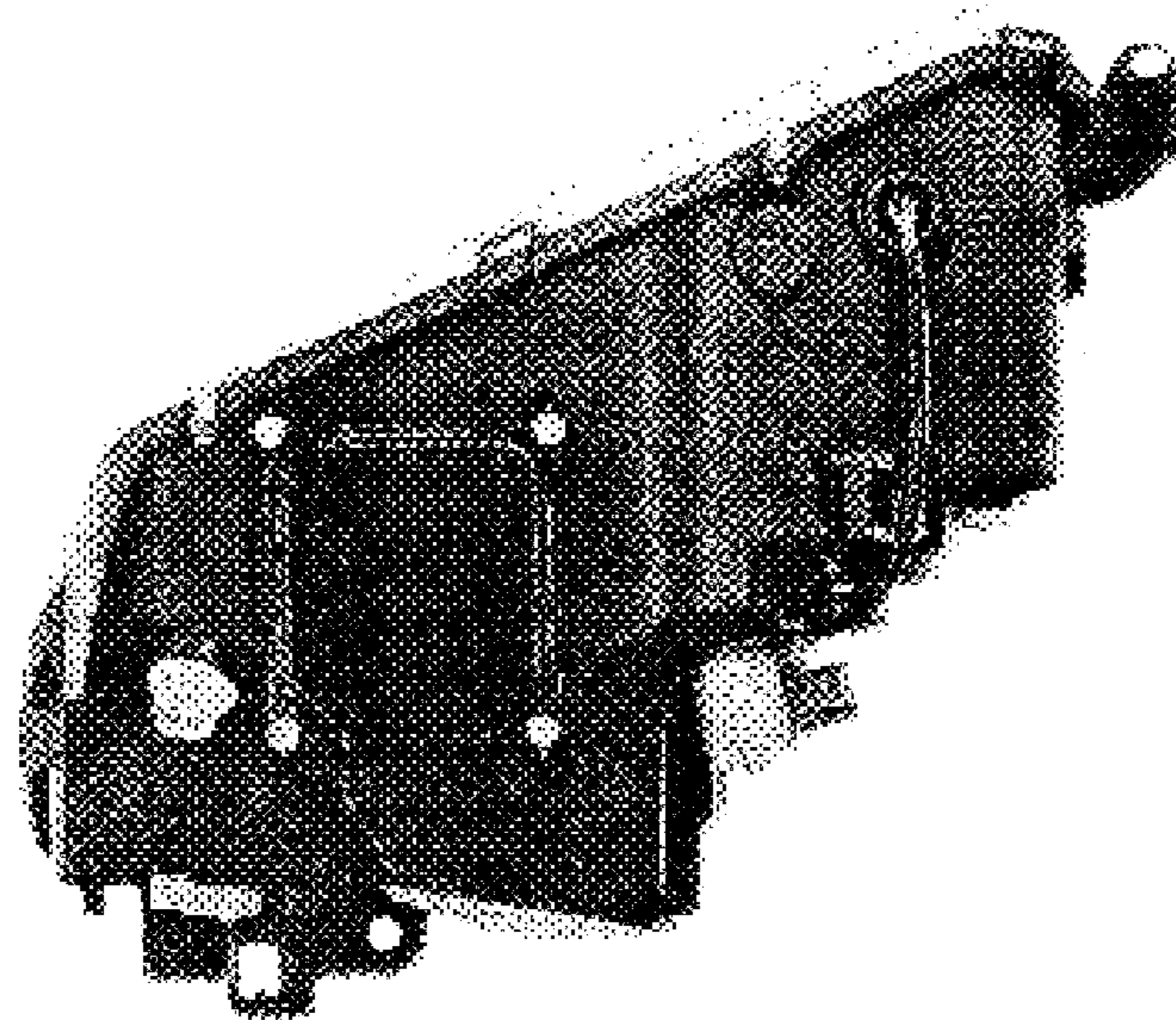

FIG. 5

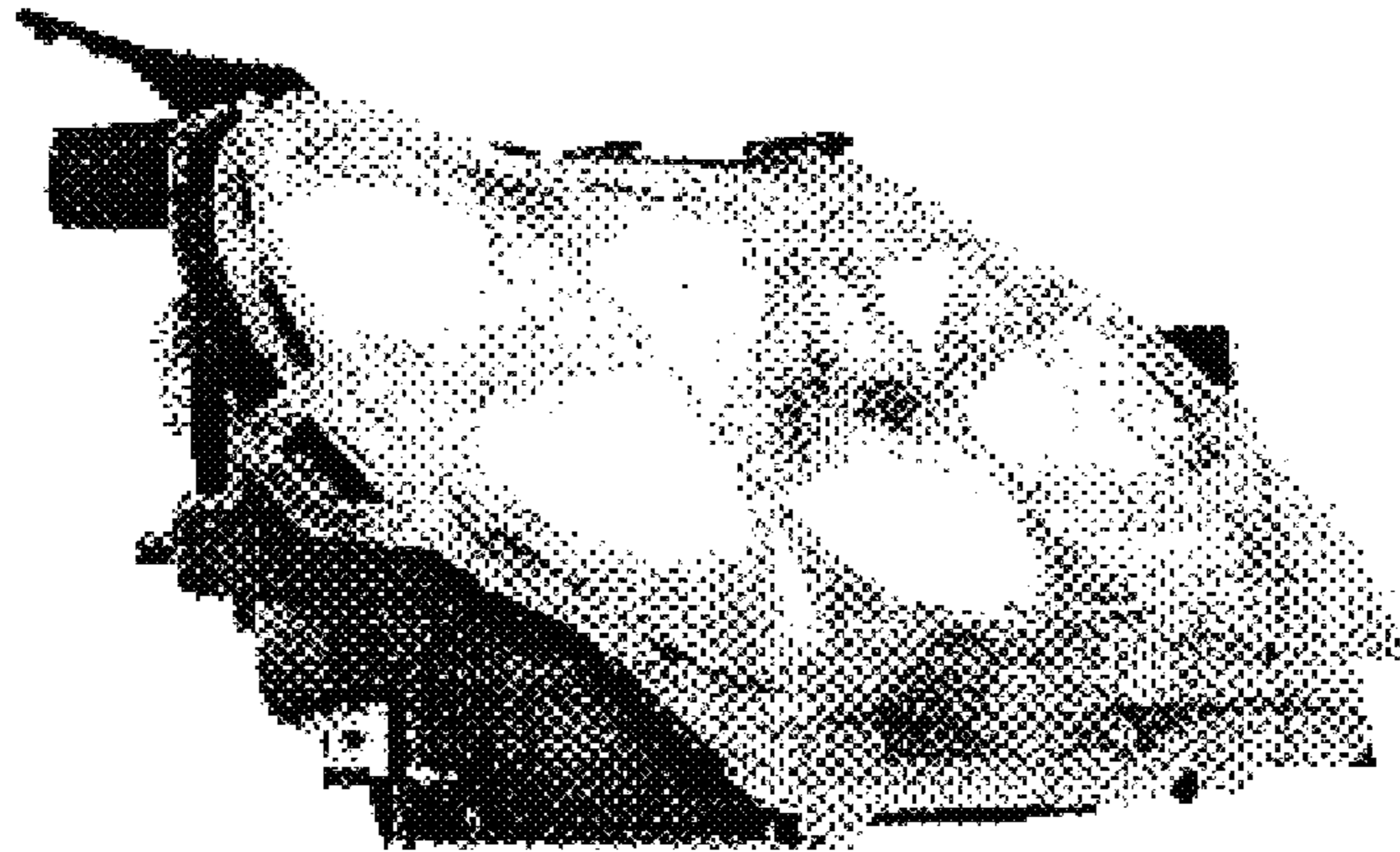

FIG. 6

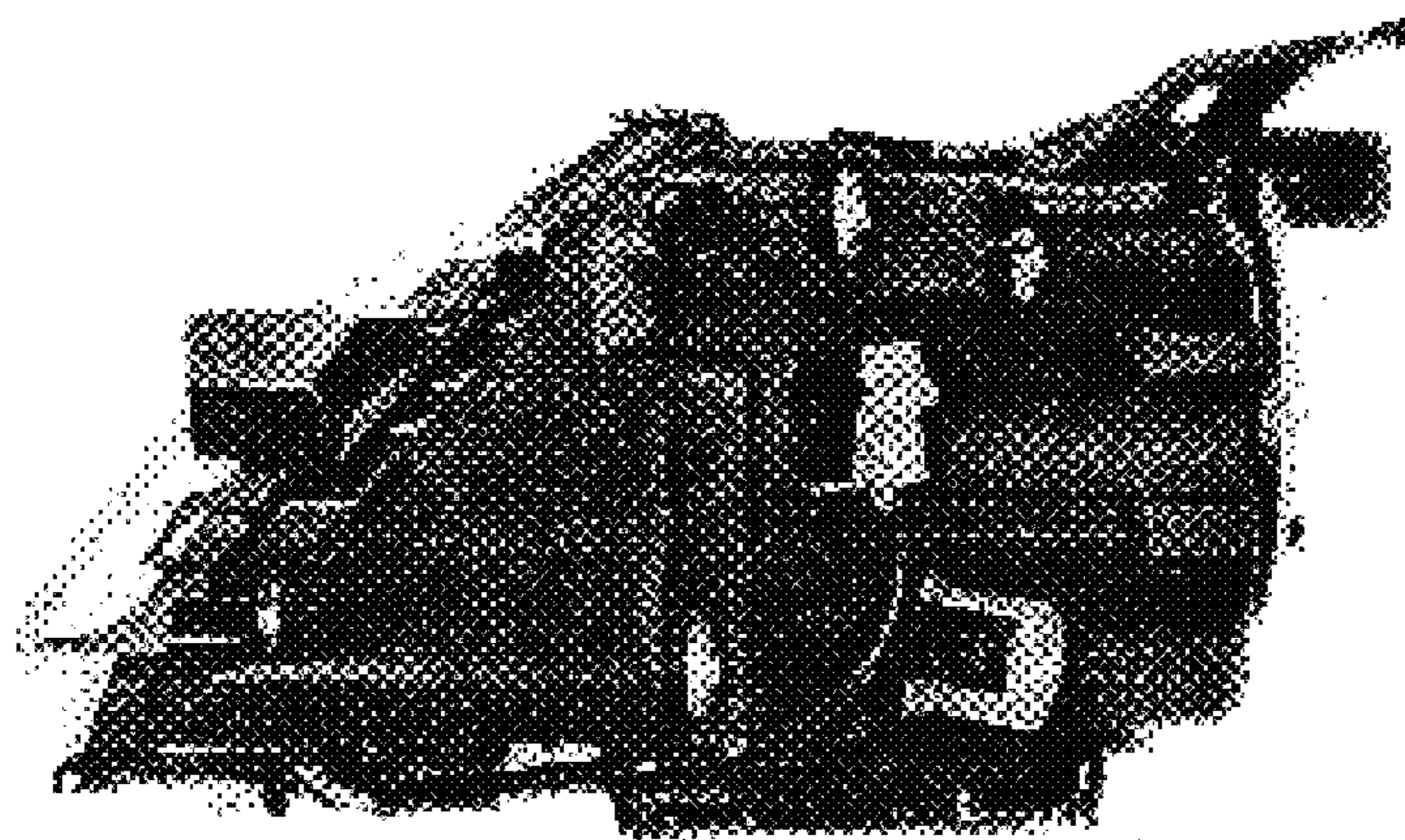

FIG. 7

UNITED STATES PATENT AND TRADEMARK OFFICE
CERTIFICATE OF CORRECTION

PATENT NO. : Des. 524,462 S
APPLICATION NO. : 29/216366
DATED : July 4, 2006
INVENTOR(S) : Takuya Ishibashi

Page 1 of 8

It is certified that error appears in the above-identified patent and that said Letters Patent is hereby corrected as shown below:

On the first page of the patent, replace the figure with the following:

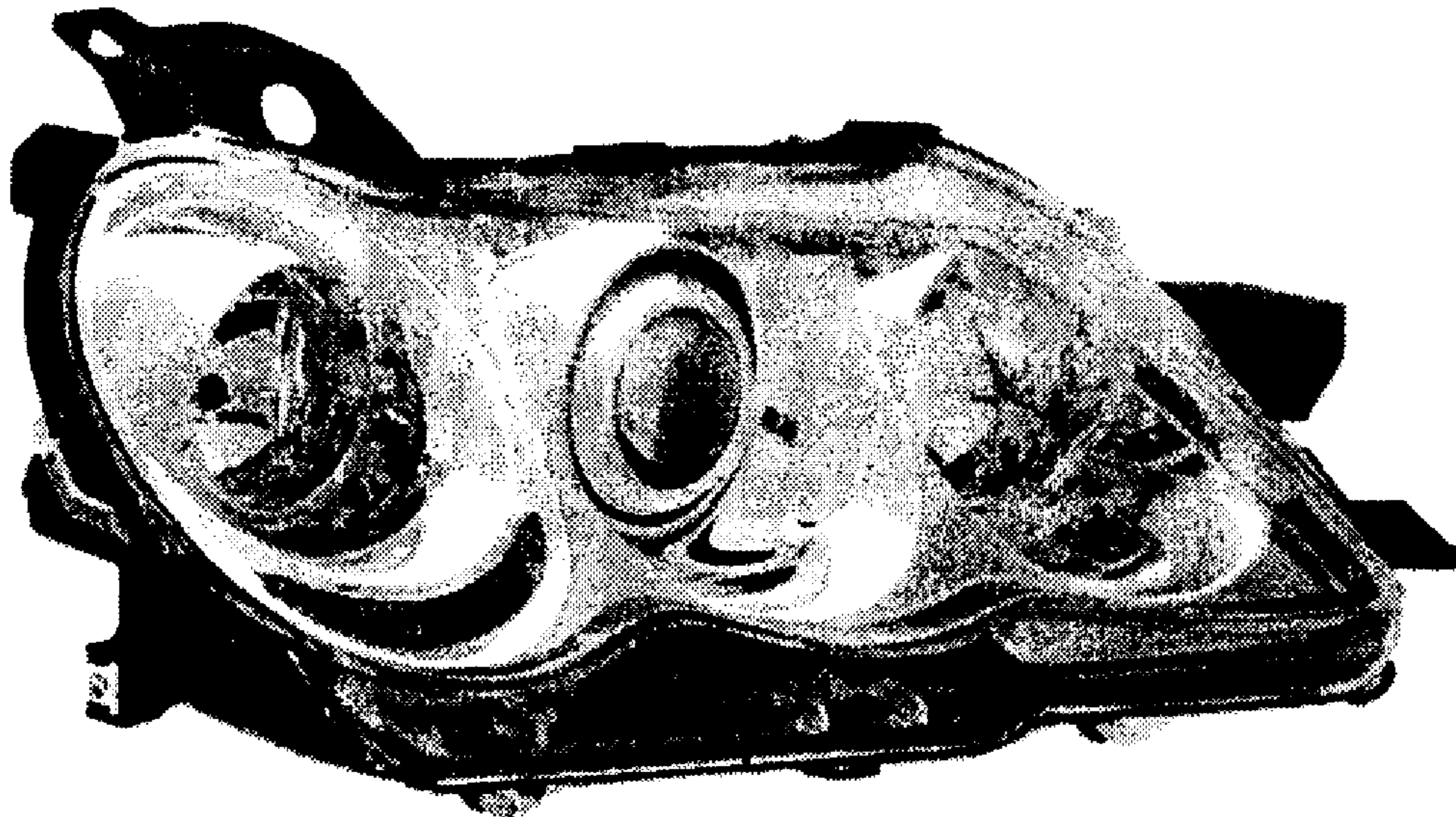

Signed and Sealed this

Nineteenth Day of February, 2008

A handwritten signature in black ink, reading "Jon W. Dudas". The signature is written in a cursive, flowing style.

JON W. DUDAS

Director of the United States Patent and Trademark Office

UNITED STATES PATENT AND TRADEMARK OFFICE
CERTIFICATE OF CORRECTION

PATENT NO. : Des. 524,462 S
APPLICATION NO. : 29/216366
DATED : July 4, 2006
INVENTOR(S) : Takuya Ishibashi

Page 2 of 8

It is certified that error appears in the above-identified patent and that said Letters Patent is hereby corrected as shown below:

On the second page of the patent, replace Fig. 1 with the following:

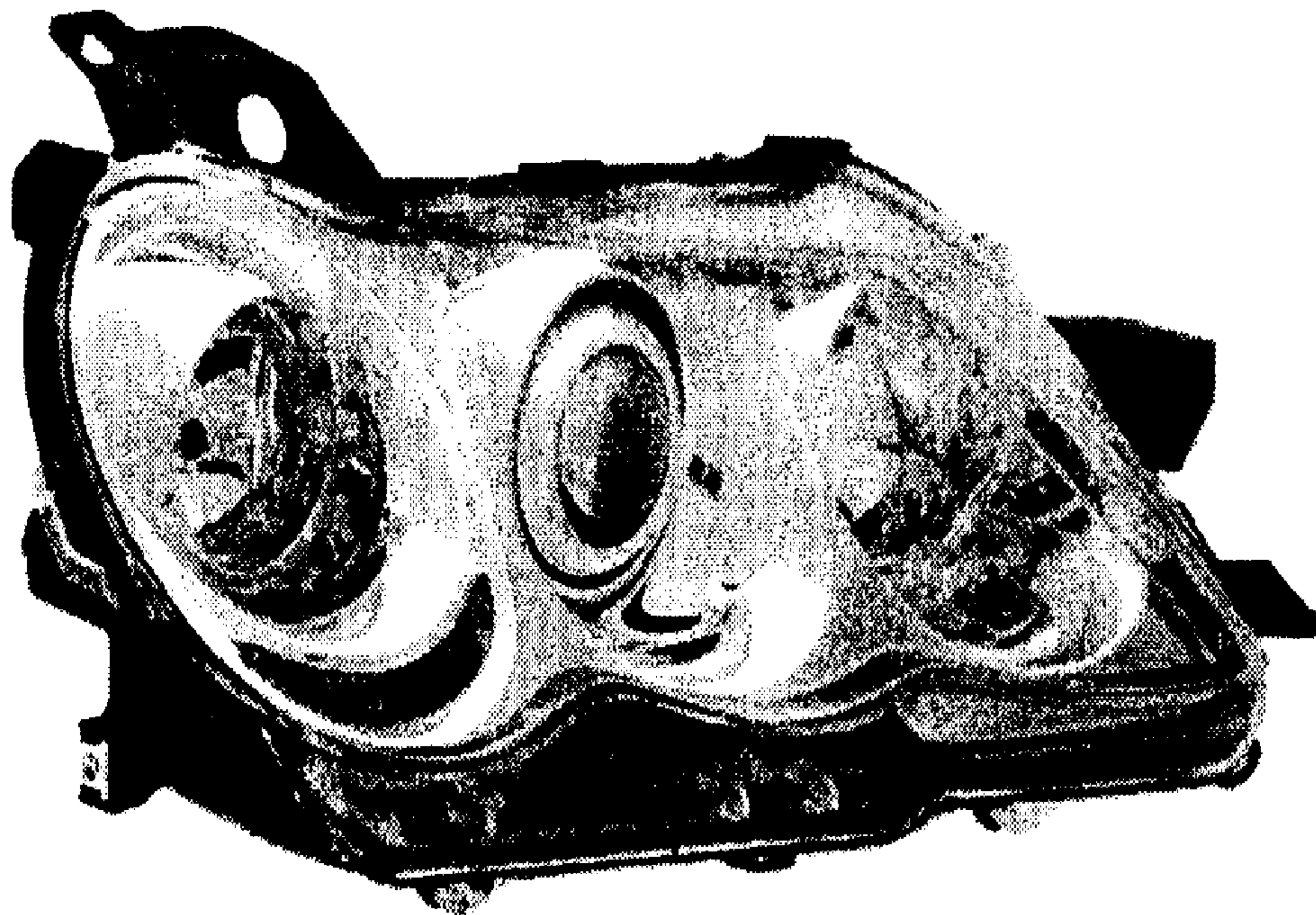

FIG. 1

UNITED STATES PATENT AND TRADEMARK OFFICE
CERTIFICATE OF CORRECTION

PATENT NO. : Des. 524,462 S
APPLICATION NO. : 29/216366
DATED : July 4, 2006
INVENTOR(S) : Takuya Ishibashi

Page 3 of 8

It is certified that error appears in the above-identified patent and that said Letters Patent is hereby corrected as shown below:

On the second page of the patent, replace Fig. 2 with the following:

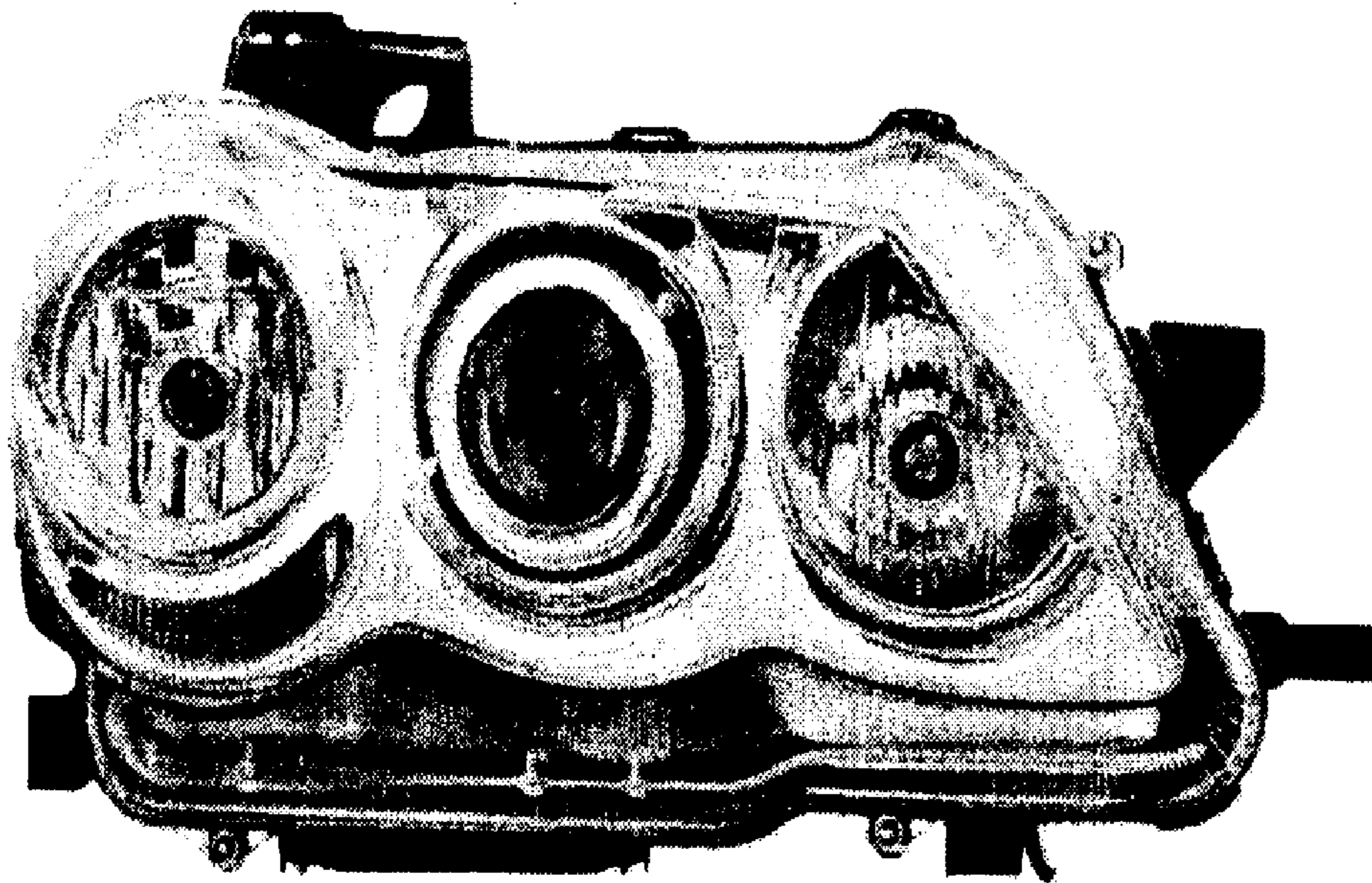

FIG. 2

UNITED STATES PATENT AND TRADEMARK OFFICE
CERTIFICATE OF CORRECTION

PATENT NO. : Des. 524,462 S
APPLICATION NO. : 29/216366
DATED : July 4, 2006
INVENTOR(S) : Takuya Ishibashi

Page 4 of 8

It is certified that error appears in the above-identified patent and that said Letters Patent is hereby corrected as shown below:

On the second page of the patent, replace Fig. 3 with the following:

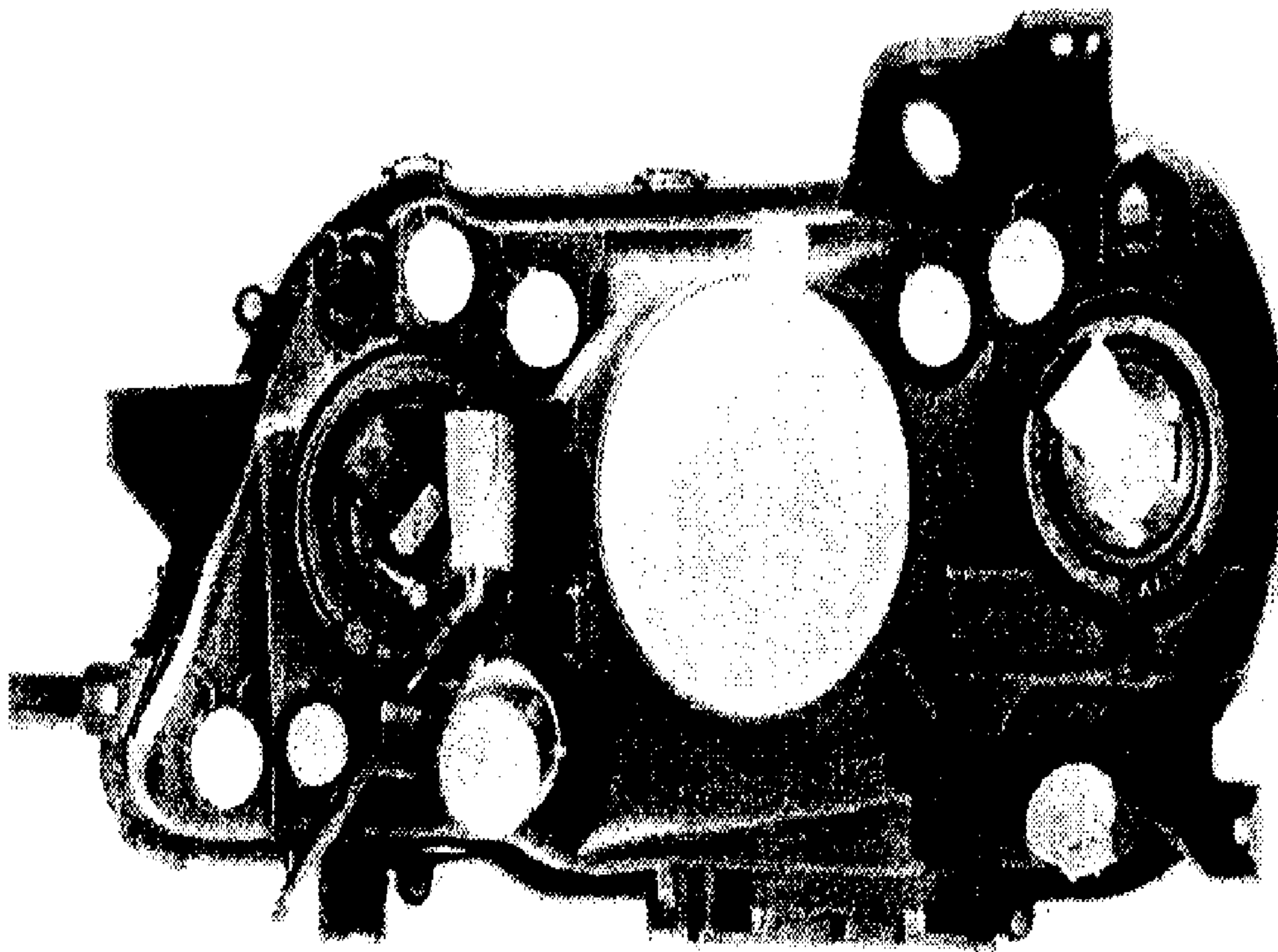

FIG. 3

UNITED STATES PATENT AND TRADEMARK OFFICE
CERTIFICATE OF CORRECTION

PATENT NO. : Des. 524,462 S
APPLICATION NO. : 29/216366
DATED : July 4, 2006
INVENTOR(S) : Takuya Ishibashi

Page 5 of 8

It is certified that error appears in the above-identified patent and that said Letters Patent is hereby corrected as shown below:

On the third page of the patent, replace Fig. 4 with the following:

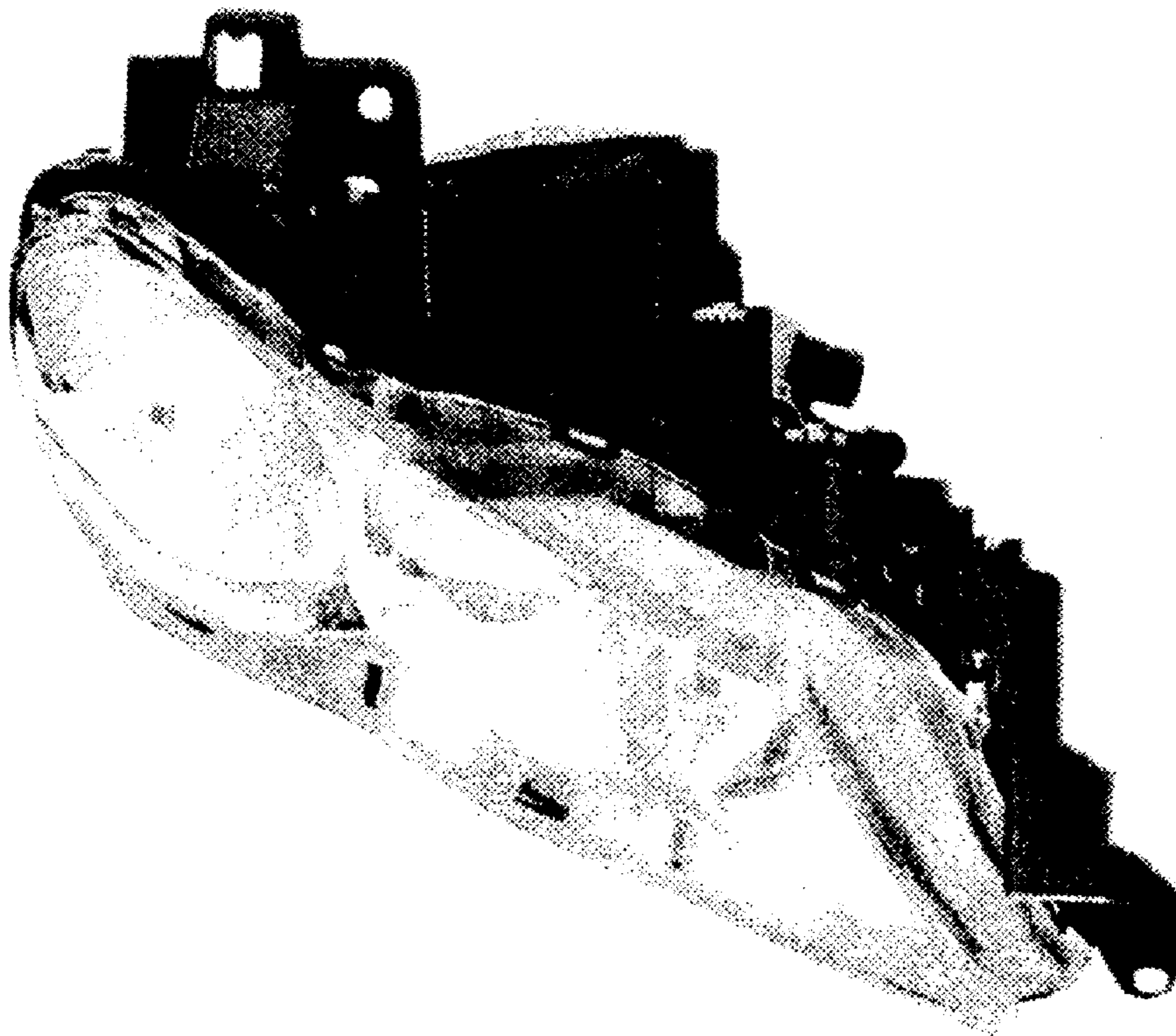

FIG. 4

UNITED STATES PATENT AND TRADEMARK OFFICE
CERTIFICATE OF CORRECTION

PATENT NO. : Des. 524,462 S
APPLICATION NO. : 29/216366
DATED : July 4, 2006
INVENTOR(S) : Takuya Ishibashi

Page 6 of 8

It is certified that error appears in the above-identified patent and that said Letters Patent is hereby corrected as shown below:

On the third page of the patent, replace Fig. 5 with the following:

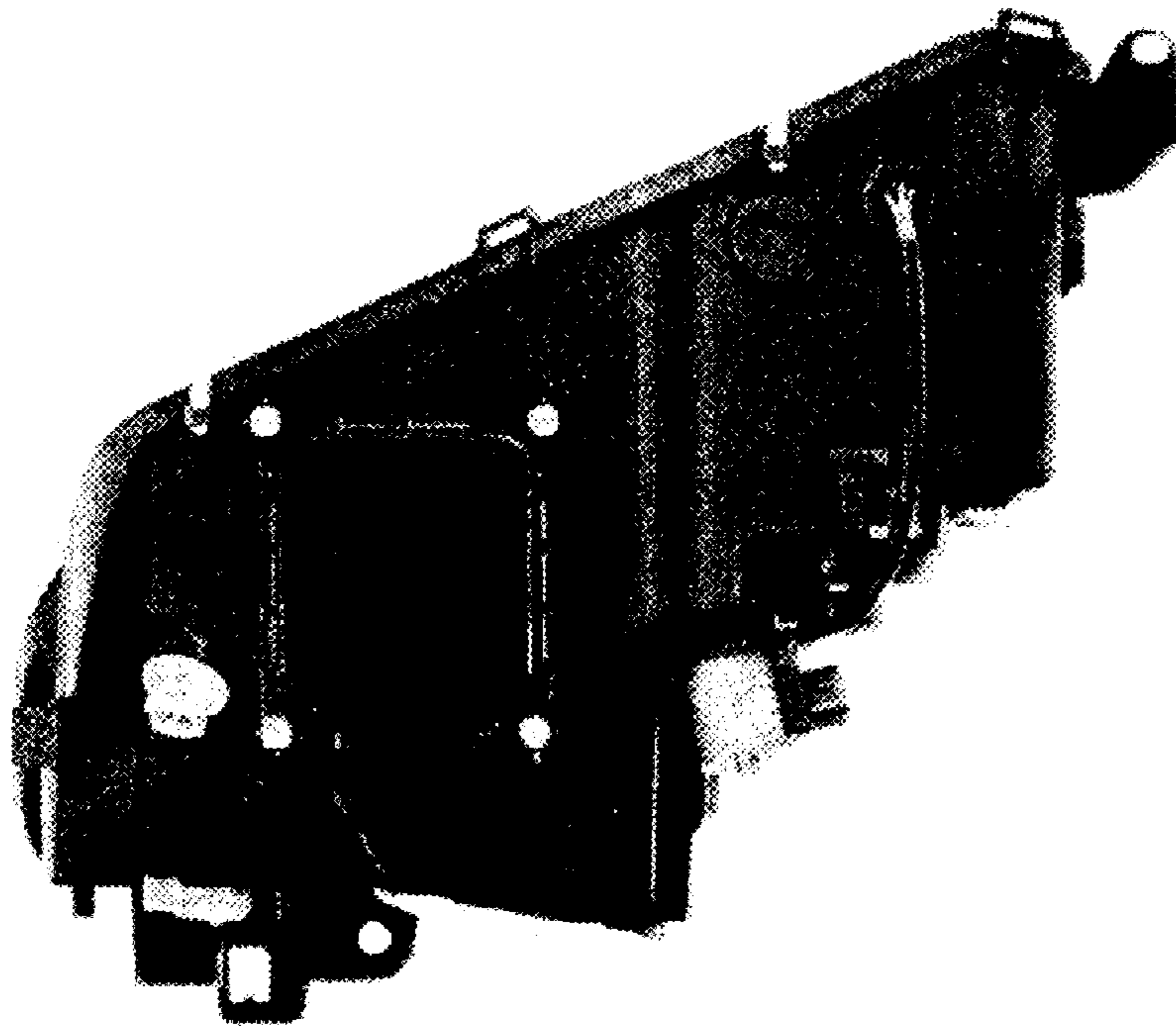

FIG. 5

UNITED STATES PATENT AND TRADEMARK OFFICE
CERTIFICATE OF CORRECTION

PATENT NO. : Des. 524,462 S
APPLICATION NO. : 29/216366
DATED : July 4, 2006
INVENTOR(S) : Takuya Ishibashi

Page 7 of 8

It is certified that error appears in the above-identified patent and that said Letters Patent is hereby corrected as shown below:

On the fourth page of the patent, replace Fig. 6 with the following:

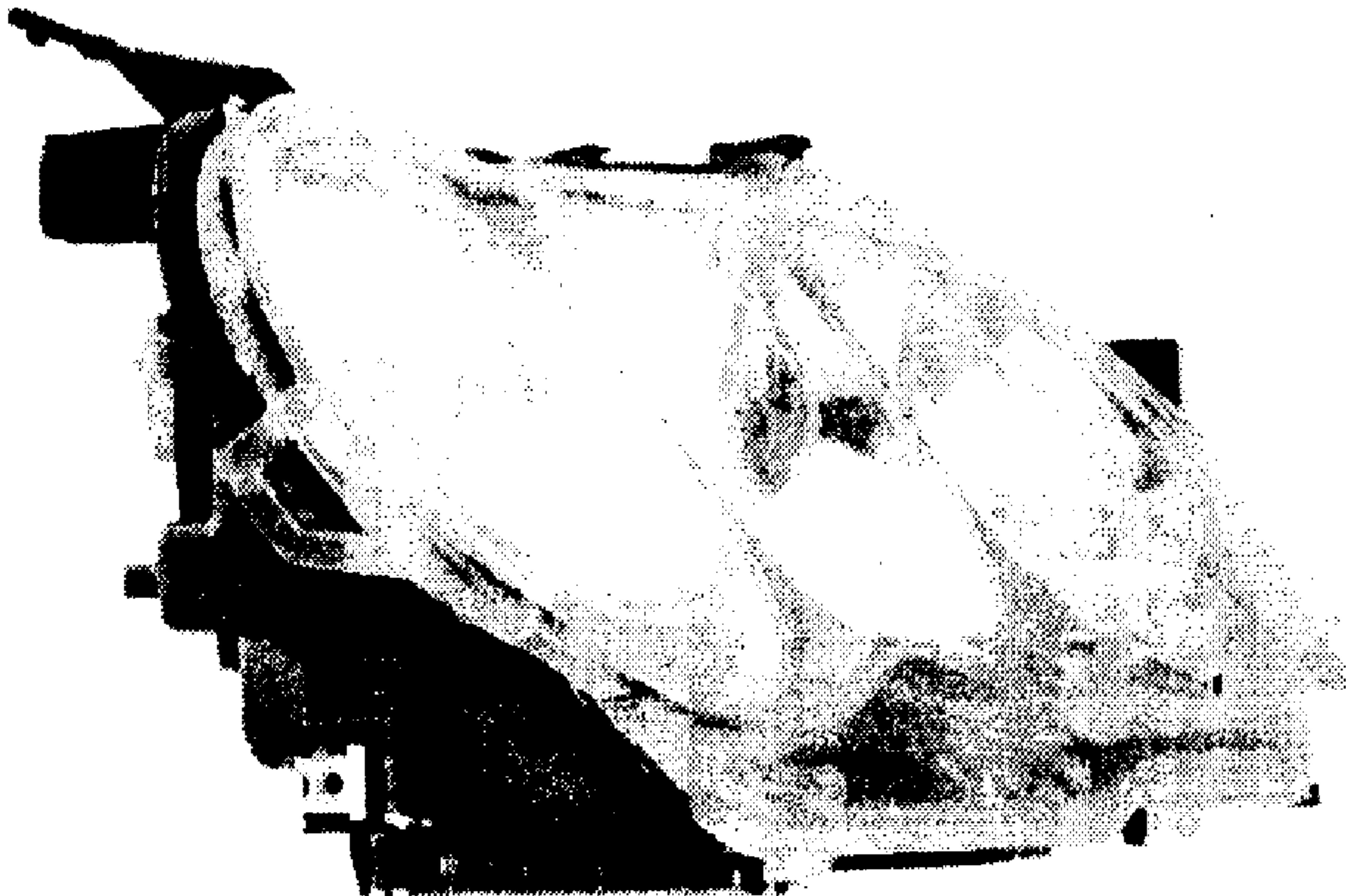

FIG. 6

UNITED STATES PATENT AND TRADEMARK OFFICE
CERTIFICATE OF CORRECTION

PATENT NO. : Des. 524,462 S
APPLICATION NO. : 29/216366
DATED : July 4, 2006
INVENTOR(S) : Takuya Ishibashi

Page 8 of 8

It is certified that error appears in the above-identified patent and that said Letters Patent is hereby corrected as shown below:

On the fourth page of the patent, replace Fig. 7 with the following:

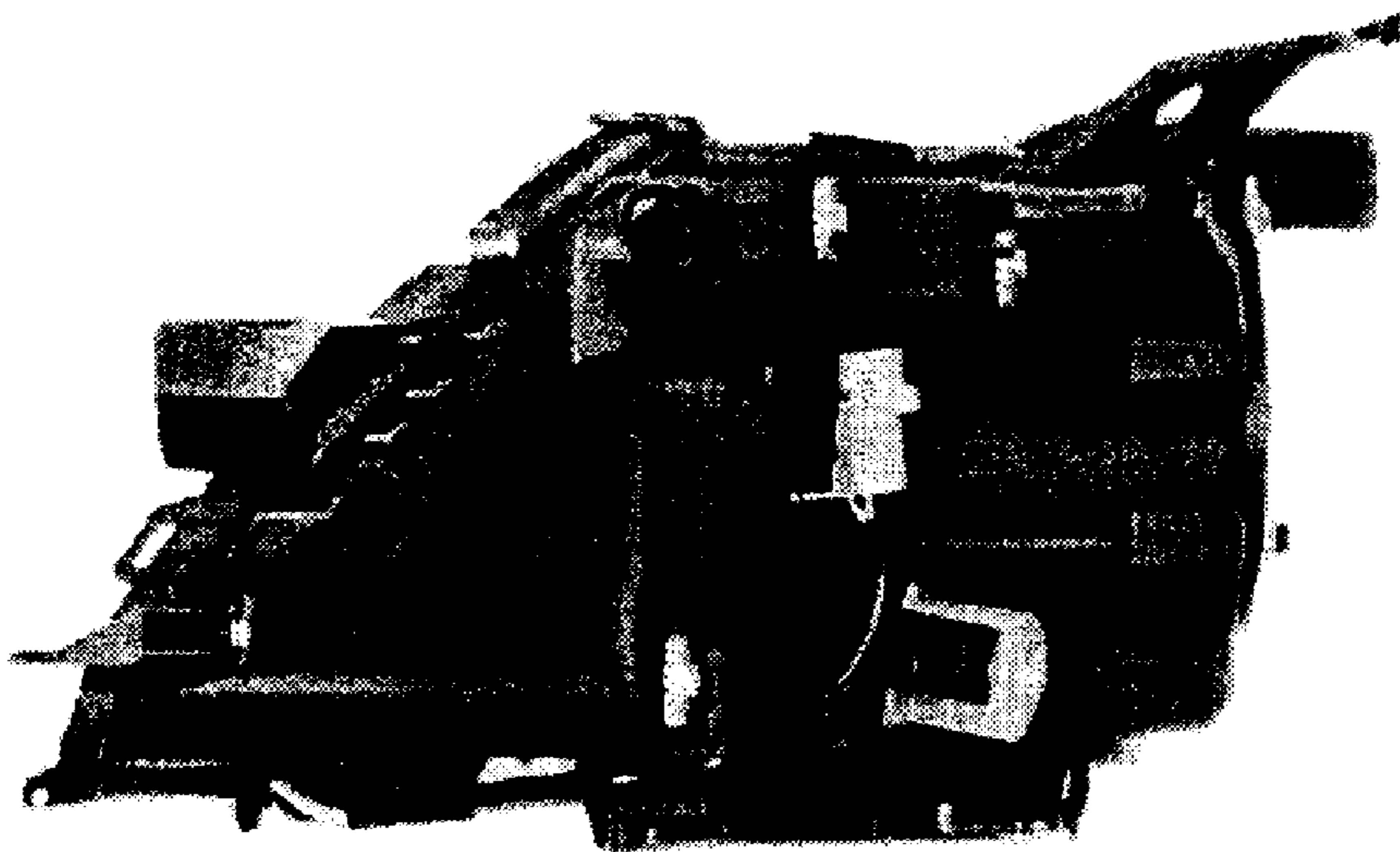

Fig. 7

UNITED STATES PATENT AND TRADEMARK OFFICE
CERTIFICATE OF CORRECTION

PATENT NO. : Des. 524,462 S
APPLICATION NO. : 29/216366
DATED : July 4, 2006
INVENTOR(S) : Takuya Ishibashi

Page 1 of 9

It is certified that error appears in the above-identified patent and that said Letters Patent is hereby corrected as shown below:

Delete the title page and substitute therefor the attached title page.

This certificate supersedes the Certificate of Correction issued February 19, 2008.

Signed and Sealed this

Eleventh Day of March, 2008

A handwritten signature in black ink that reads "Jon W. Dudas". The signature is written in a cursive style with a large initial "J" and "D".

JON W. DUDAS

Director of the United States Patent and Trademark Office

(12) **United States Design Patent** (10) **Patent No.:** **US D524,462 S**
Ishibashi (45) **Date of Patent:** **** Jul. 4, 2006**

(54) **FRONT COMBINATION LAMP FOR
AUTOMOBILE**

(75) **Inventor:** **Takuyn Ishibashi, Toyota (JP)**

(73) **Assignee:** **Toyota Jidosha Kabushiki Kaisha,
Aichi-ken (JP)**

(**) **Term:** **14 Years**

(21) **Appl. No.:** **29/216,366**

(22) **Filed:** **Nov. 3, 2004**

(51) **LOC (8) Cl.** **26-06**

(52) **U.S. Cl.** **D26/28**

(58) **Field of Classification Search** **D26/28-36;**
362/459-468, 475-478, 485-487
See application file for complete search history.

(56) **References Cited**

U.S. PATENT DOCUMENTS

D501,940 S * 2/2005 Abe D26/28
D506,843 S * 6/2005 Lin D26/28

OTHER PUBLICATIONS

Imported Cars Guide Book 2003, Model: 530i M Sports,
Mfg.: BMW, Oct. 29, 2002, p. 61.

* cited by examiner

Primary Examiner—Marcus A. Jackson
(74) Attorney, Agent, or Firm—Finnegan, Henderson,
Farabow, Garrett & Dunner, LLP

(57) **CLAIM**

The ornamental design for a front combination lamp for automobile, as shown and described.

DESCRIPTION

FIG. 1 is a left-front, perspective view of a front combination lamp for automobile of my new design;

FIG. 2 is a front view of my new design;

FIG. 3 is a rear view of my new design;

FIG. 4 is a top view of my new design;

FIG. 5 is a bottom view of my new design;

FIG. 6 is a left-side view of my new design; and,

FIG. 7 is a right-side view of my new design.

My design includes the mirror image of the embodiment depicted.

1 Claim, 3 Drawing Sheets



UNITED STATES PATENT AND TRADEMARK OFFICE
CERTIFICATE OF CORRECTION

PATENT NO. : Des. 524,462 S
APPLICATION NO. : 29/216366
DATED : July 4, 2006
INVENTOR(S) : Takuya Ishibashi

Page 3 of 9

It is certified that error appears in the above-identified patent and that said Letters Patent is hereby corrected as shown below:

On Drawing Sheet 1 of 3 of the patent, replace Fig. 1 with the following:

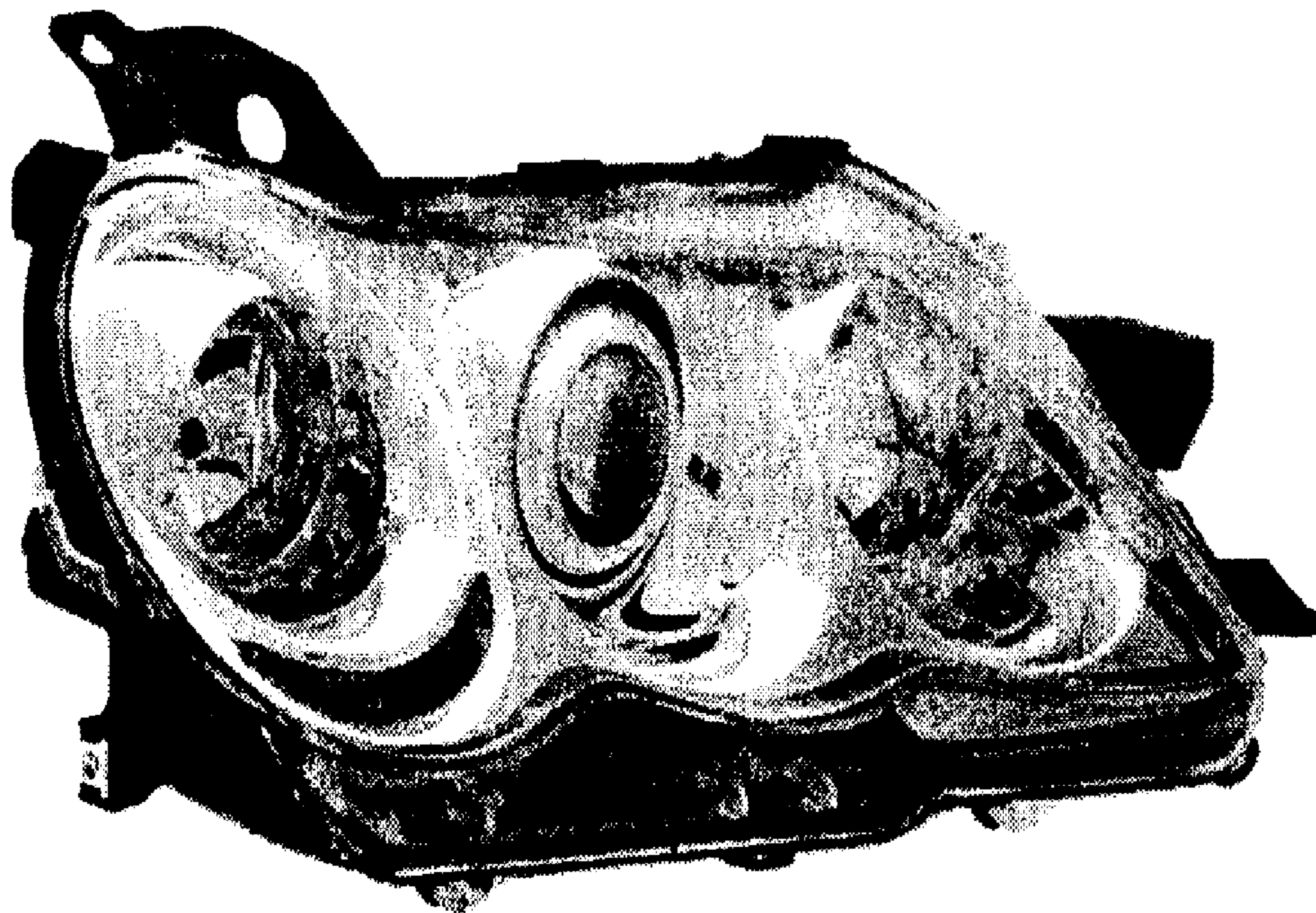

FIG. 1

UNITED STATES PATENT AND TRADEMARK OFFICE
CERTIFICATE OF CORRECTION

PATENT NO. : Des. 524,462 S
APPLICATION NO. : 29/216366
DATED : July 4, 2006
INVENTOR(S) : Takuya Ishibashi

Page 4 of 9

It is certified that error appears in the above-identified patent and that said Letters Patent is hereby corrected as shown below:

On Drawing Sheet 1 of 3 of the patent, replace Fig. 2 with the following:

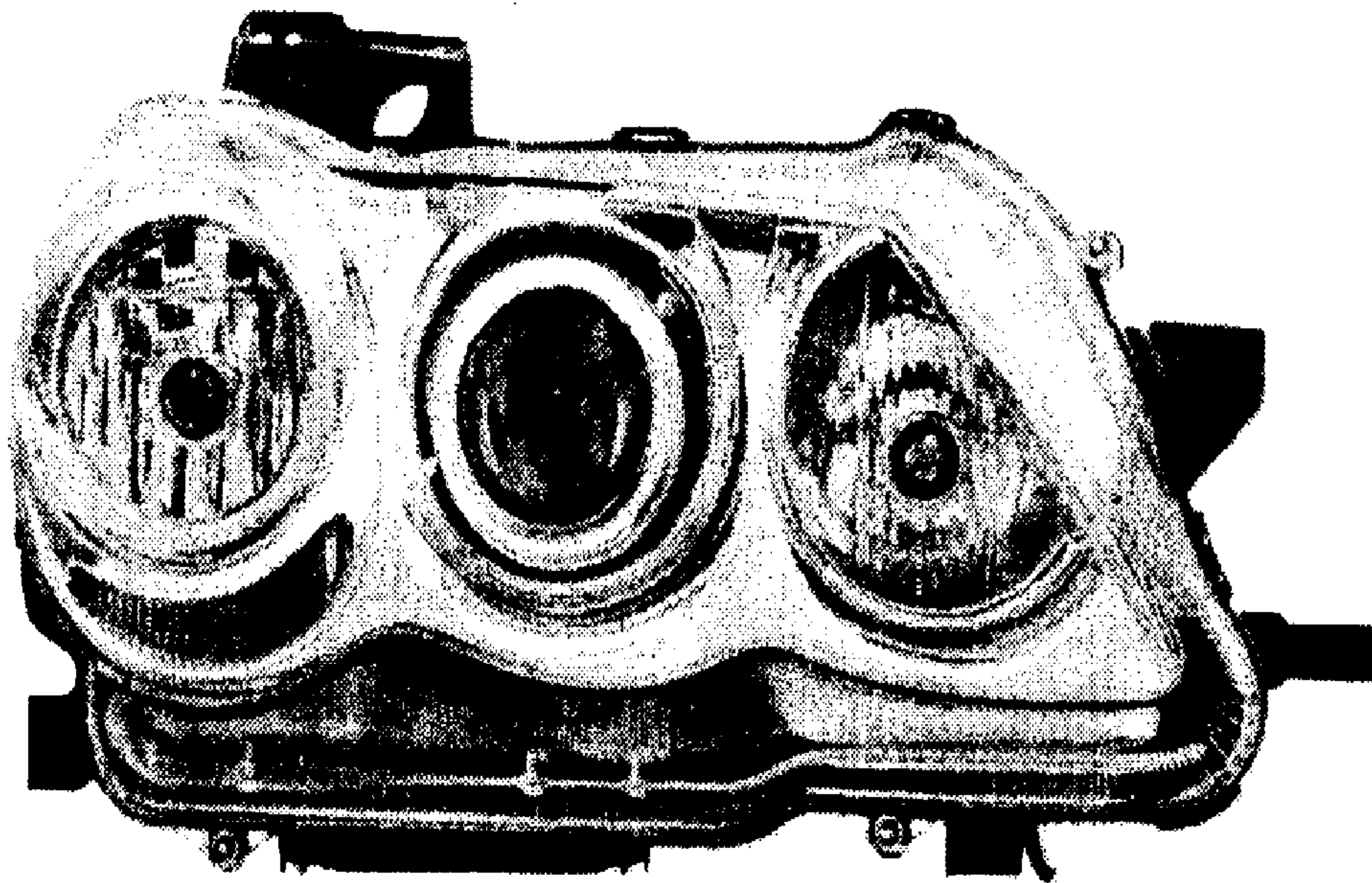

FIG. 2

UNITED STATES PATENT AND TRADEMARK OFFICE
CERTIFICATE OF CORRECTION

PATENT NO. : Des. 524,462 S
APPLICATION NO. : 29/216366
DATED : July 4, 2006
INVENTOR(S) : Takuya Ishibashi

Page 5 of 9

It is certified that error appears in the above-identified patent and that said Letters Patent is hereby corrected as shown below:

On Drawing Sheet 1 of 3 of the patent, replace Fig. 3 with the following:

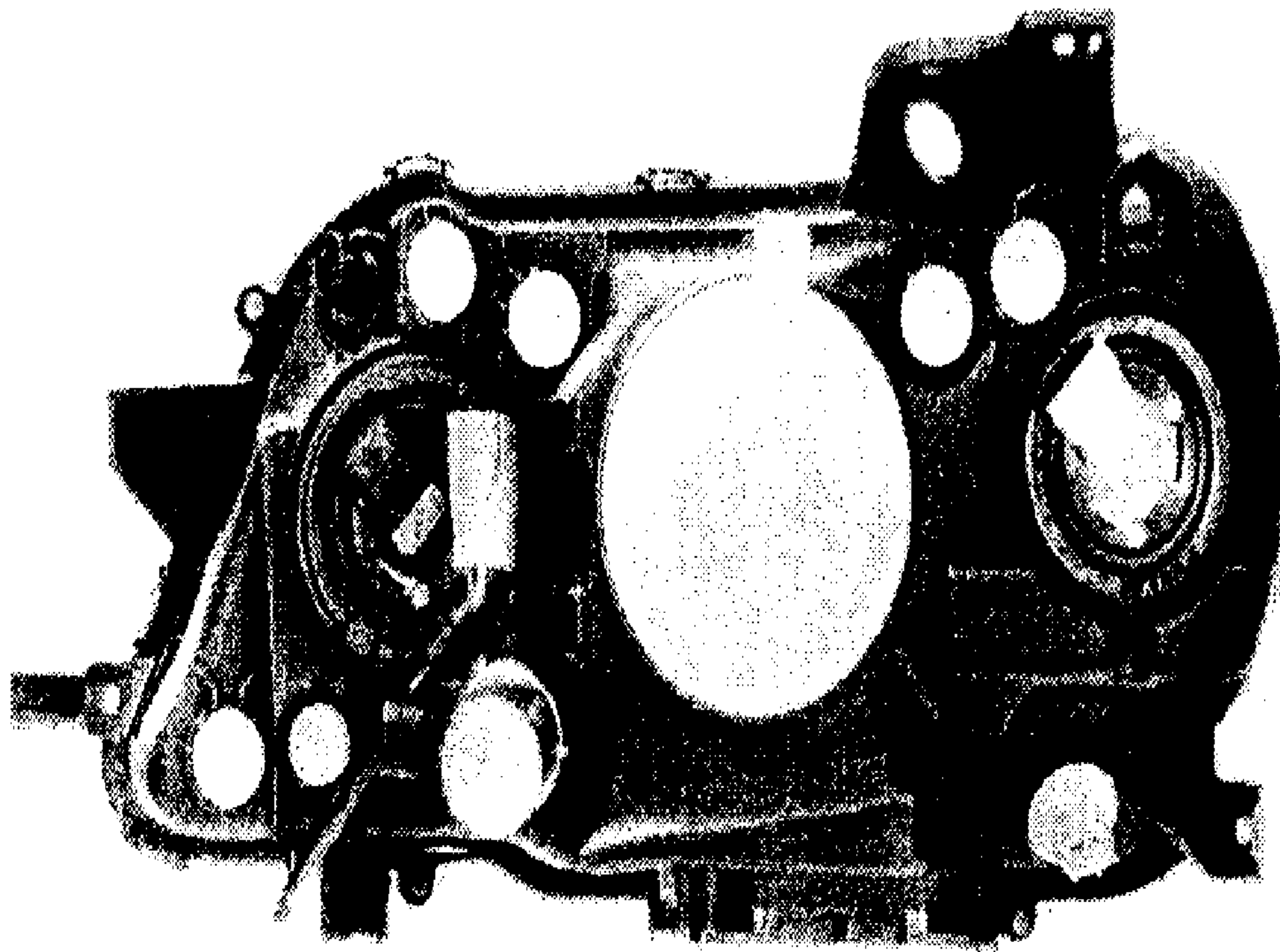

FIG. 3

UNITED STATES PATENT AND TRADEMARK OFFICE
CERTIFICATE OF CORRECTION

PATENT NO. : Des. 524,462 S
APPLICATION NO. : 29/216366
DATED : July 4, 2006
INVENTOR(S) : Takuya Ishibashi

Page 6 of 9

It is certified that error appears in the above-identified patent and that said Letters Patent is hereby corrected as shown below:

On Drawing Sheet 2 of 3 of the patent, replace Fig. 4 with the following:

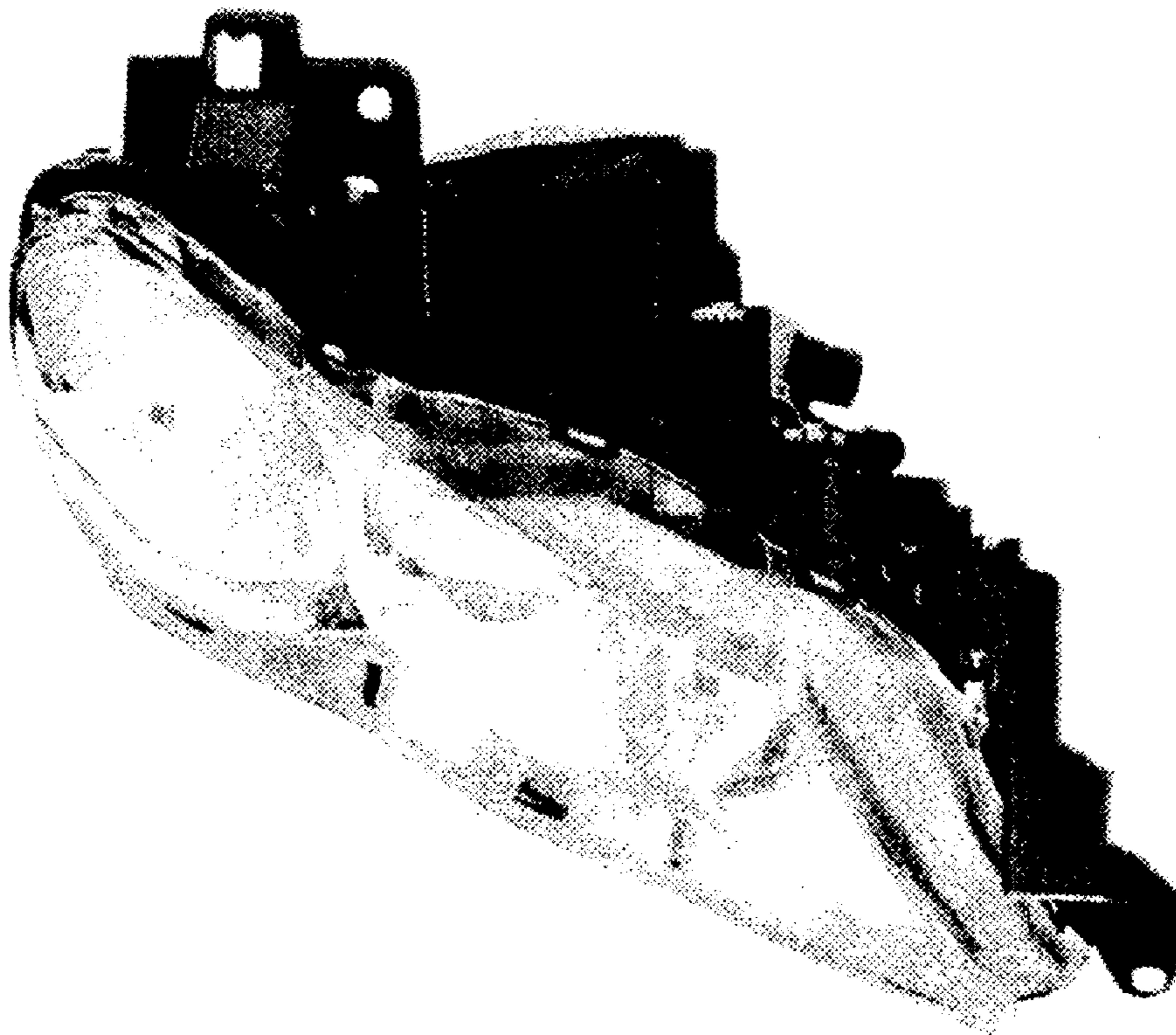

FIG. 4

UNITED STATES PATENT AND TRADEMARK OFFICE
CERTIFICATE OF CORRECTION

PATENT NO. : Des. 524,462 S
APPLICATION NO. : 29/216366
DATED : July 4, 2006
INVENTOR(S) : Takuya Ishibashi

Page 7 of 9

It is certified that error appears in the above-identified patent and that said Letters Patent is hereby corrected as shown below:

On Drawing Sheet 2 of 3 of the patent, replace Fig. 5 with the following:

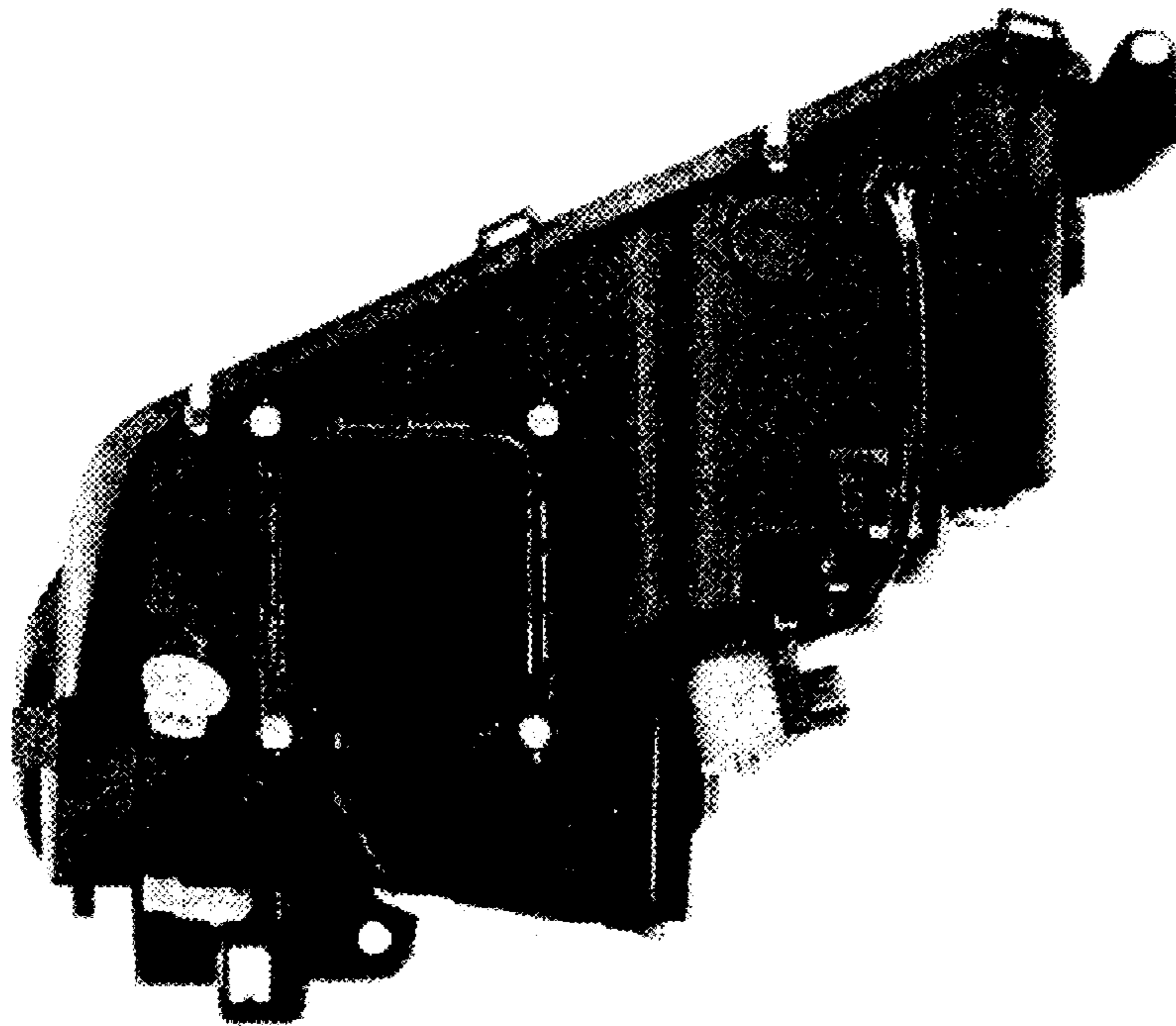

FIG. 5

UNITED STATES PATENT AND TRADEMARK OFFICE
CERTIFICATE OF CORRECTION

PATENT NO. : Des. 524,462 S
APPLICATION NO. : 29/216366
DATED : July 4, 2006
INVENTOR(S) : Takuya Ishibashi

Page 8 of 9

It is certified that error appears in the above-identified patent and that said Letters Patent is hereby corrected as shown below:

On Drawing Sheet 3 of 3 of the patent, replace Fig. 6 with the following:

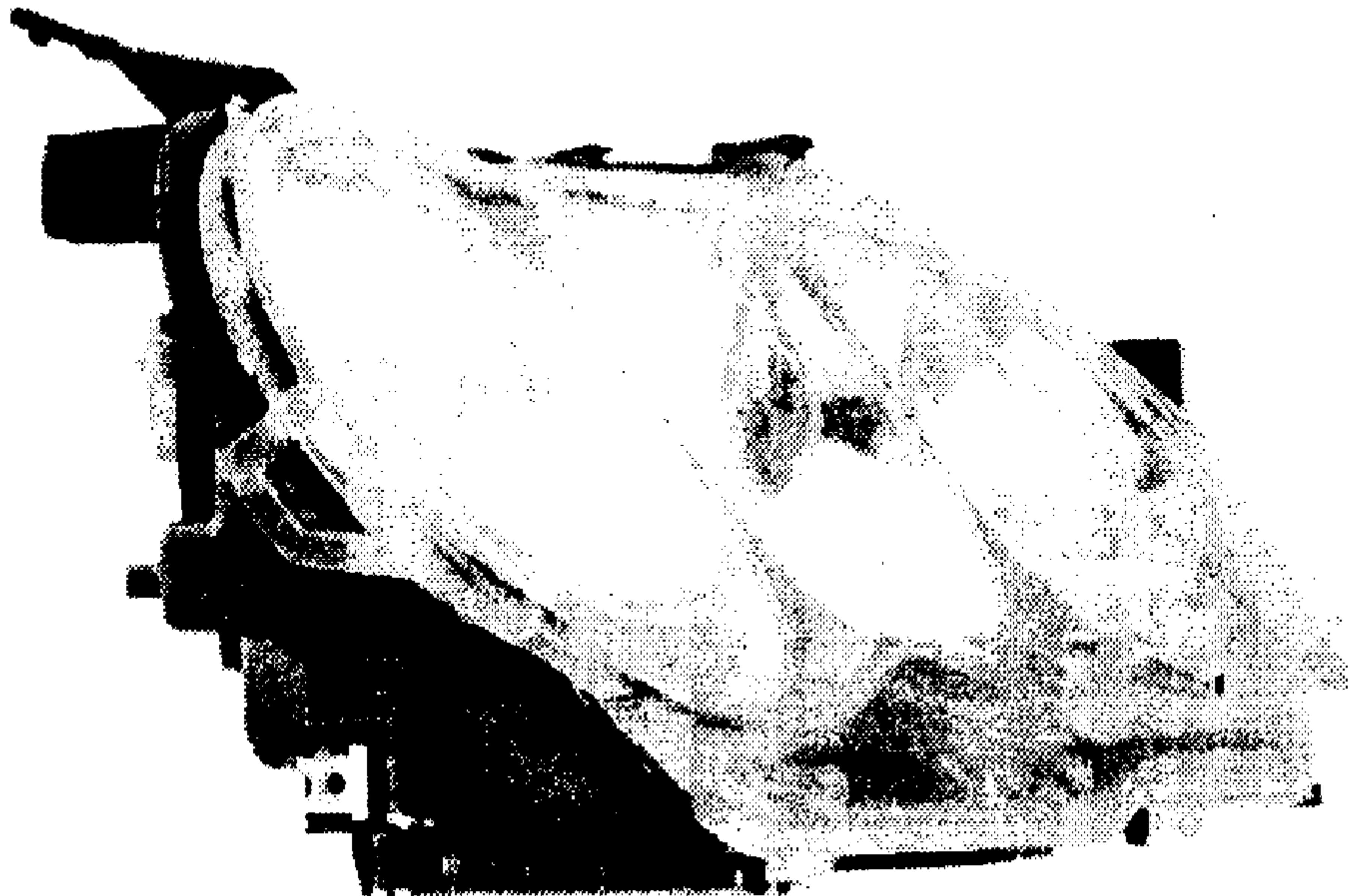

FIG. 6

UNITED STATES PATENT AND TRADEMARK OFFICE
CERTIFICATE OF CORRECTION

PATENT NO. : Des. 524,462 S
APPLICATION NO. : 29/216366
DATED : July 4, 2006
INVENTOR(S) : Takuya Ishibashi

Page 9 of 9

It is certified that error appears in the above-identified patent and that said Letters Patent is hereby corrected as shown below:

On Drawing Sheet 3 of 3 of the patent, replace Fig. 7 with the following:

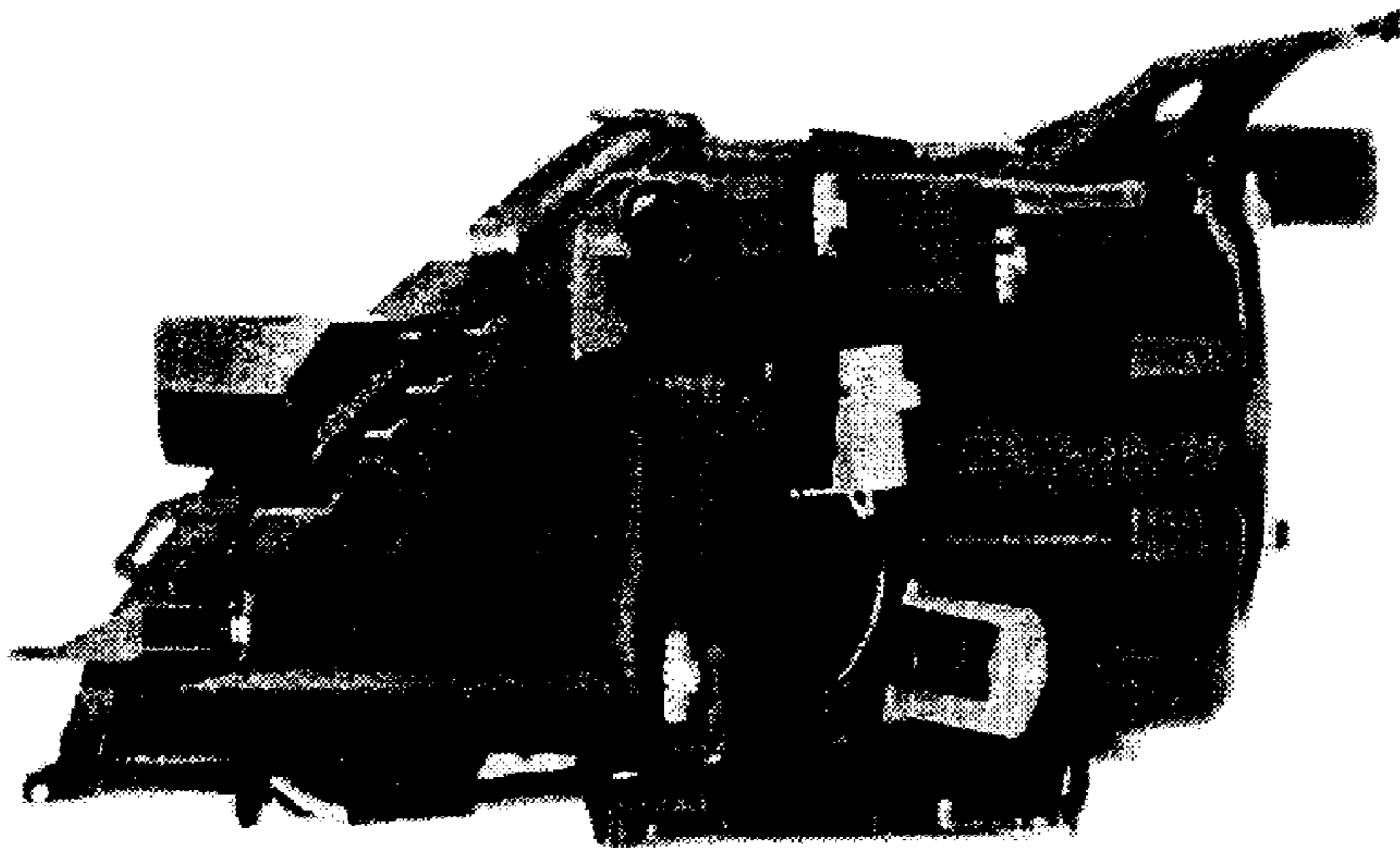

Fig. 7