

US00D524458S

(12) **United States Design Patent**  
**Chan**

(10) **Patent No.:** **US D524,458 S**

(45) **Date of Patent:** **\*\* Jul. 4, 2006**

(54) **LED NIGHT LIGHT**

(75) **Inventor:** **Wynsie Marie Chan**, Pasadena, CA (US)

(73) **Assignee:** **Doncorp USA, Inc.**, Monterey Park, CA (US)

(\*\*) **Term:** **14 Years**

(21) **Appl. No.:** **29/201,109**

(22) **Filed:** **Mar. 11, 2004**

(51) **LOC (8) Cl.** ..... **26-05**

(52) **U.S. Cl.** ..... **D26/26**

(58) **Field of Classification Search** ..... D26/26,  
D26/73, 94, 125, 127; 362/95, 653, 640-644,  
362/147, 404, 800, 806

See application file for complete search history.

(56) **References Cited**

**U.S. PATENT DOCUMENTS**

- D347,288 S \* 5/1994 Ham ..... D26/26
- D385,024 S \* 10/1997 Roberts ..... D23/366
- D404,508 S \* 1/1999 Marischen ..... D26/26

- 6,190,017 B1 \* 2/2001 Lai ..... 362/95
- D452,336 S \* 12/2001 Liu et al. .... D26/26
- D455,507 S \* 4/2002 Liu et al. .... D26/26
- D465,859 S \* 11/2002 Lo ..... D26/26

**OTHER PUBLICATIONS**

Polder 534-00 White Night Light from Amazon.com. Found online Jan. 13, 2006.\*

\* cited by examiner

*Primary Examiner*—Clare E Heflin

(74) *Attorney, Agent, or Firm*—Philip T. Virga

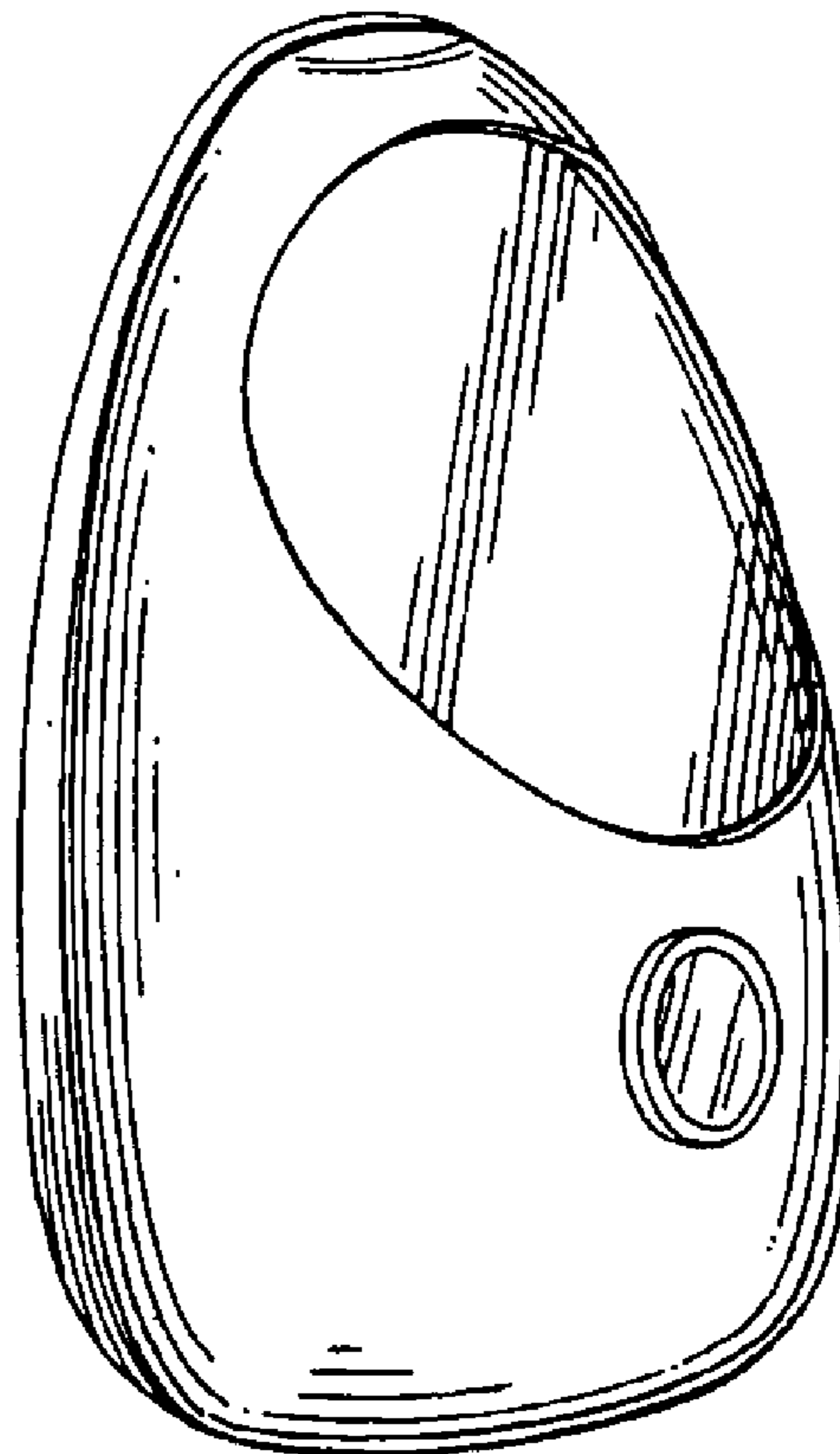
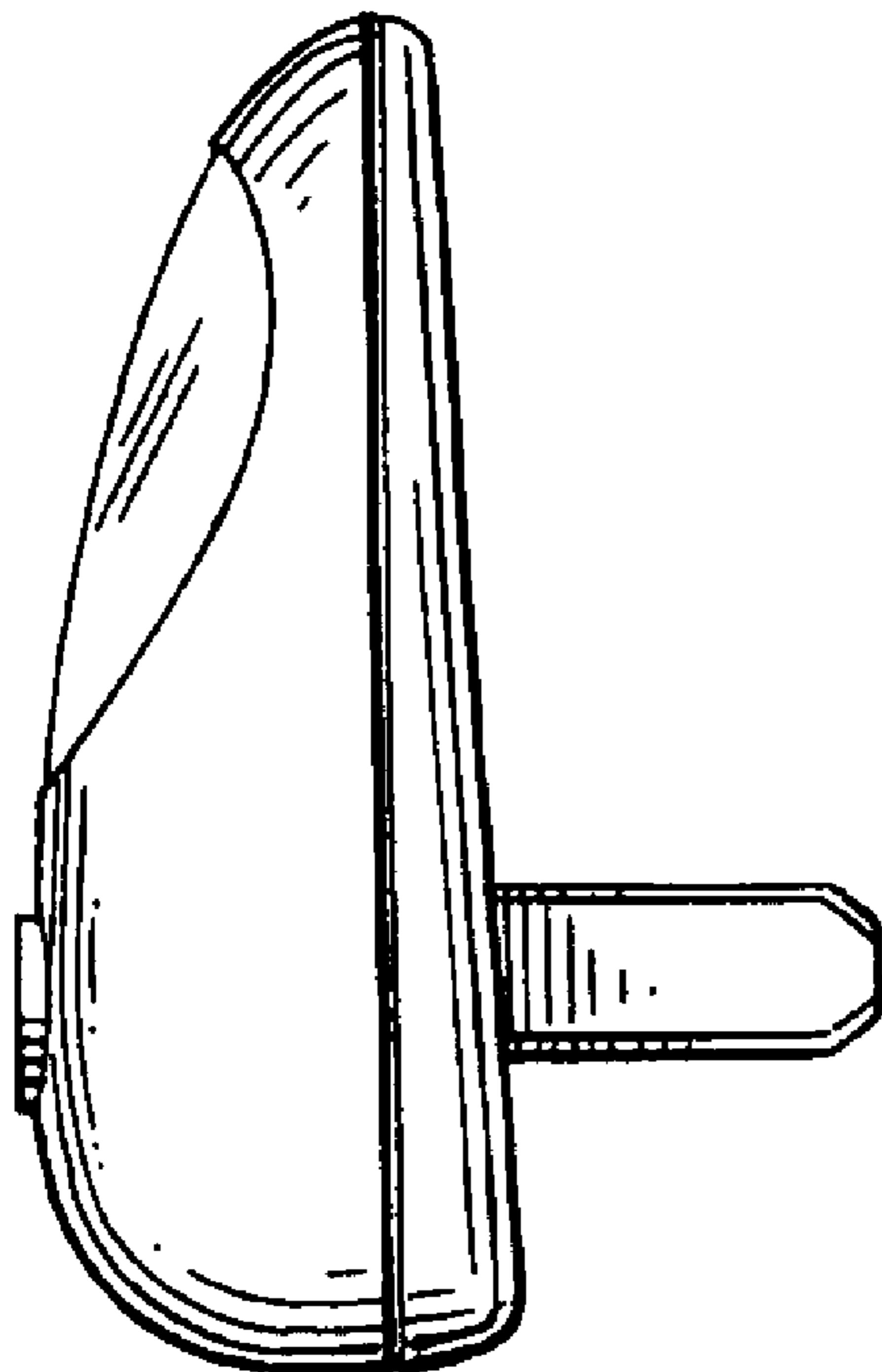
(57) **CLAIM**

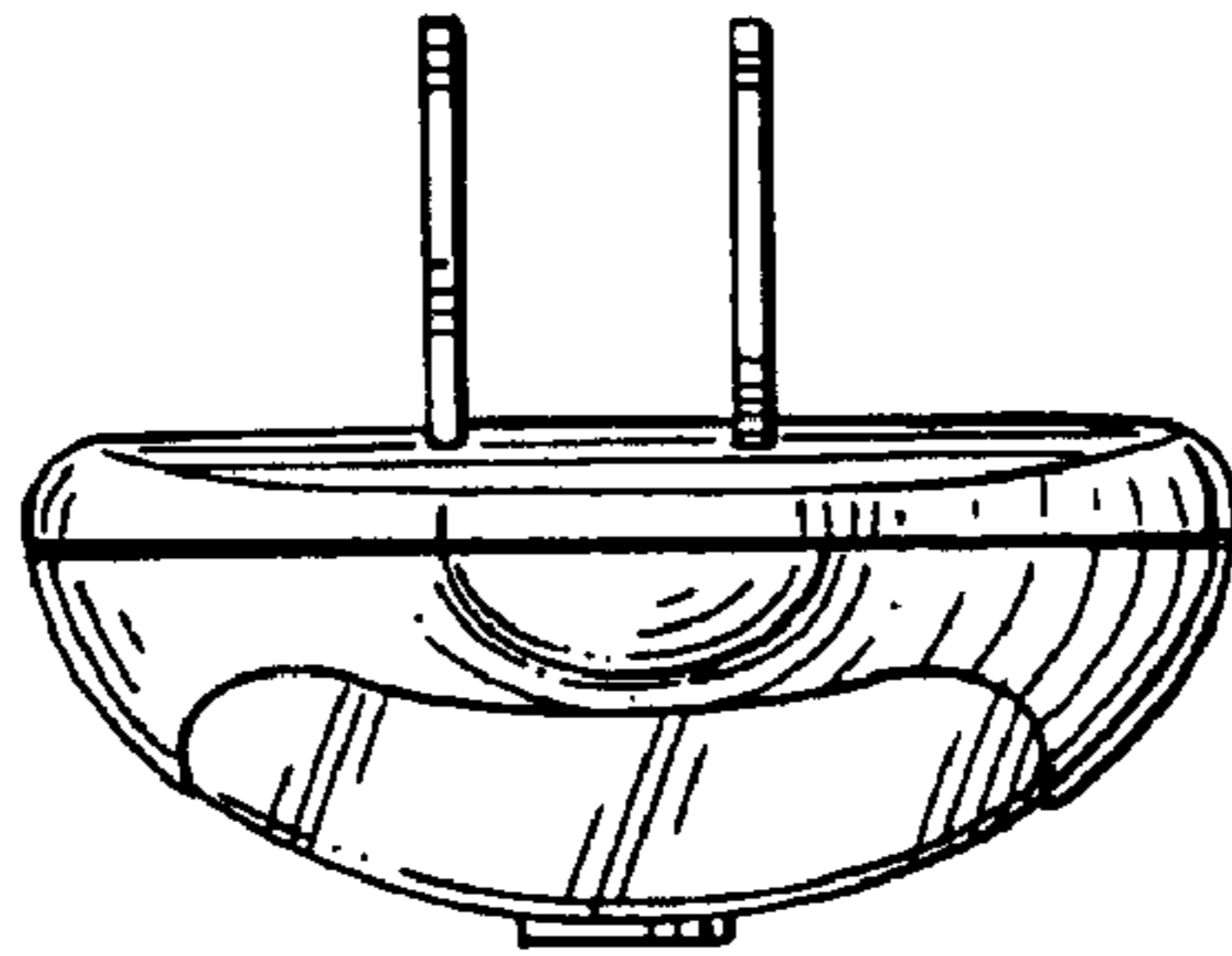
The ornamental design for an LED night light, substantially as shown and described.

**DESCRIPTION**

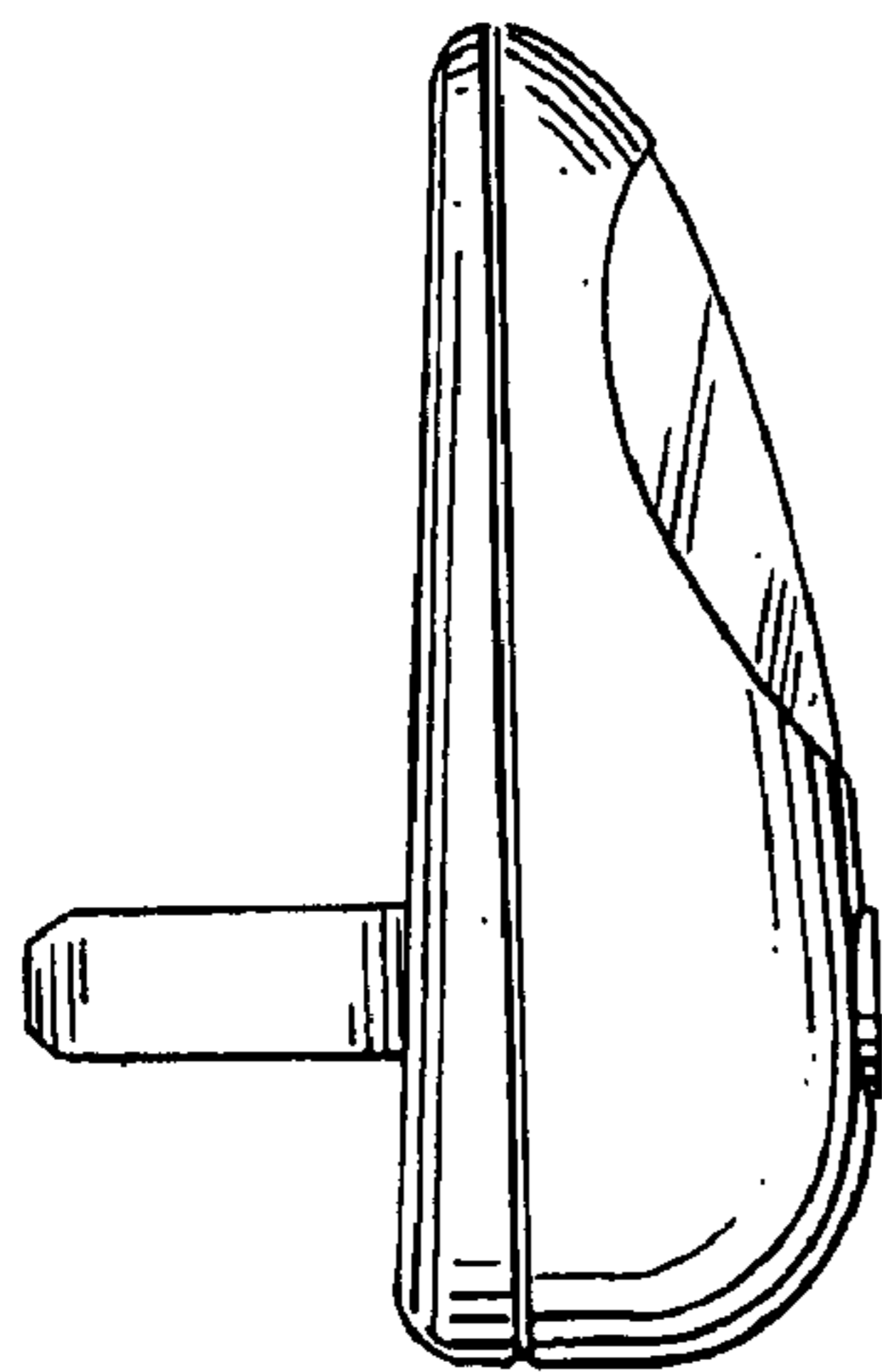
FIG. 1 is a top plan view of an LED night light; FIG. 2 is a front elevational view of FIG. 1; FIGS. 3 and 4 are side elevational views thereof; FIG. 5 is a bottom plan view of FIG. 1; FIG. 6 is a rear elevational view of FIG. 1; and, FIG. 7 is a perspective view of a LED night light.

**1 Claim, 2 Drawing Sheets**

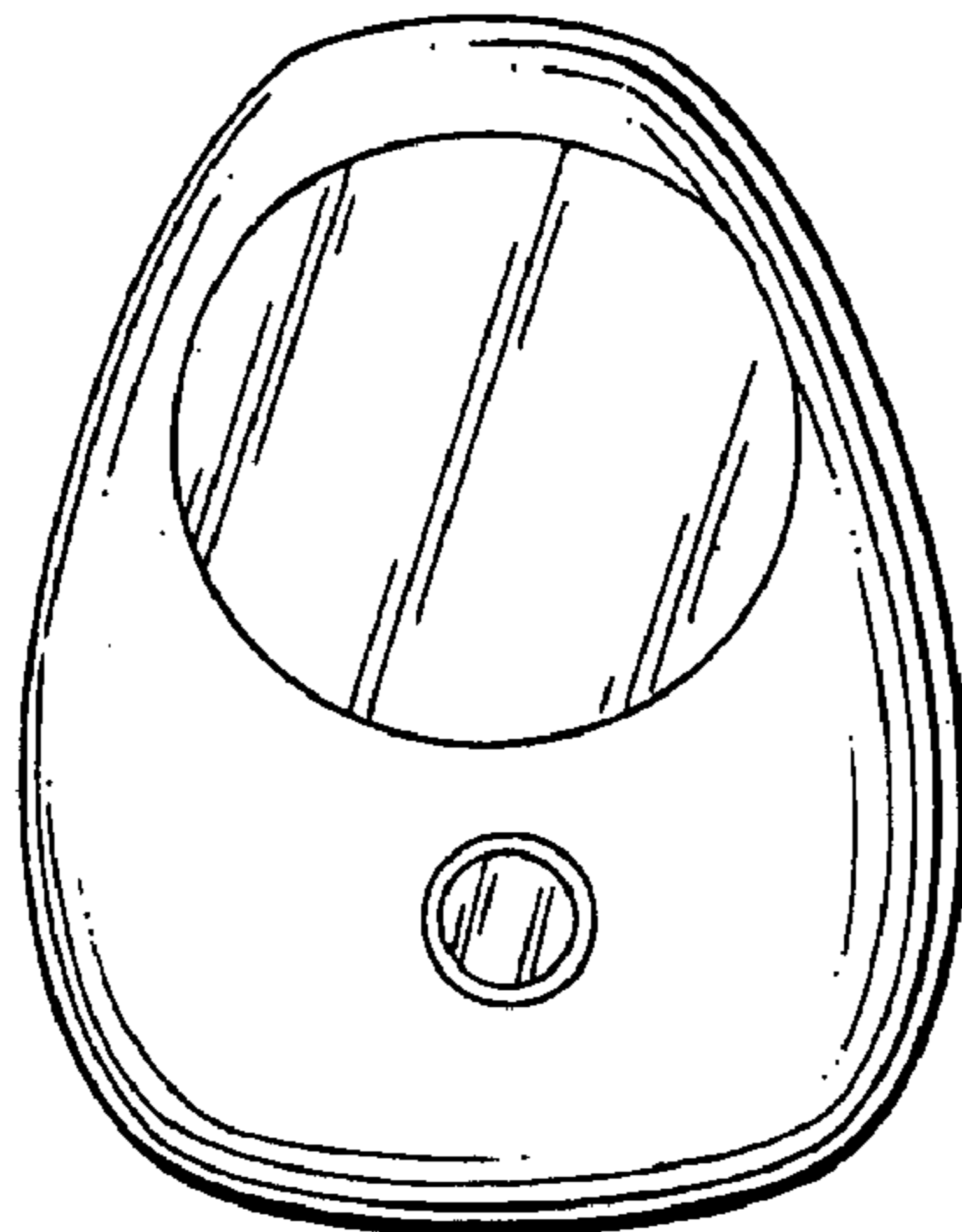




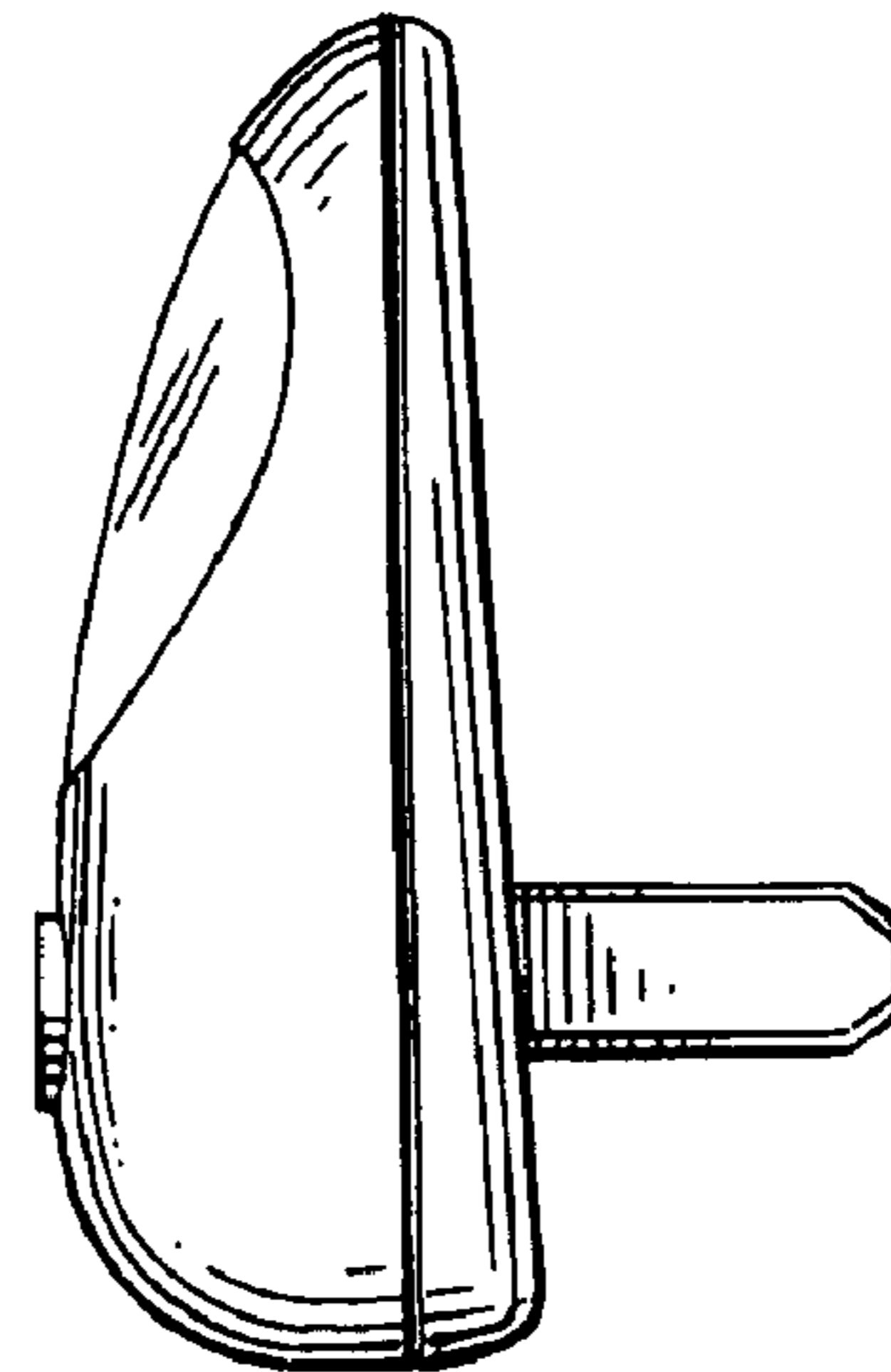
*FIG. 1*



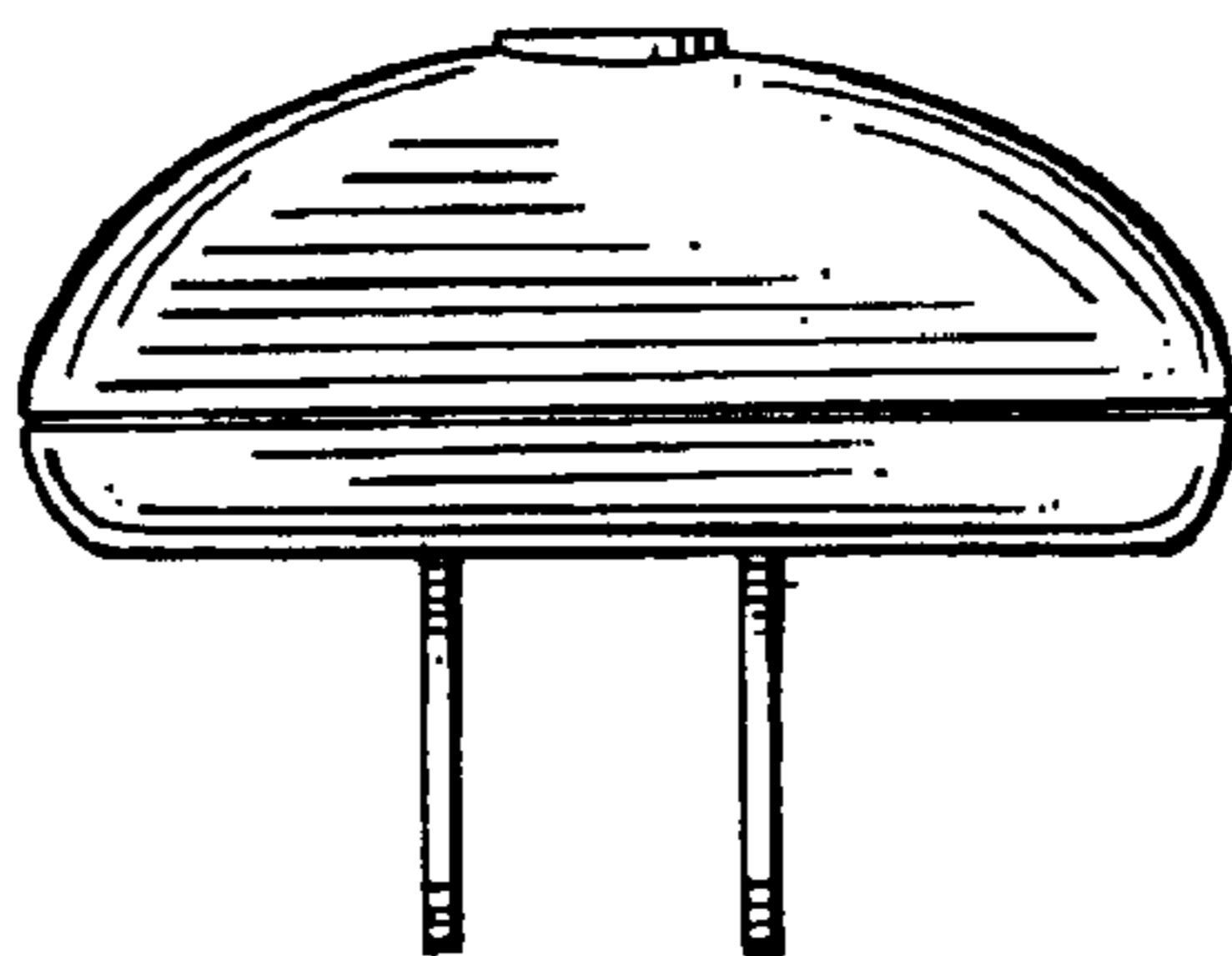
*FIG. 3*



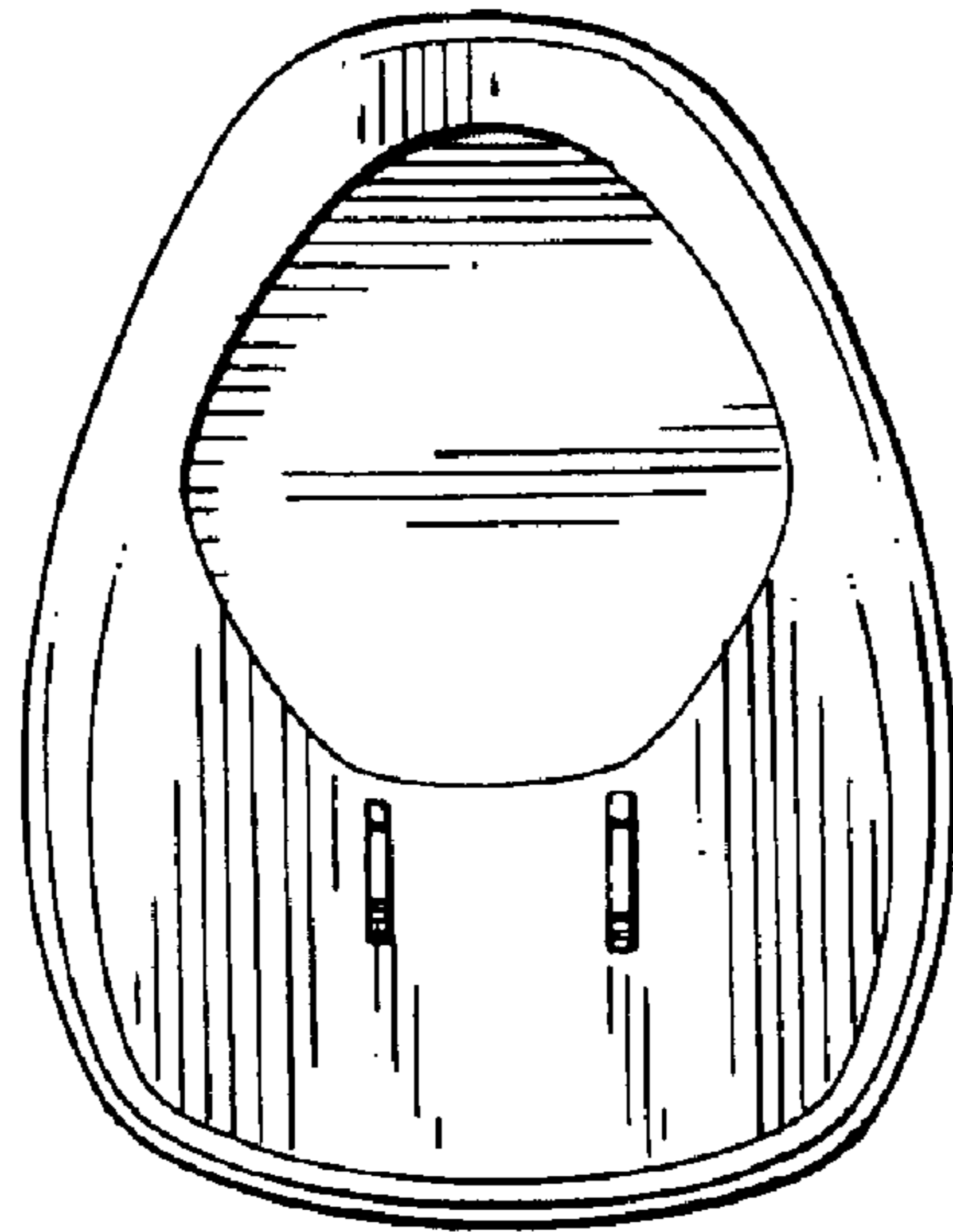
*FIG. 2*



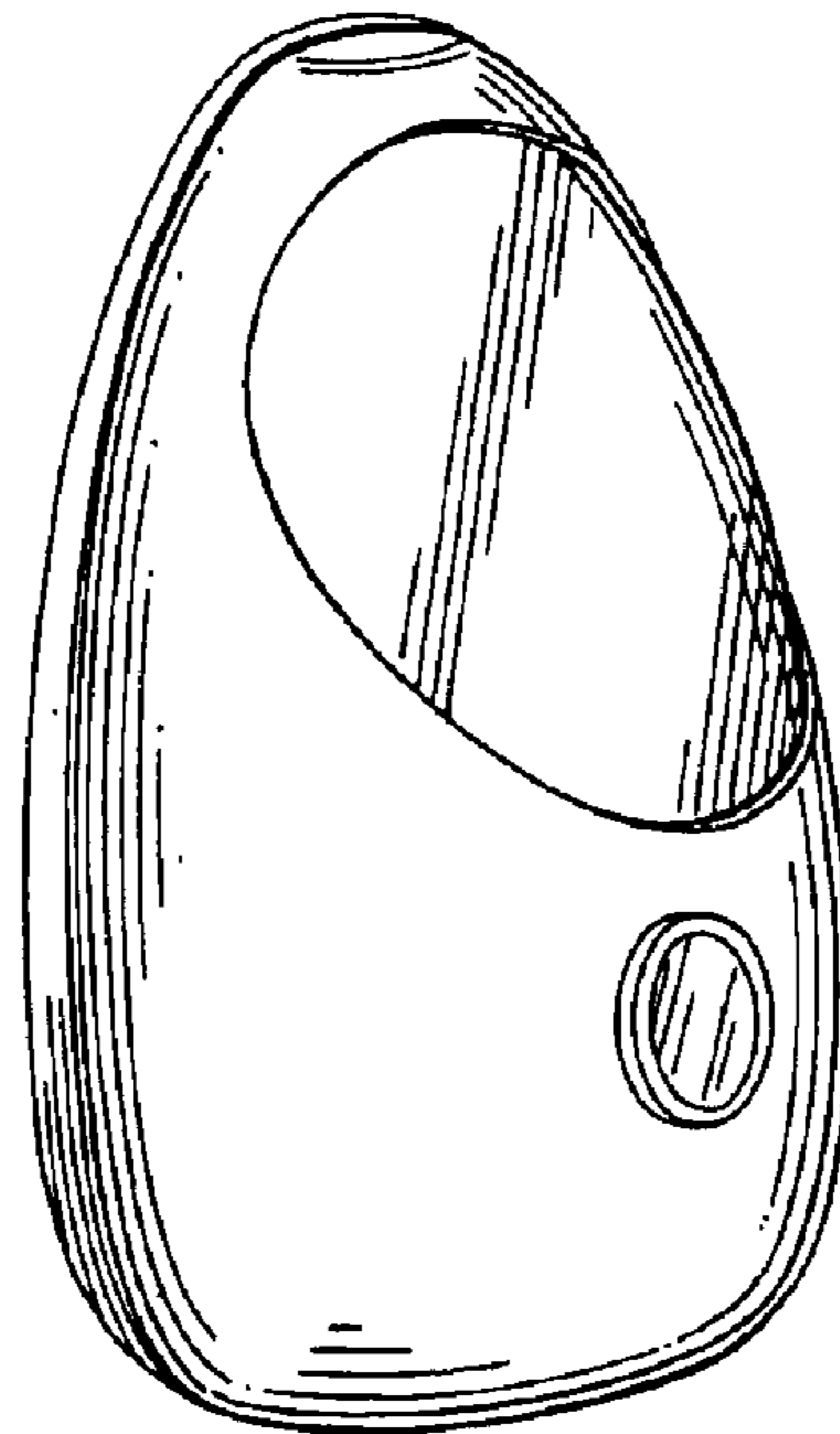
*FIG. 4*



*FIG. 5*



*FIG. 6*



*FIG. 7*