

US00D524430S

(12) **United States Design Patent**  
**Rodriguez**

(10) **Patent No.:** **US D524,430 S**

(45) **Date of Patent:** **\*\* Jul. 4, 2006**

(54) **TOILET**

D411,613 S \* 6/1999 Chiu ..... D23/301  
D416,314 S \* 11/1999 Chiu ..... D23/301

(76) Inventor: **Antuan Rodriguez**, 5441 SW. 5<sup>th</sup> Ter.,  
Miami, FL (US) 33134

\* cited by examiner

(\*\*) Term: **14 Years**

*Primary Examiner*—Robert A. Delehanty

(21) Appl. No.: **29/229,967**

(57) **CLAIM**

(22) Filed: **May 13, 2005**

The ornamental design for toilet, as shown and described.

(51) **LOC (8) Cl.** ..... **23-02**

**DESCRIPTION**

(52) **U.S. Cl.** ..... **D23/298**

FIG. 1 is a perspective view of a toilet showing my new design;

(58) **Field of Classification Search** ..... 4/663-664,  
4/300, 329, 420, 443, 661, DIG. 15; D23/270,  
D23/273-274, 295, 299, 301, 303, 309, 313;  
D6/358-359

FIG. 2 is a left side elevation view thereof;

FIG. 3 is a left perspective view thereof;

FIG. 4 is a rear perspective view thereof;

FIG. 5 is a top plan view thereof;

FIG. 6 is a rear elevation view thereof;

FIG. 7 is a right side elevation view thereof; and,

FIG. 8 is a front elevation view thereof.

See application file for complete search history.

The broken line showing of a floor line is for illustrative purposes only and forms no part of the claimed design.

(56) **References Cited**

**U.S. PATENT DOCUMENTS**

D4,269 S \* 8/1870 Cameron ..... D6/359  
4,221,431 A \* 9/1980 Rose ..... D6/358

**1 Claim, 3 Drawing Sheets**



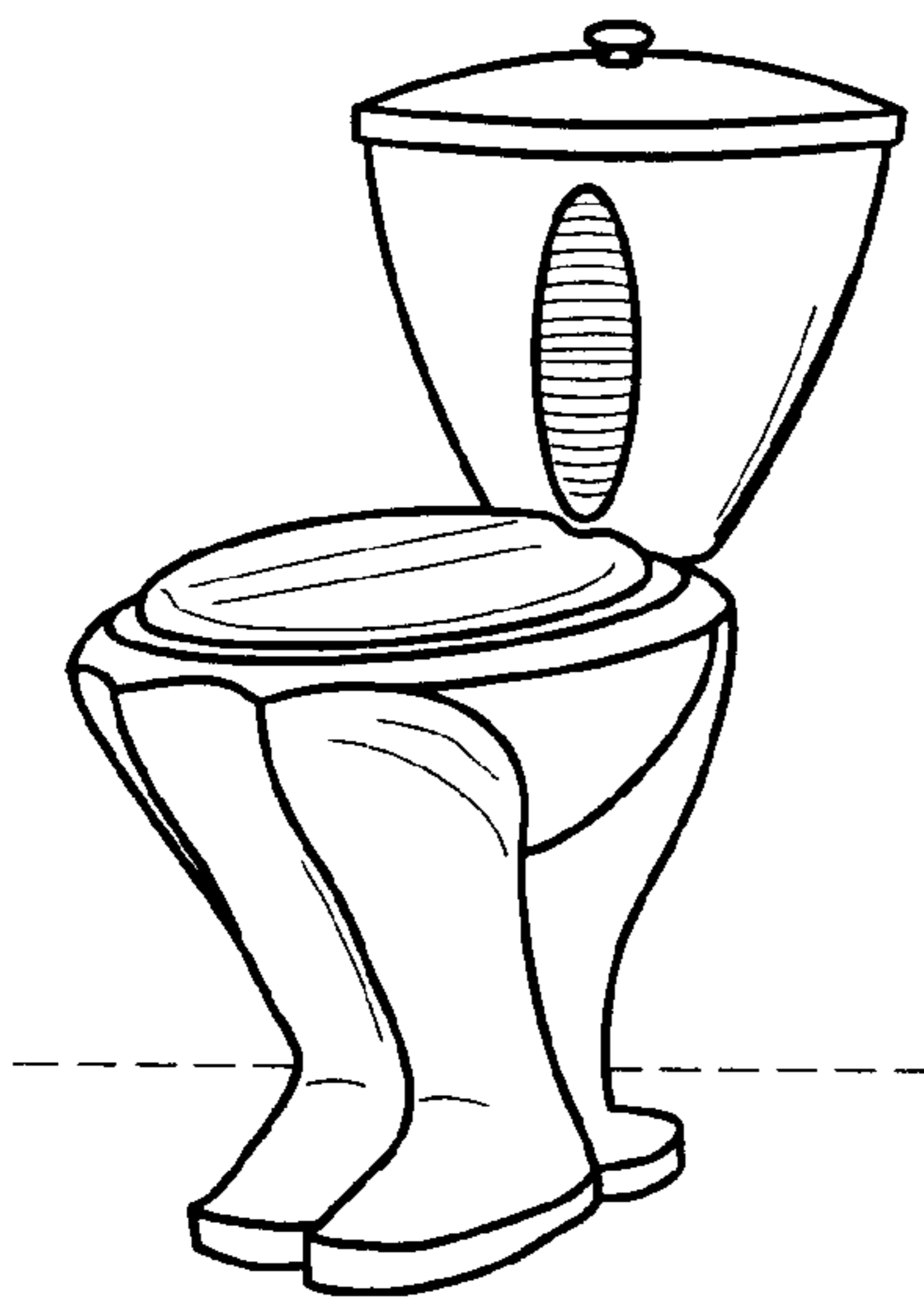

FIG. 1

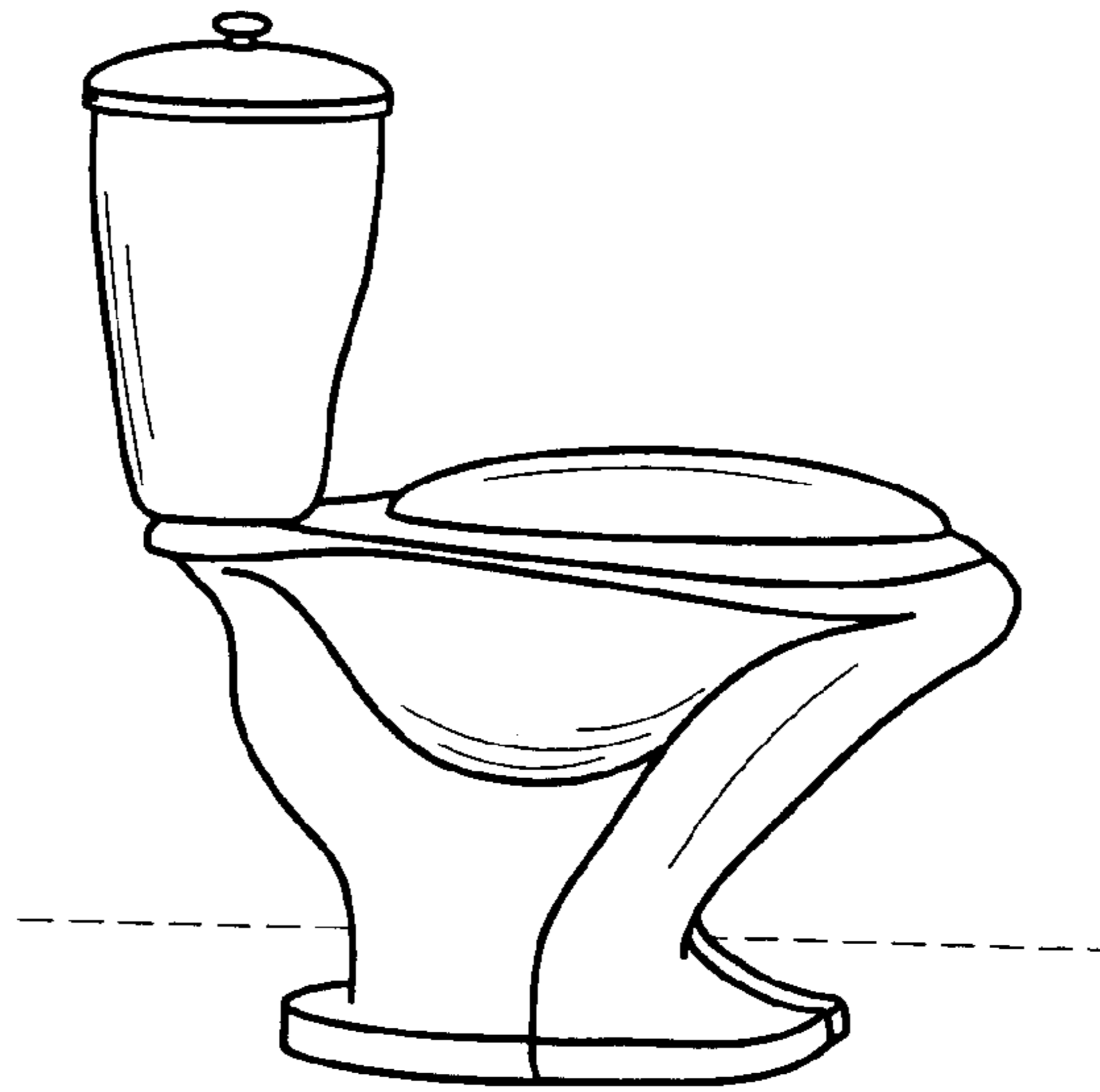

FIG. 2



FIG. 3

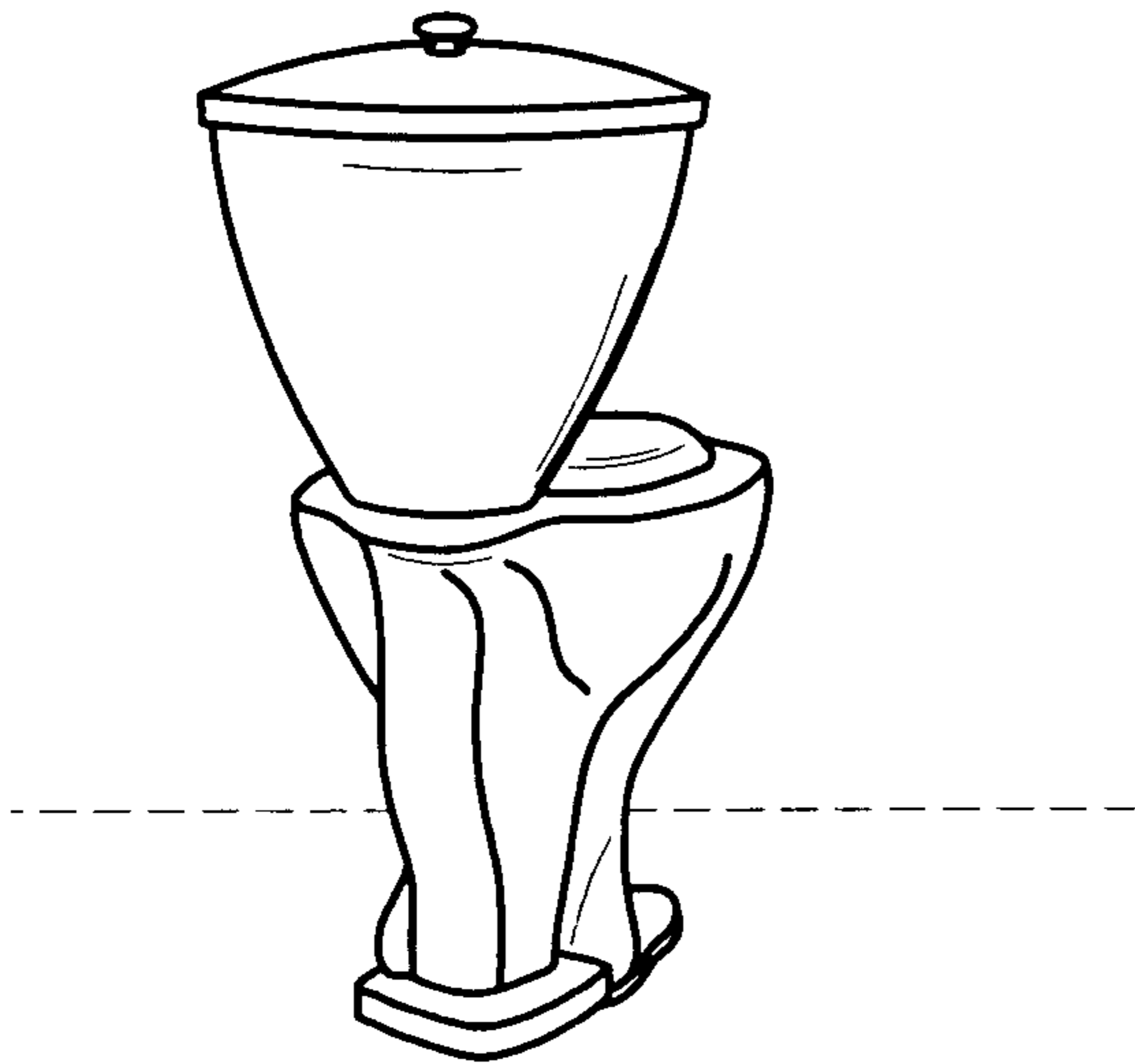

FIG. 4

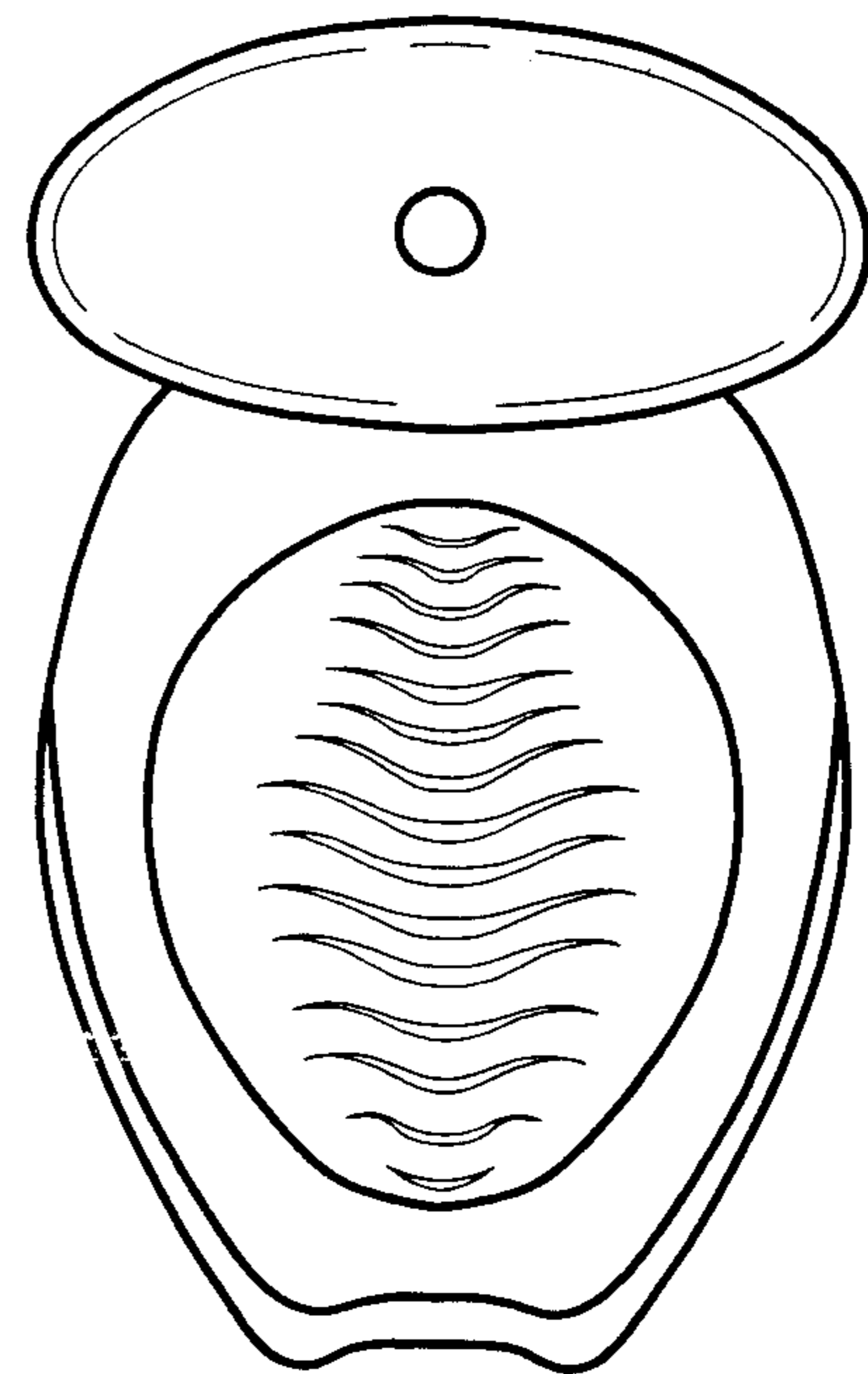

FIG. 5

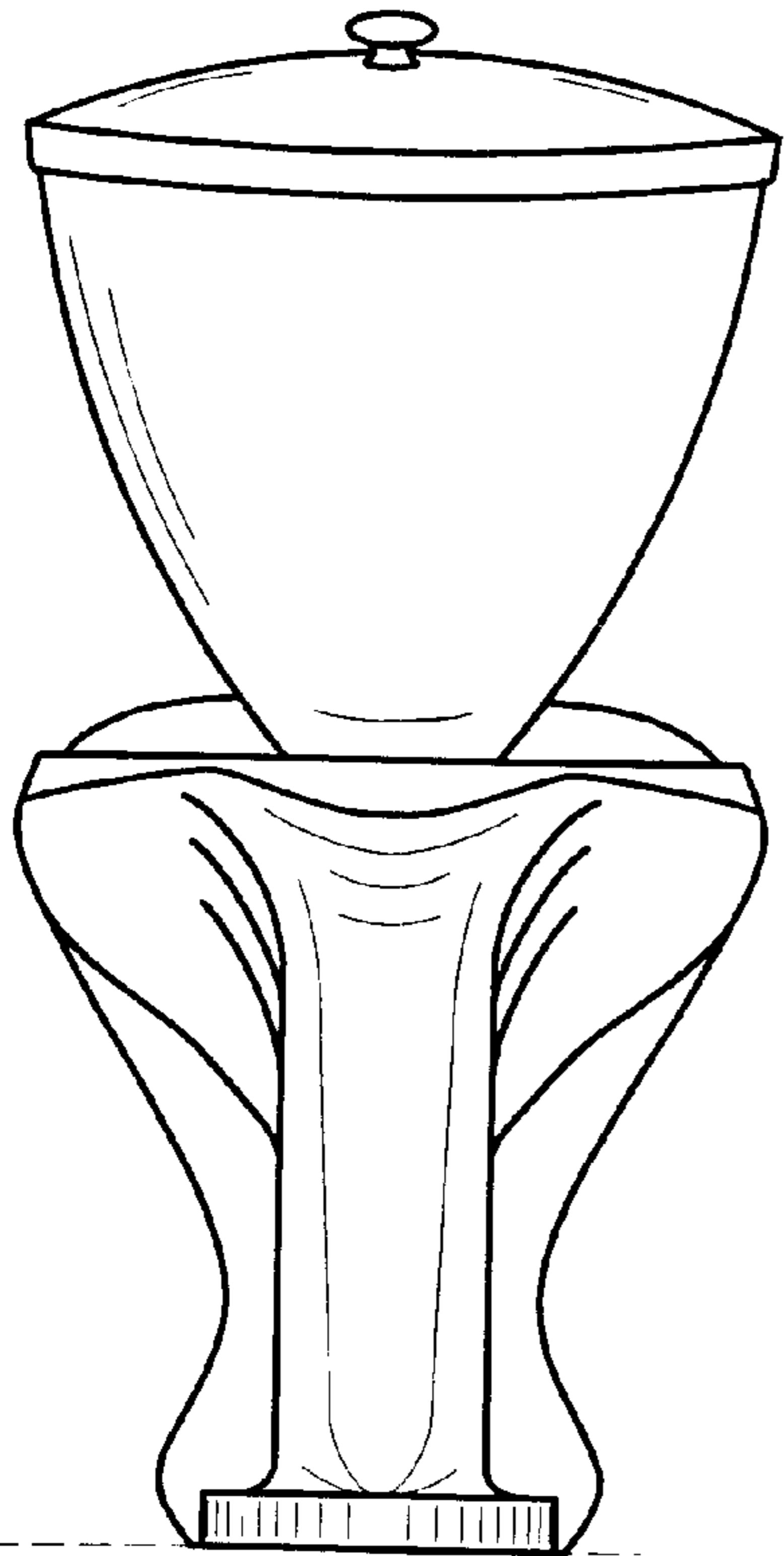

FIG. 6

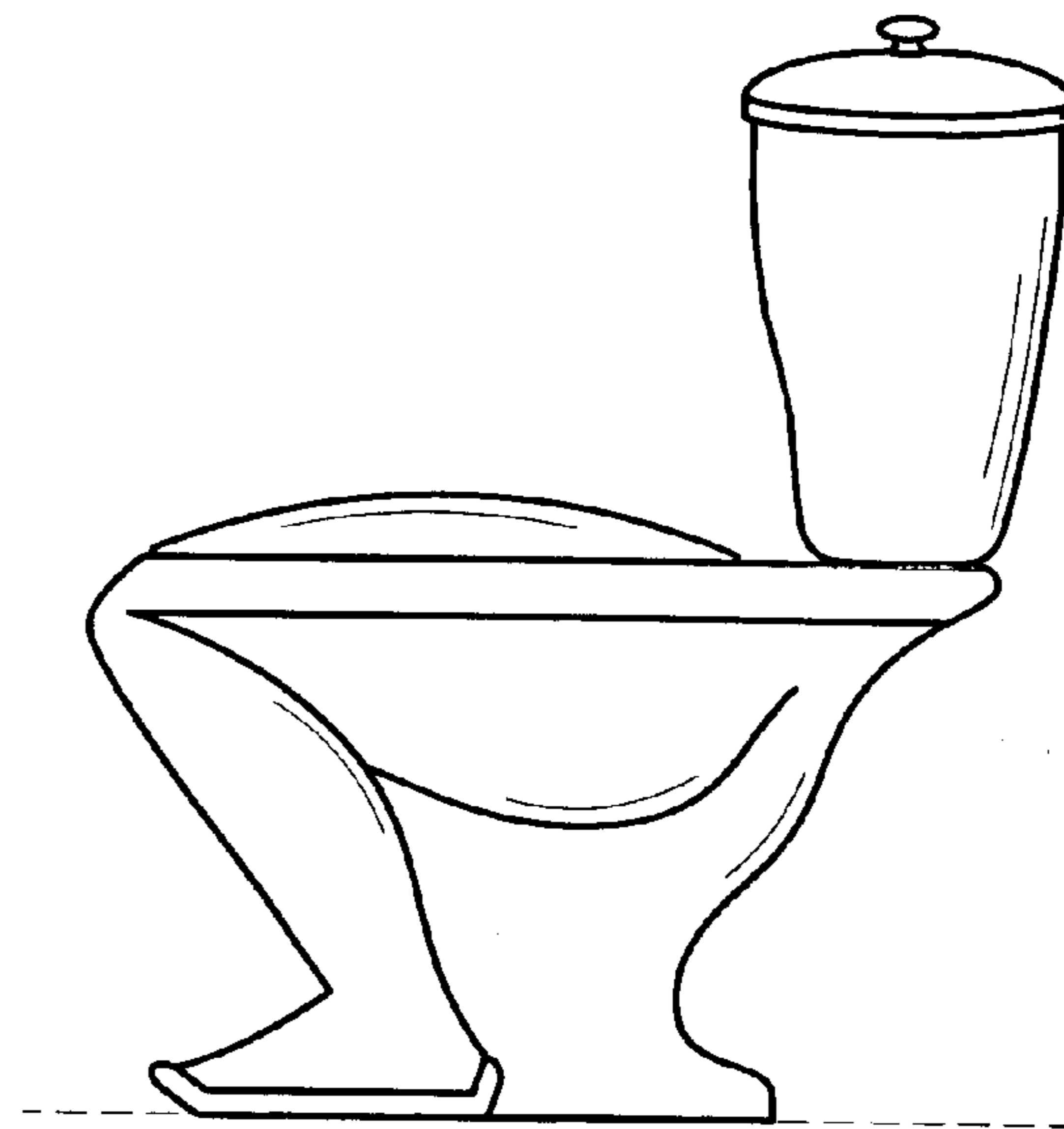

FIG. 7

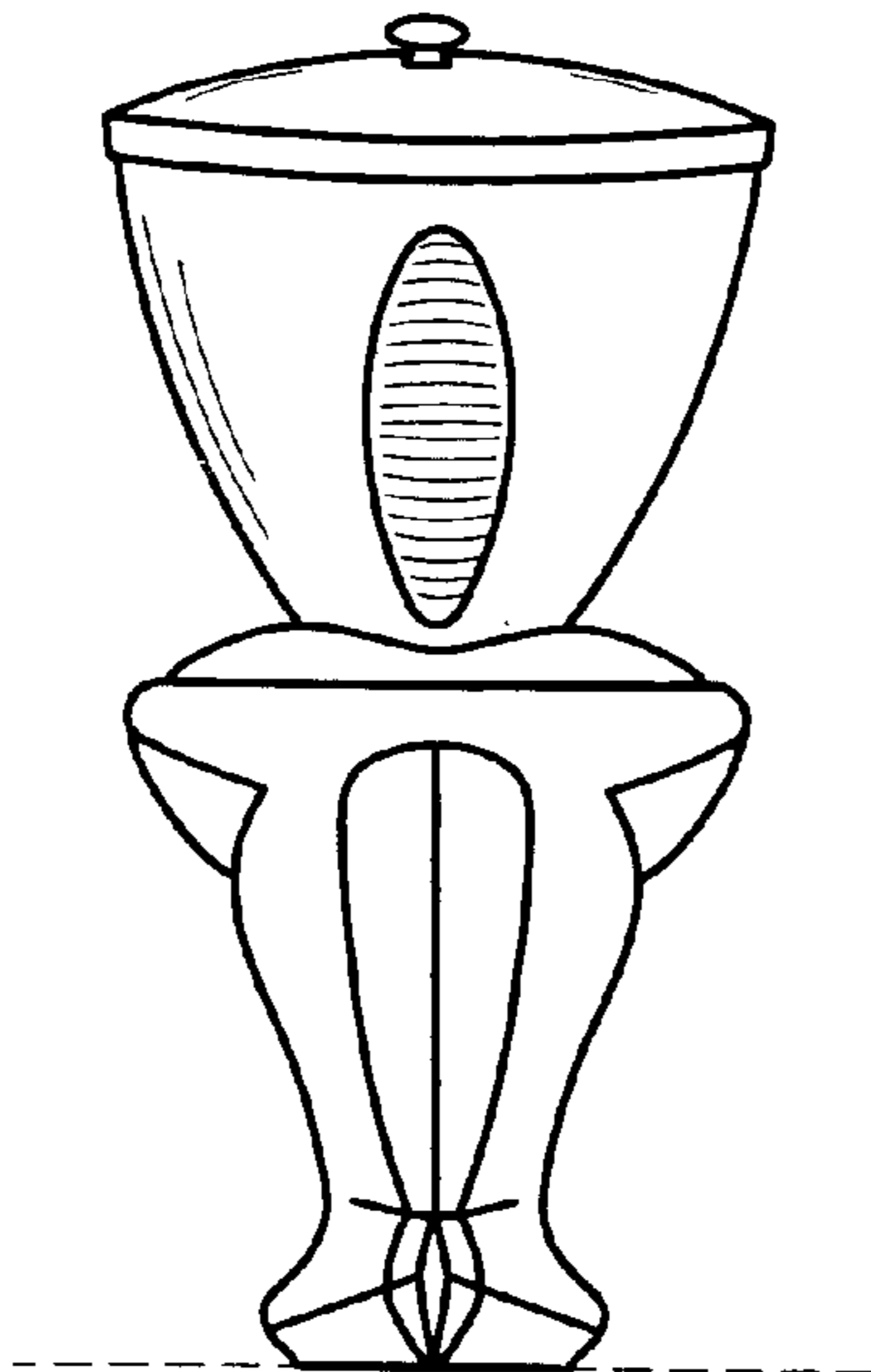

FIG. 8