

US00D524424S

(12) **United States Design Patent**  
**Schaffeld et al.**

(10) **Patent No.:** **US D524,424 S**

(45) **Date of Patent:** **\*\* Jul. 4, 2006**

(54) **FAUCET SPOUT**

D368,958 S \* 4/1996 Hill et al. .... D23/255  
D492,014 S \* 6/2004 Lin ..... D23/255

(75) Inventors: **John Schaffeld**, Marshfield, MA (US);  
**Steffen Koury**, Charlestown, MA (US);  
**Jacob A. Marks**, Allston, MA (US)

\* cited by examiner

(73) Assignee: **Masco Corporation of Indiana**,  
Indianapolis, IN (US)

*Primary Examiner*—Louis S. Zarfes  
*Assistant Examiner*—Gregory Andoll  
(74) *Attorney, Agent, or Firm*—Kwadjo Adusei-Poku;  
Lloyd D. Doigan

(\*\*) **Term:** **14 Years**

(57) **CLAIM**

(21) Appl. No.: **29/220,076**

The ornamental design for a faucet spout, as shown and described.

(22) Filed: **Dec. 23, 2004**

**DESCRIPTION**

(51) **LOC (8) Cl.** ..... **23-01**

(52) **U.S. Cl.** ..... **D23/255**

(58) **Field of Classification Search** ..... D23/238–257;  
4/675–678; 137/801

See application file for complete search history.

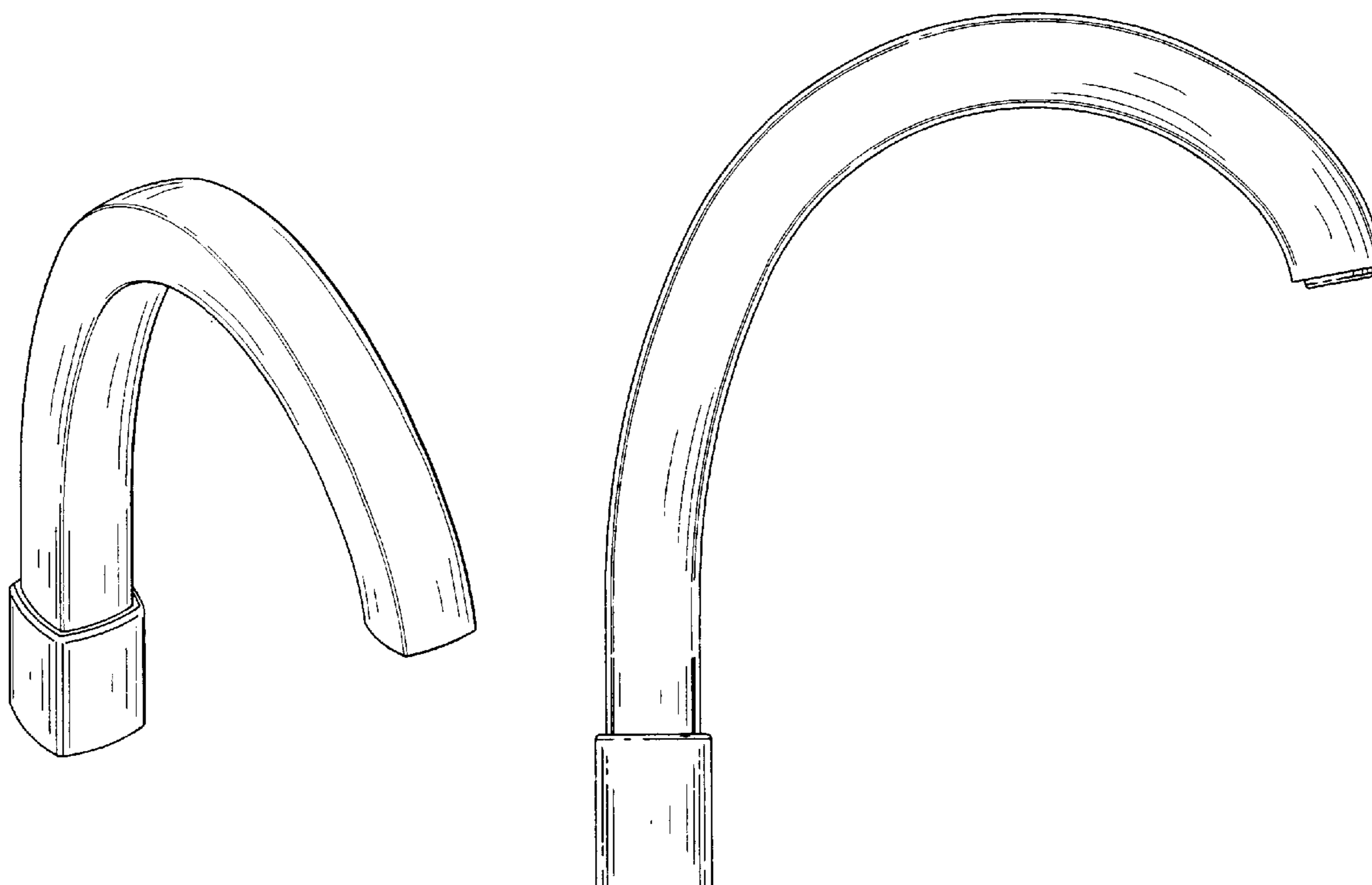
FIG. 1 is a front perspective view of a faucet spout showing my design;  
FIG. 2 is a front elevational view thereof;  
FIG. 3 is a rear elevational view thereof;  
FIG. 4 is a right side elevational view, the left side elevational view being a mirror image thereof;  
FIG. 5 is a top plan view thereof; and,  
FIG. 6 is a rear perspective view thereof.

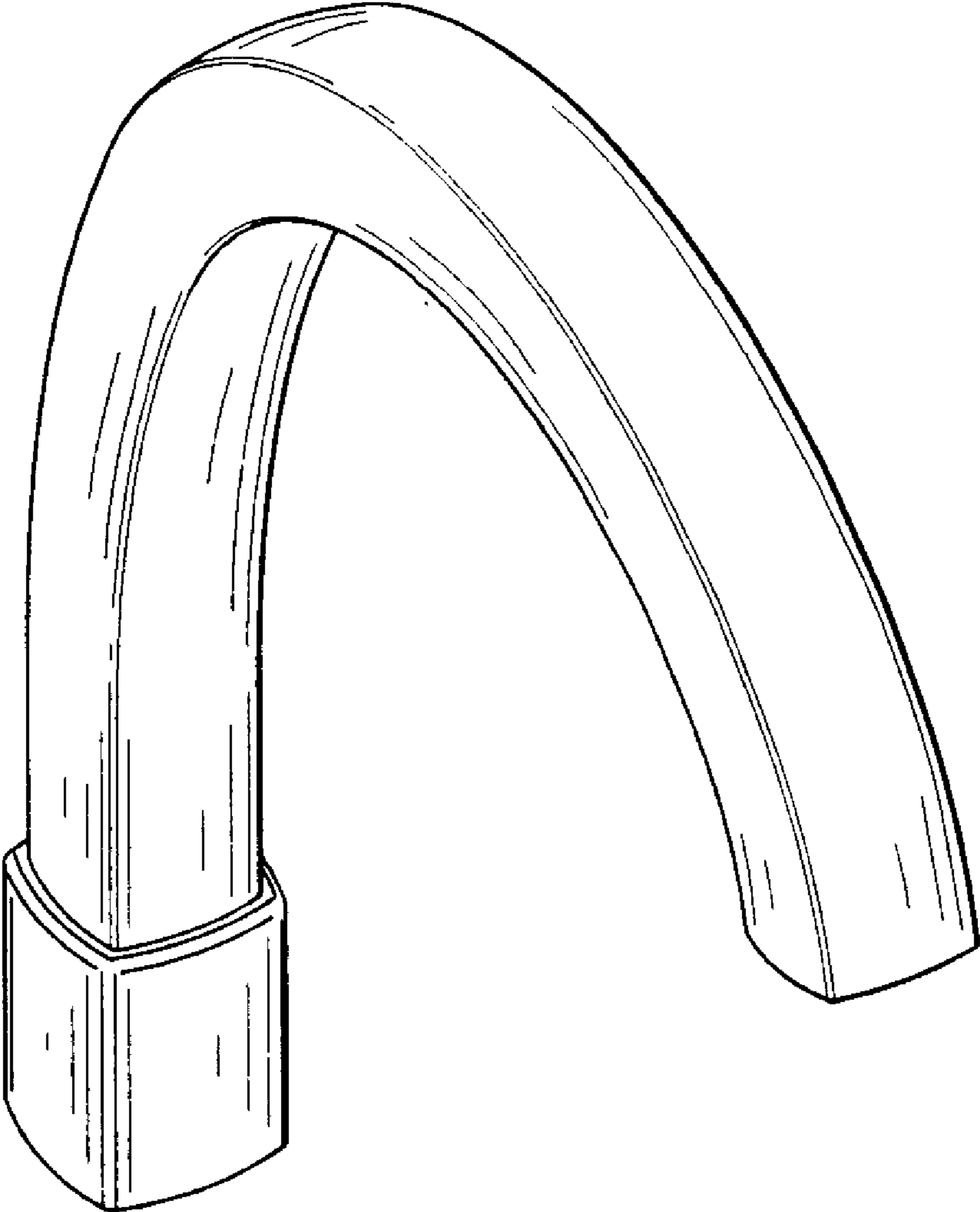
(56) **References Cited**

**U.S. PATENT DOCUMENTS**

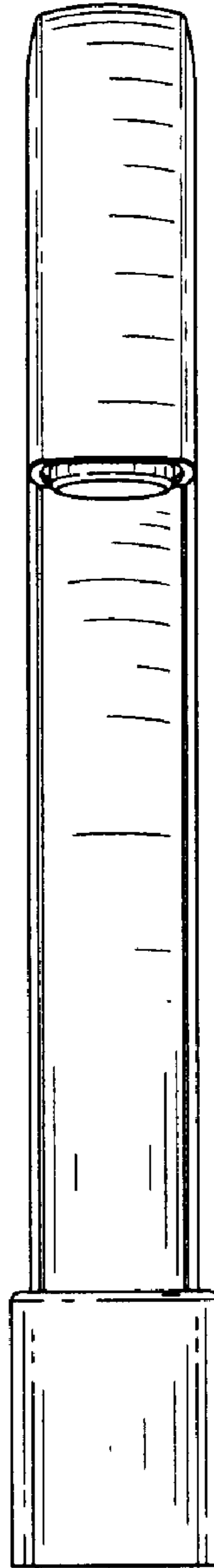
D364,219 S \* 11/1995 Hill et al. .... D23/255  
D367,920 S \* 3/1996 Hill et al. .... D23/255

**1 Claim, 6 Drawing Sheets**

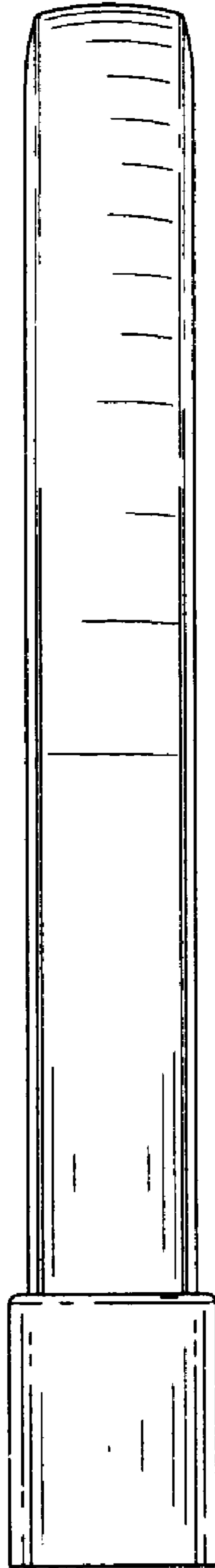




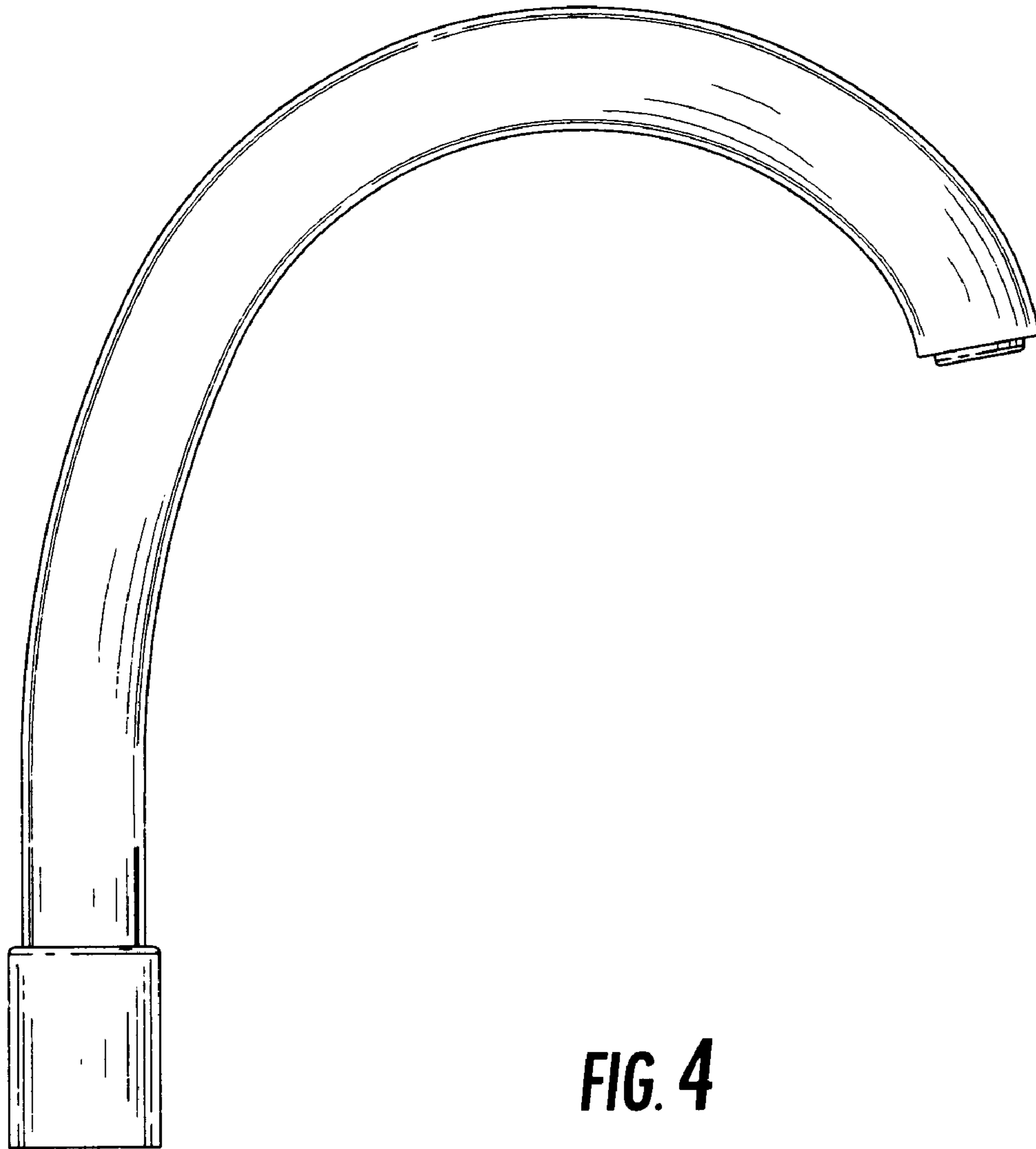
**FIG. 1**



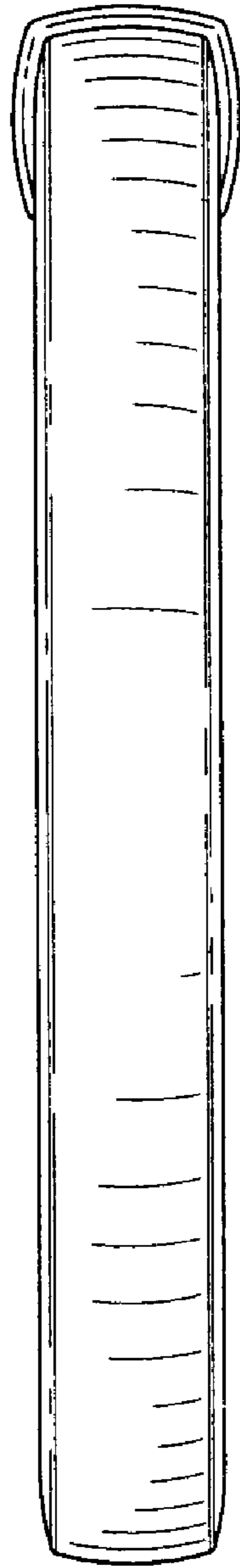
**FIG. 2**



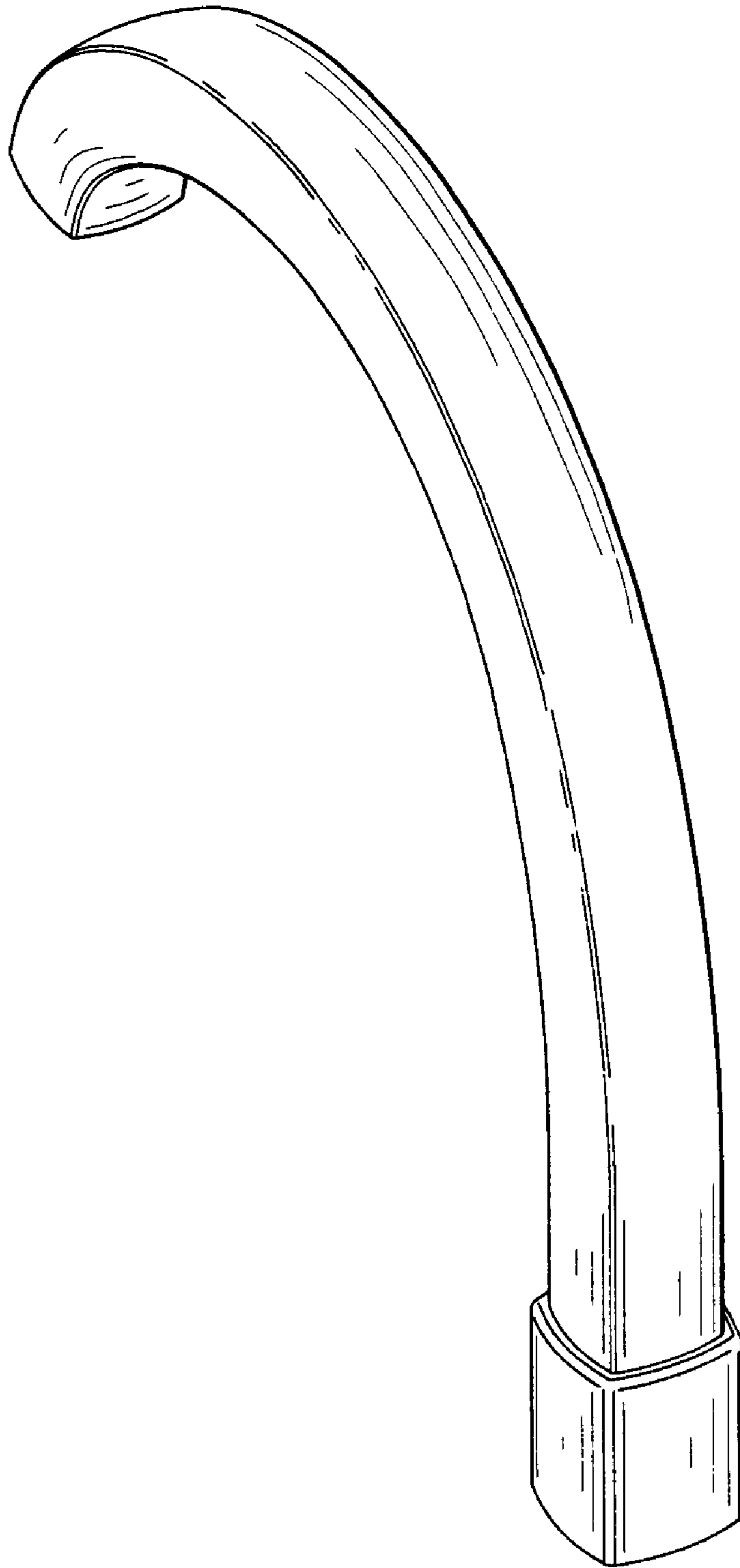
**FIG. 3**



**FIG. 4**



**FIG. 5**



**FIG. 6**