

US00D524388S

(12) **United States Design Patent**
Tang et al.

(10) **Patent No.:** **US D524,388 S**

(45) **Date of Patent:** **** Jul. 4, 2006**

- (54) **GOLF CLUB HEAD**
- (75) Inventors: **Larry G. Tang**, Carlsbad, CA (US);
Ronald K. Hettinger, Oceanside, CA (US)
- (73) Assignee: **Callaway Golf Company**, Carlsbad, CA (US)
- (**) Term: **14 Years**
- (21) Appl. No.: **29/235,515**
- (22) Filed: **Aug. 2, 2005**
- (51) **LOC (8) Cl.** **21-02**
- (52) **U.S. Cl.** **D21/752**
- (58) **Field of Classification Search** D21/733,
D21/752; 473/324–331, 343–346
See application file for complete search history.

4,872,685 A	10/1989	Sun	
4,877,249 A	10/1989	Thompson	
4,930,783 A	6/1990	Antonious	
5,106,094 A	4/1992	Desboilles et al.	
5,193,811 A	3/1993	Okumoto et al.	
5,242,168 A	9/1993	Aizawa	
D340,492 S	10/1993	Flood	
5,282,624 A	2/1994	Viste	
5,310,185 A	5/1994	Viollaz et al.	
5,344,140 A	9/1994	Anderson	
5,377,986 A	1/1995	Viollaz et al.	
D356,843 S	3/1995	Schmidt et al.	
5,398,935 A	3/1995	Katayama	
5,410,798 A	5/1995	Lo	
5,425,538 A	6/1995	Vincent et al.	
5,499,814 A	3/1996	Lu	
5,516,107 A	5/1996	Okumoto et al.	
D372,063 S	* 7/1996	Hueber D21/752
5,547,427 A	8/1996	Rigal et al.	
5,570,886 A	11/1996	Rigal et al.	
5,624,331 A	4/1997	Lo et al.	
5,743,813 A	4/1998	Chen et al.	
D394,687 S	5/1998	Mahaffey et al.	
5,762,567 A	6/1998	Antonious	
5,766,095 A	6/1998	Antonious	

(56) **References Cited**

U.S. PATENT DOCUMENTS

1,167,387 A	1/1916	Daniel	
1,638,916 A	8/1927	Butchart	
1,780,625 A	11/1930	Mattern	
2,336,405 A	12/1943	Kent	
2,750,194 A	6/1956	Clark	
D179,002 S	10/1956	Hoffmeister	
3,397,888 A	8/1968	Springer et al.	
3,486,775 A	12/1969	Hodge	
3,692,306 A	9/1972	Glover	
D226,431 S	3/1973	Baker	
3,897,066 A	7/1975	Belmont	
3,901,514 A	8/1975	Priaulux	
3,937,474 A	2/1976	Jepson et al.	
3,975,023 A	8/1976	Inamori	
3,981,507 A	9/1976	Nunziato	
3,989,248 A	11/1976	Campau	
4,021,047 A	5/1977	Mader	
D245,358 S	* 8/1977	Barber D21/752
D268,357 S	* 3/1983	Mader D21/733
4,398,965 A	8/1983	Campau	
4,568,088 A	2/1986	Kurahashi	
4,778,185 A	10/1988	Kurokawa	
4,828,265 A	5/1989	Antonious	

(Continued)

Primary Examiner—Mitchell Siegel
(74) *Attorney, Agent, or Firm*—Michael A. Catania; Elaine H. Lo

(57) **CLAIM**

The ornamental design for a golf club head, as shown and described.

DESCRIPTION

FIG. 1 is a front view thereof;
FIG. 2 is a top plan view thereof;
FIG. 3 is a bottom plan view thereof;
FIG. 4 is a rear perspective view thereof;
FIG. 5 is a heel view thereof; and,
FIG. 6 is a toe view thereof.
The broken line showing is for illustrative purposes only and forms no part of the claimed design.

1 Claim, 3 Drawing Sheets

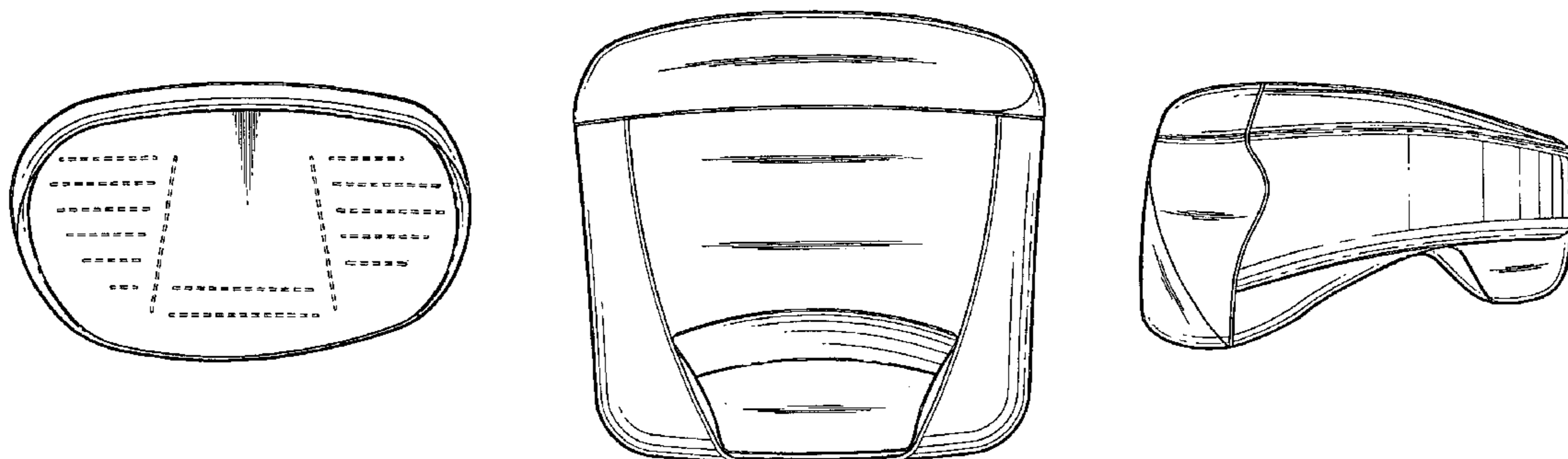

US D524,388 S

Page 2

U.S. PATENT DOCUMENTS

5,776,011 A	7/1998	Su et al.		D437,624 S	2/2001	Tate	
D400,625 S	11/1998	Kubica et al.		D440,616 S	4/2001	Helmstetter et al.	
D404,098 S	1/1999	Ishikawa et al.		D441,819 S	5/2001	Helmstetter et al.	
D404,778 S	1/1999	Strand		D443,668 S	6/2001	Nicolette et al.	
5,863,261 A	1/1999	Eggiman		D457,209 S	5/2002	Soracco et al.	
D415,807 S	* 10/1999	Werner et al.	D21/733	D476,388 S	6/2003	Burnett et al.	
5,989,134 A	11/1999	Antonious		6,672,975 B1	1/2004	Galloway	
D423,067 S	4/2000	Sanchez et al.		D487,786 S	3/2004	Tang	
6,071,200 A	6/2000	Song		D489,105 S	* 4/2004	Kim	D21/733
6,074,310 A	6/2000	Ota		6,739,982 B1	5/2004	Murphy et al.	
D428,950 S	8/2000	Galloway et al.		6,860,818 B1	3/2005	Mahaffey et al.	
D430,244 S	8/2000	Besnard		D503,761 S	4/2005	Tuerschmann et al.	
6,146,571 A	11/2000	Vincent et al.		6,875,129 B1	4/2005	Erickson et al.	
6,149,534 A	11/2000	Peters et al.		D506,236 S	* 6/2005	Evans et al.	D21/752
D437,375 S	2/2001	Hocknell et al.					

* cited by examiner

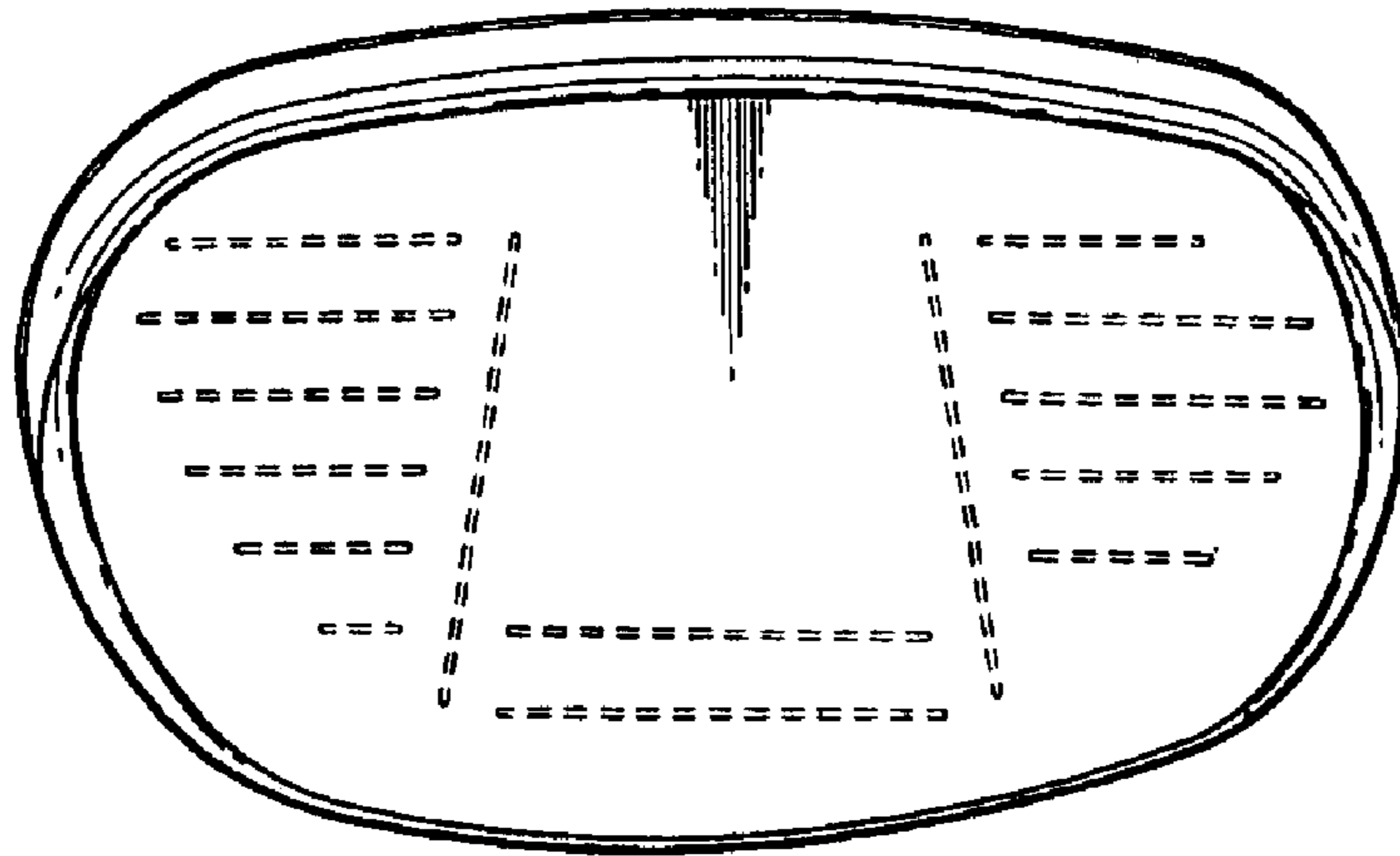

FIG. 1

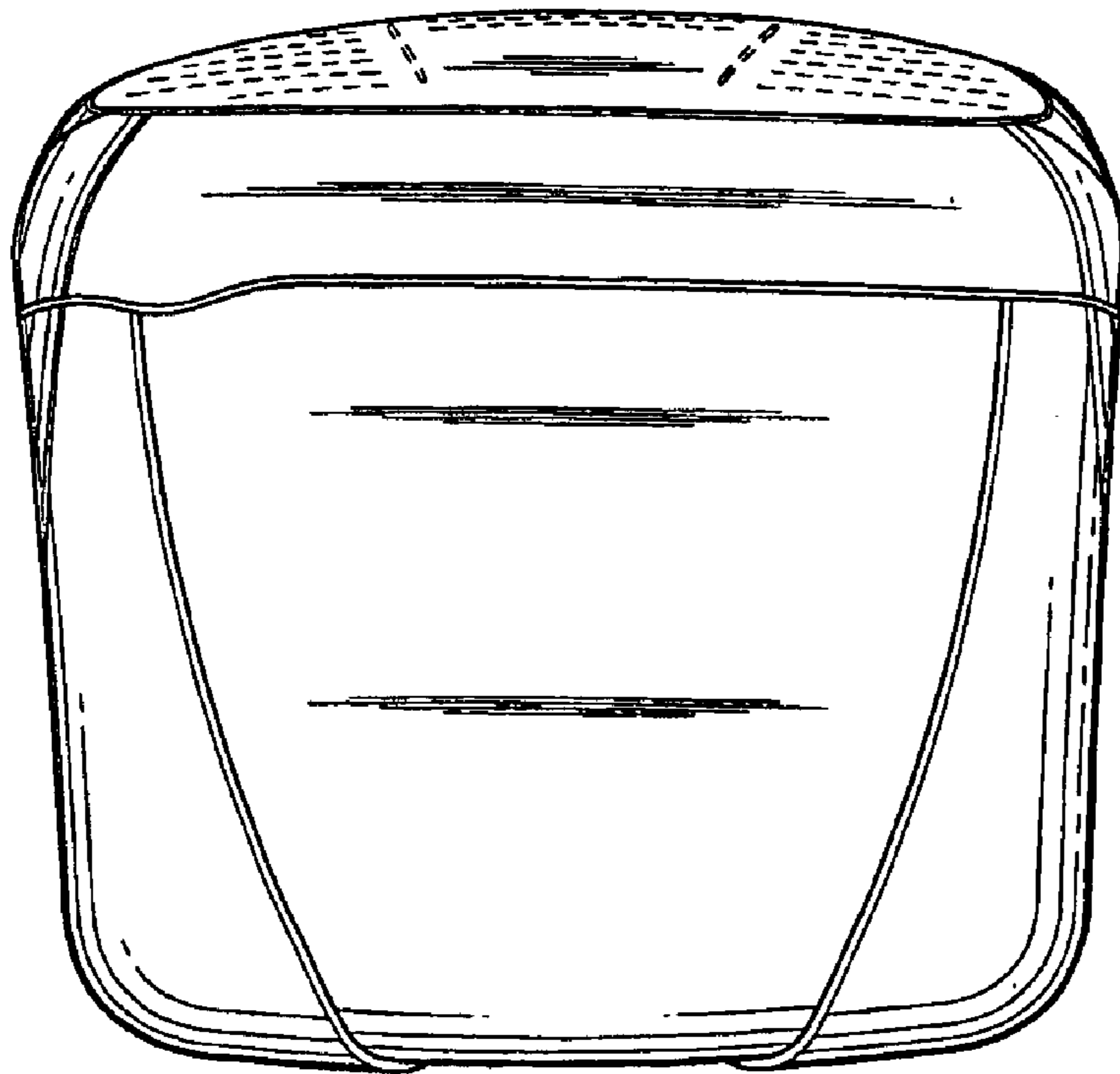

FIG. 2

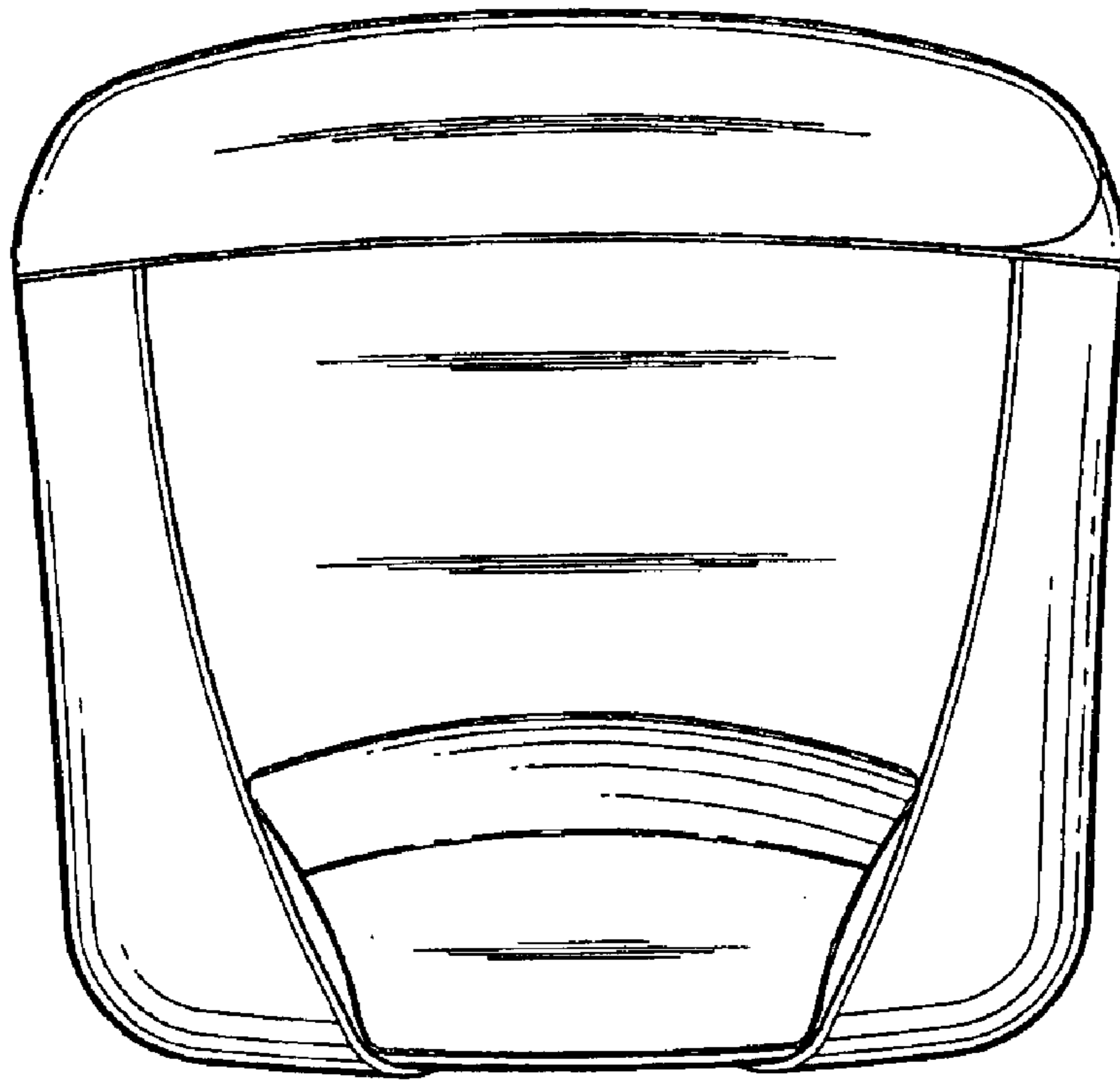

FIG. 3

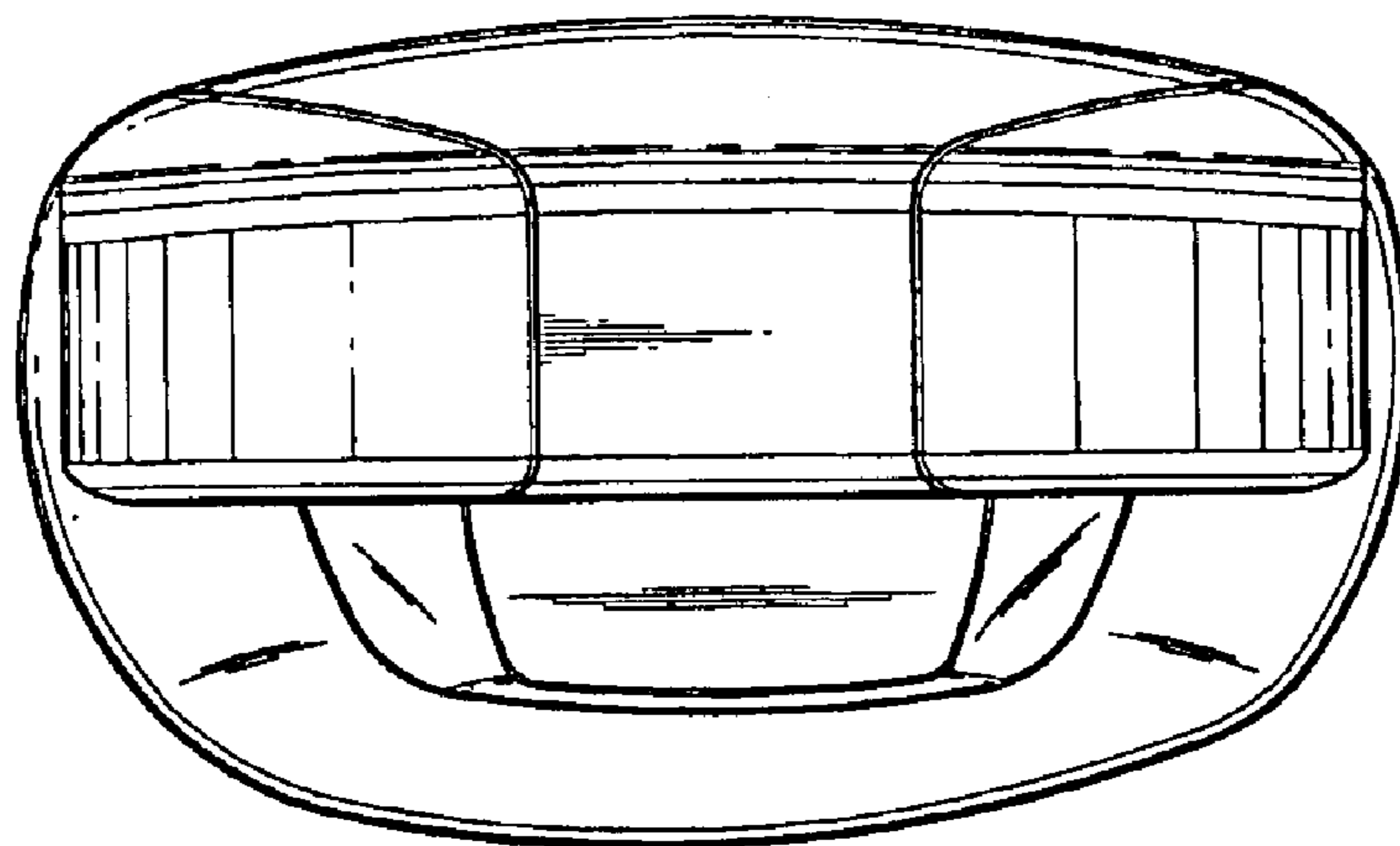

FIG. 4

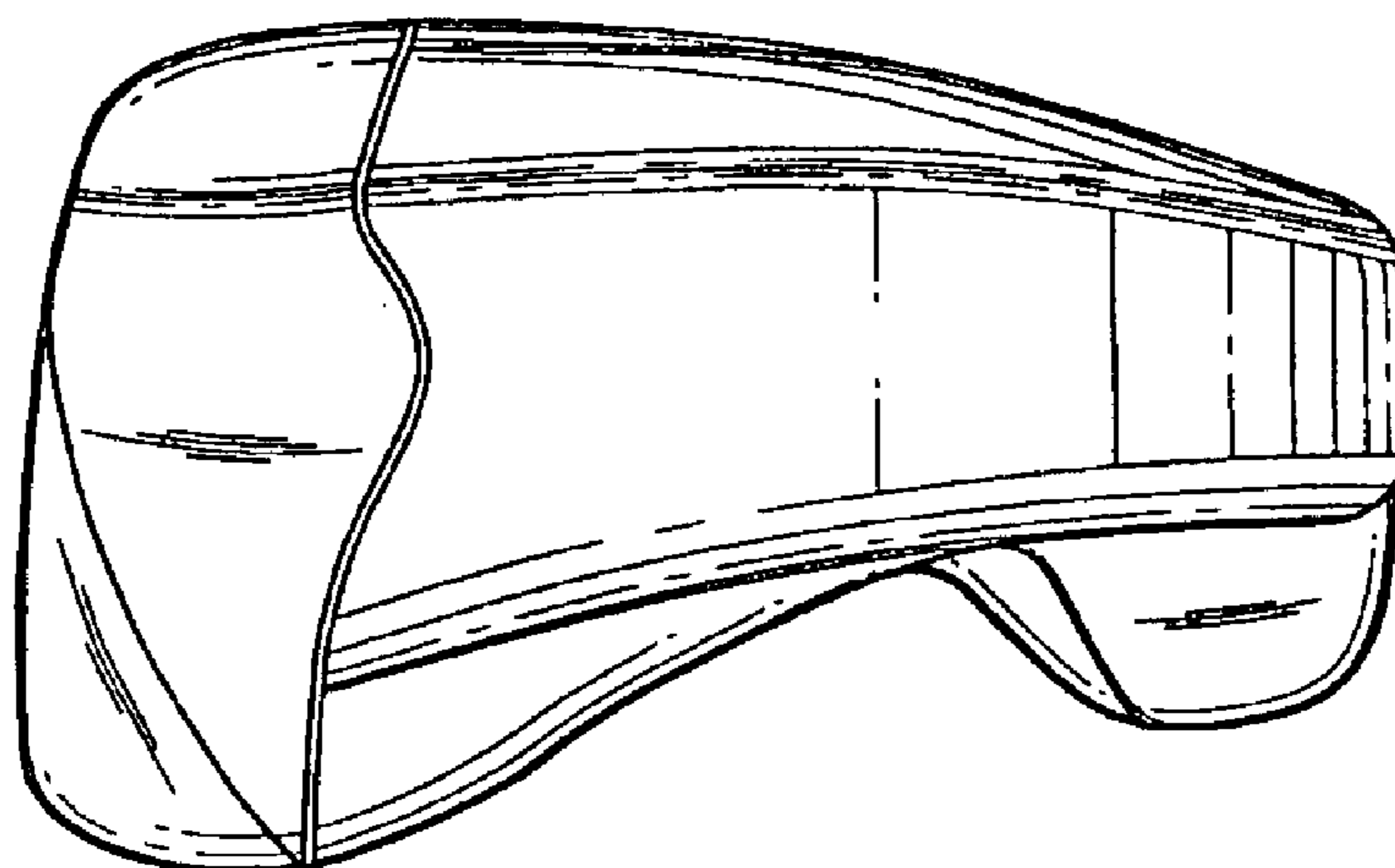

FIG. 5

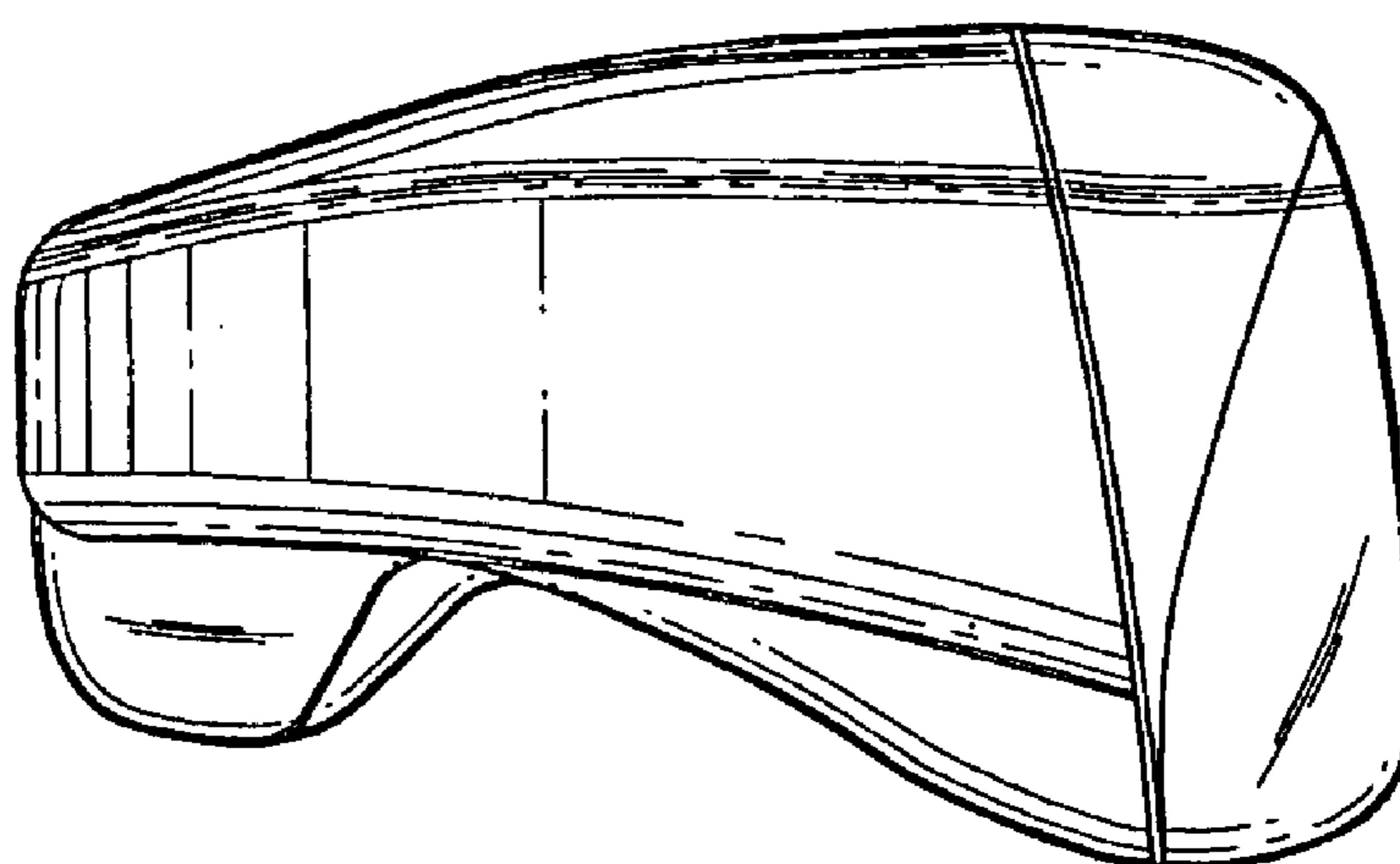

FIG. 6