

US00D524378S

(12) **United States Design Patent**  
**Salcido**

(10) **Patent No.:** **US D524,378 S**

(45) **Date of Patent:** **\*\* Jul. 4, 2006**

(54) **CHANGEABLE INDICATOR**

D301,721 S \* 6/1989 Myshyniuk ..... D20/10  
5,822,900 A 10/1998 Armstrong  
6,233,858 B1 5/2001 Brach, Jr. et al.

(76) **Inventor:** **Cayetano F. Salcido**, 3125 Kessler Ave., Midland, TX (US) 79701

\* cited by examiner

(\*\*) **Term:** **14 Years**

*Primary Examiner*—Antoine D. Davis

*Assistant Examiner*—Patricia Palasik

(21) **Appl. No.:** **29/216,733**

(74) *Attorney, Agent, or Firm*—Stephen R. Greiner

(22) **Filed:** **Nov. 9, 2004**

(57) **CLAIM**

(51) **LOC (8) Cl.** ..... **20-02**

The ornamental design for a changeable indicator, as shown and described.

(52) **U.S. Cl.** ..... **D20/10**

(58) **Field of Classification Search** ..... D20/10,  
D20/40, 42; 40/489, 490, 606, 607, 607.01,  
40/611.01, 611, 612, 618, 620, 649, 651,  
40/660, 661.03, 503, 506; 403/353; 248/218.4  
See application file for complete search history.

**DESCRIPTION**

FIG. 1 is a perspective view of a changeable indicator showing my new design;  
FIG. 2 is a top view thereof;  
FIG. 3 is a right side elevational view thereof;  
FIG. 4 is a bottom view thereof;  
FIG. 5 is a front elevational view thereof;  
FIG. 6 is a left side elevational view thereof; and,  
FIG. 7 is a rear elevational view thereof.  
The broken line showing of printed indicia in FIGS. 1, 5 and 7 is for demonstrative purposes only and forms no part of the claimed design.

(56) **References Cited**

**U.S. PATENT DOCUMENTS**

983,289 A	2/1911	Kirby	
1,502,185 A	7/1924	Gray	
1,803,598 A *	5/1931	Craig	40/432
2,841,899 A	7/1958	Renfrow	
2,856,714 A *	10/1958	Bruner	40/503
3,008,247 A	11/1961	Gaumond	
3,883,968 A *	5/1975	Suzuki	40/506
D290,378 S *	6/1987	Anderson	D20/10

**1 Claim, 2 Drawing Sheets**

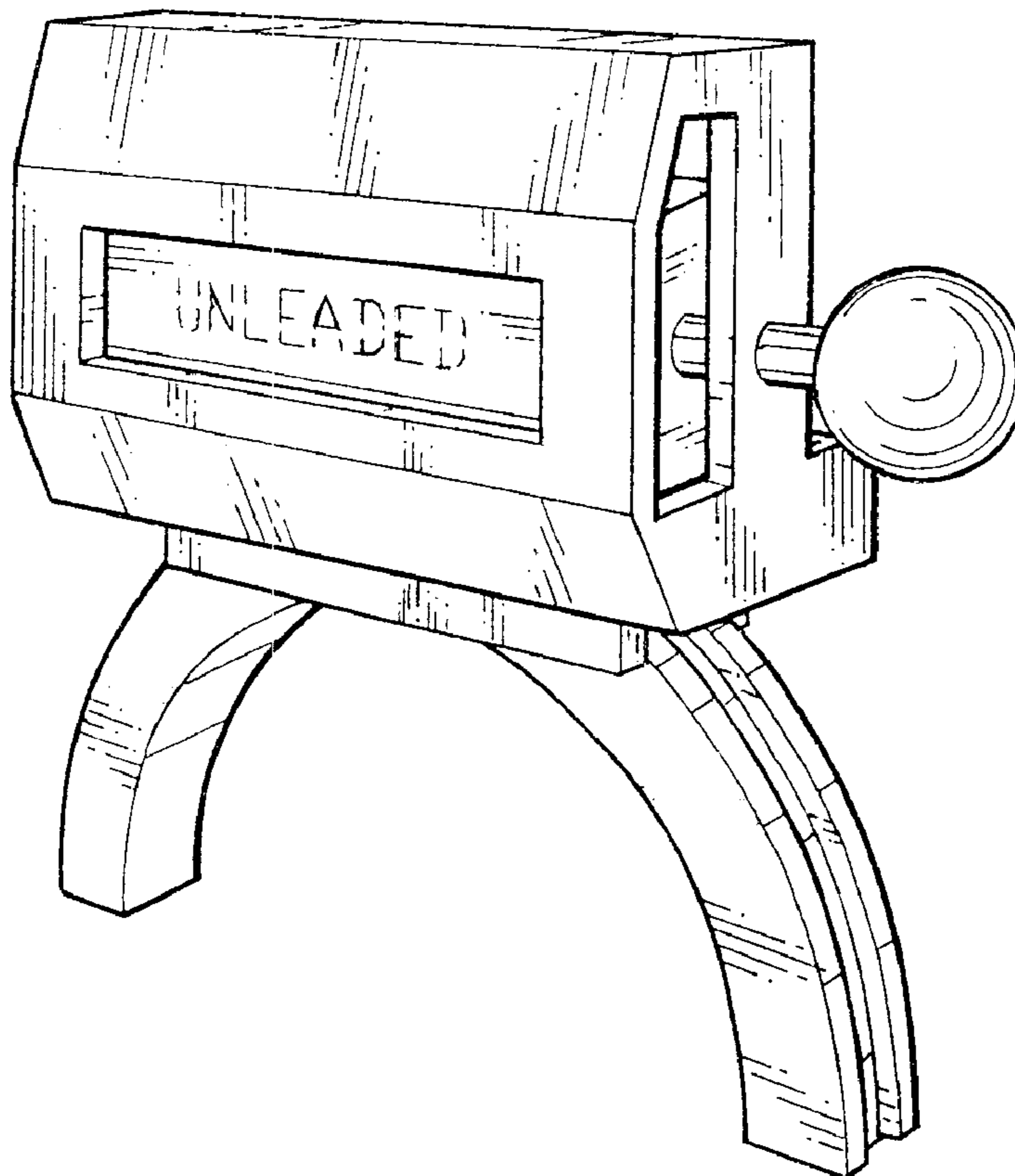

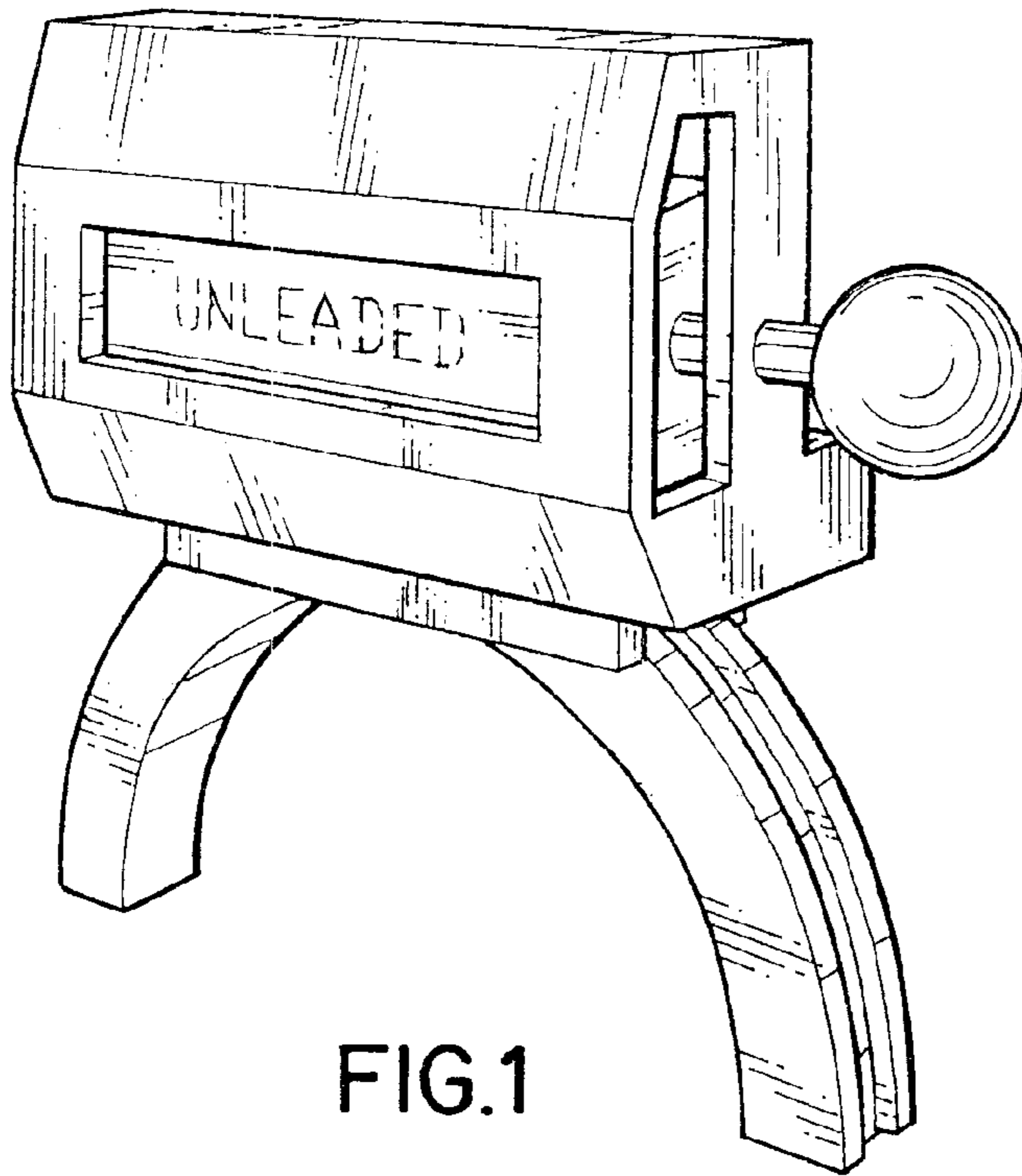

FIG. 1

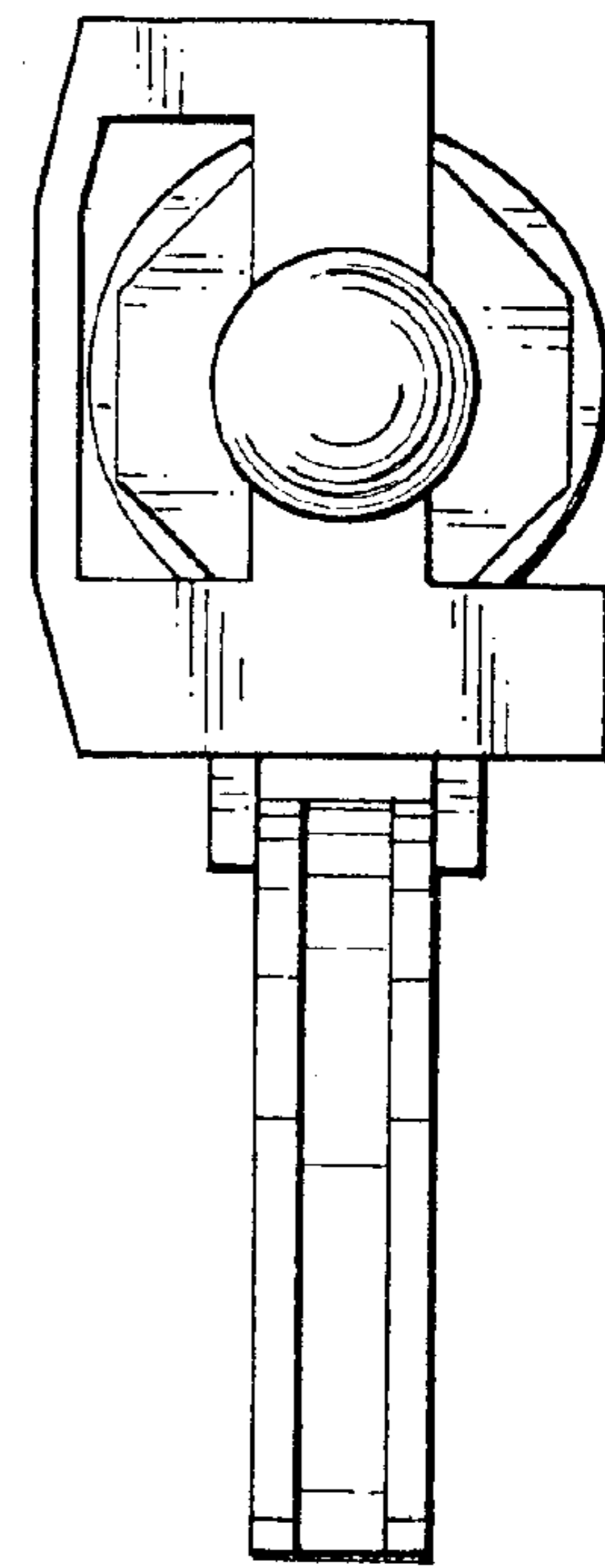

FIG. 3

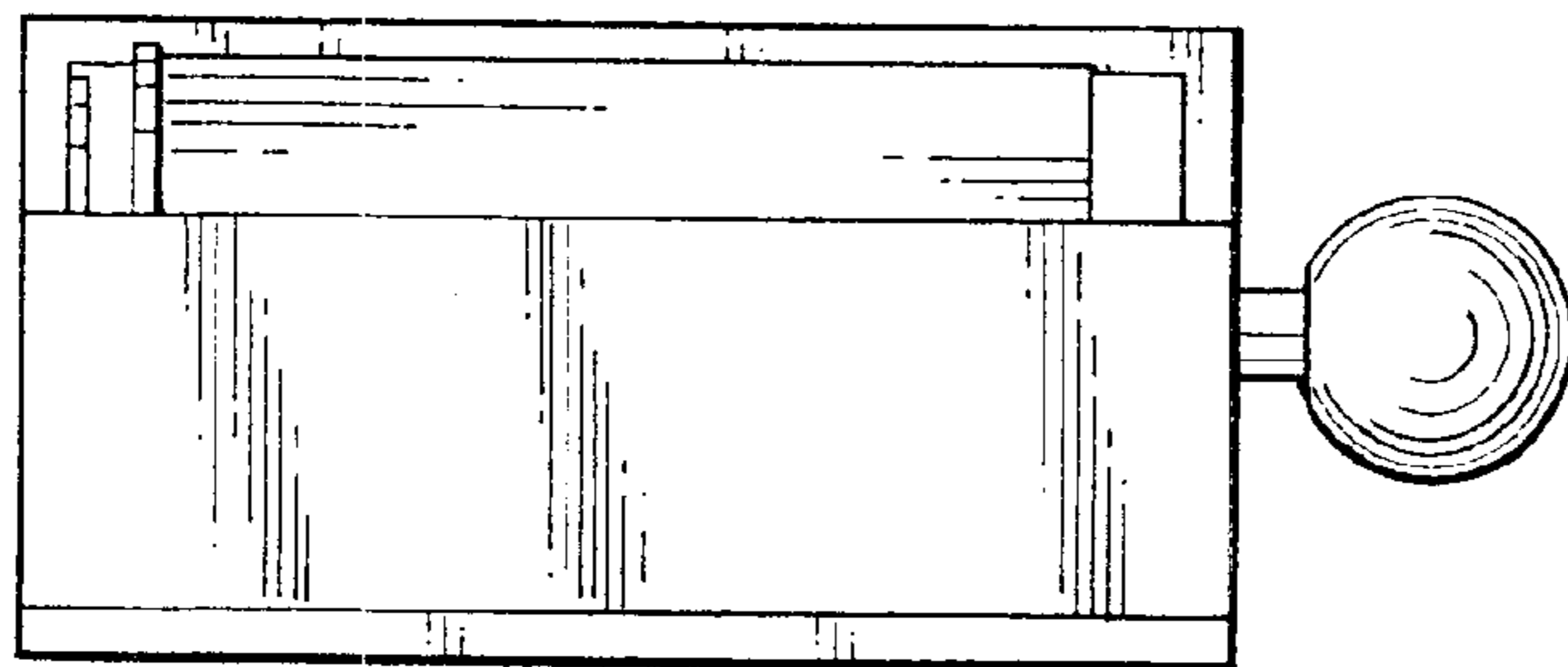

FIG. 2

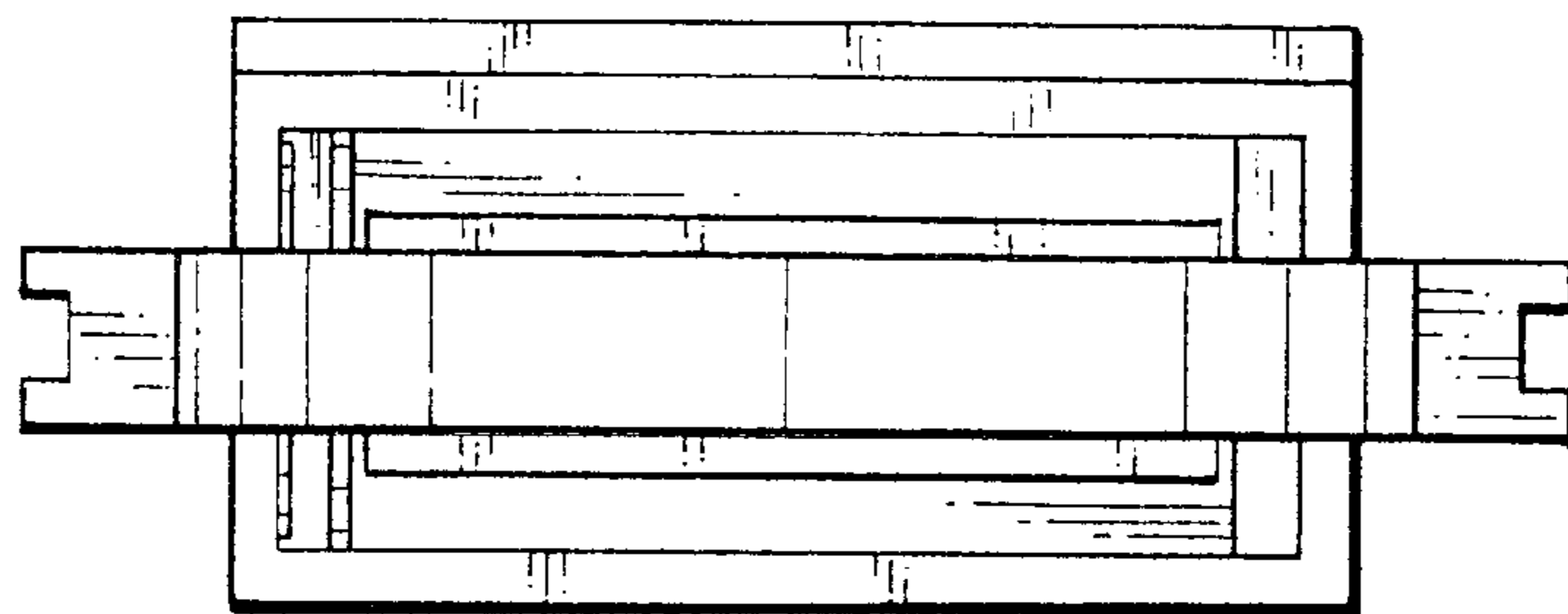

FIG. 4

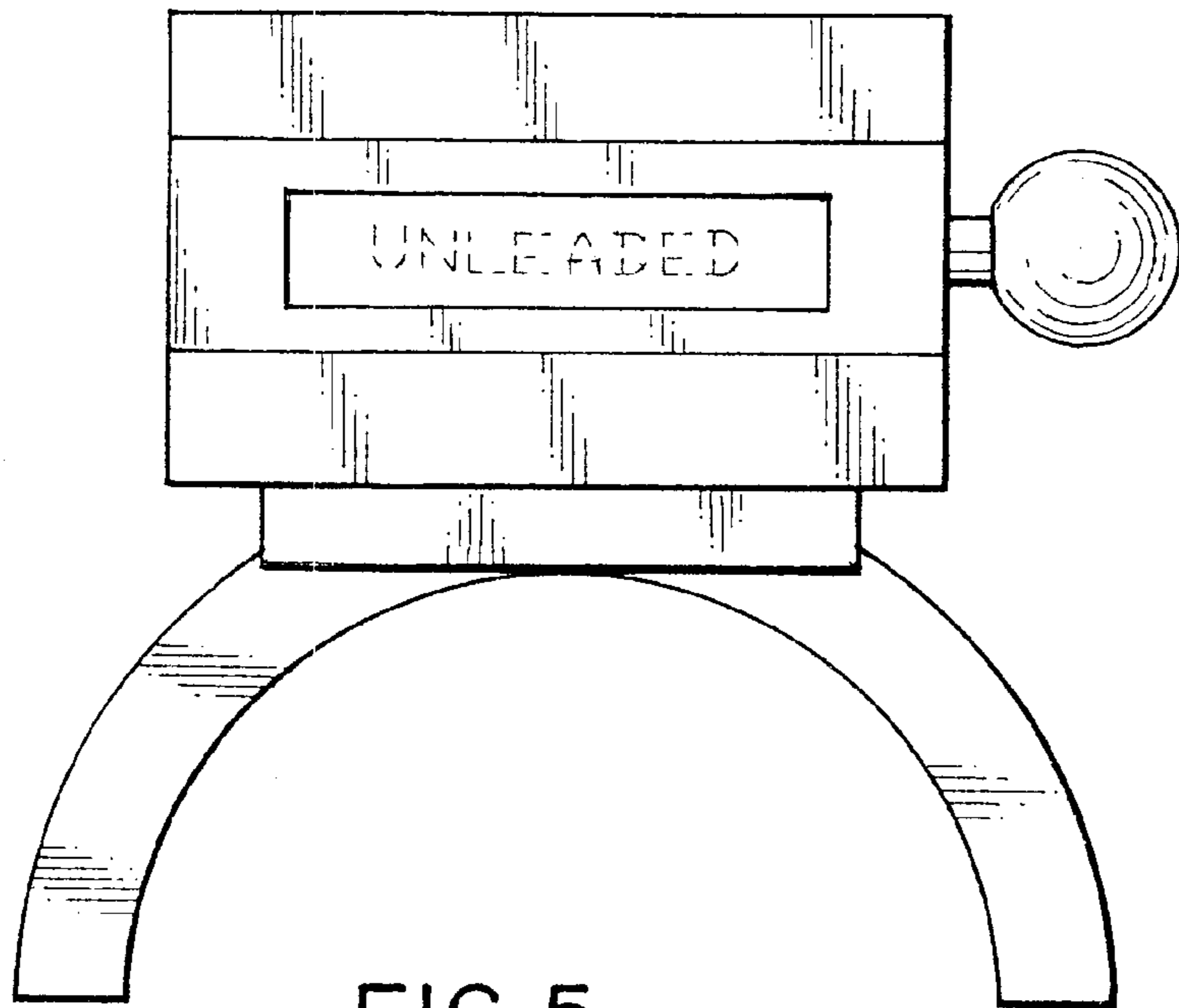

FIG. 5

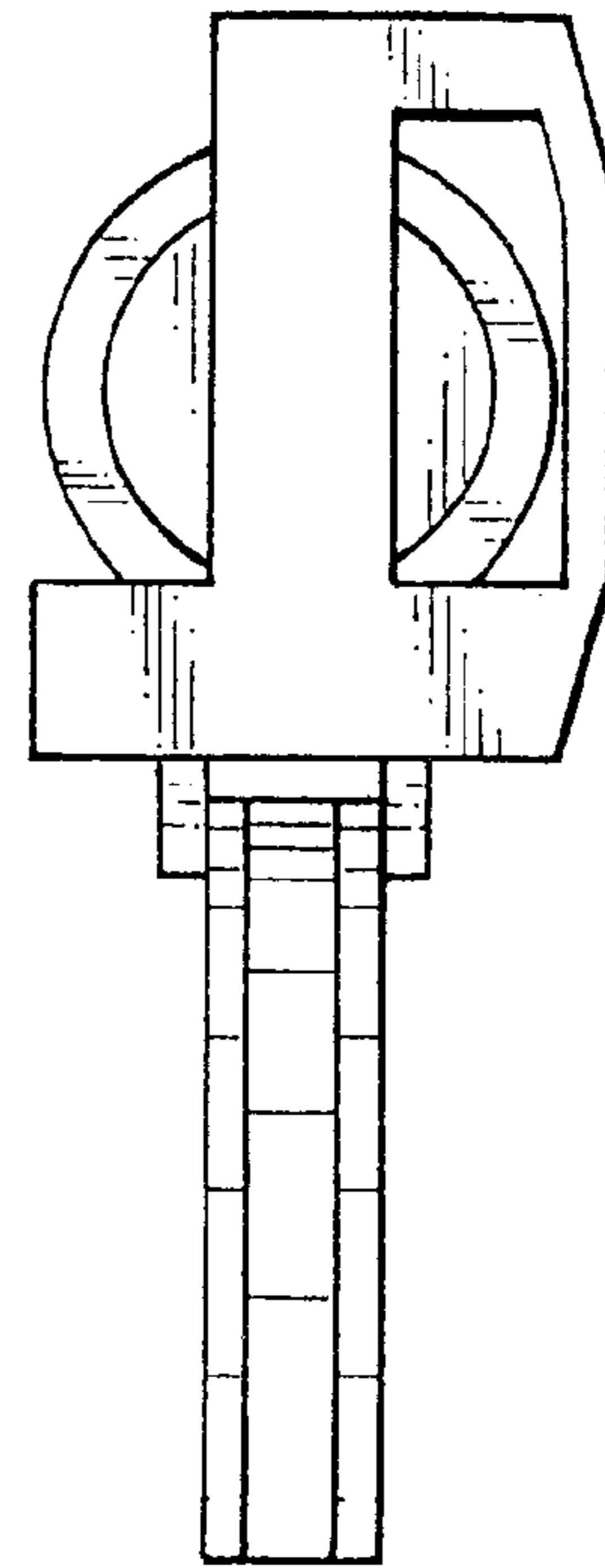

FIG. 6

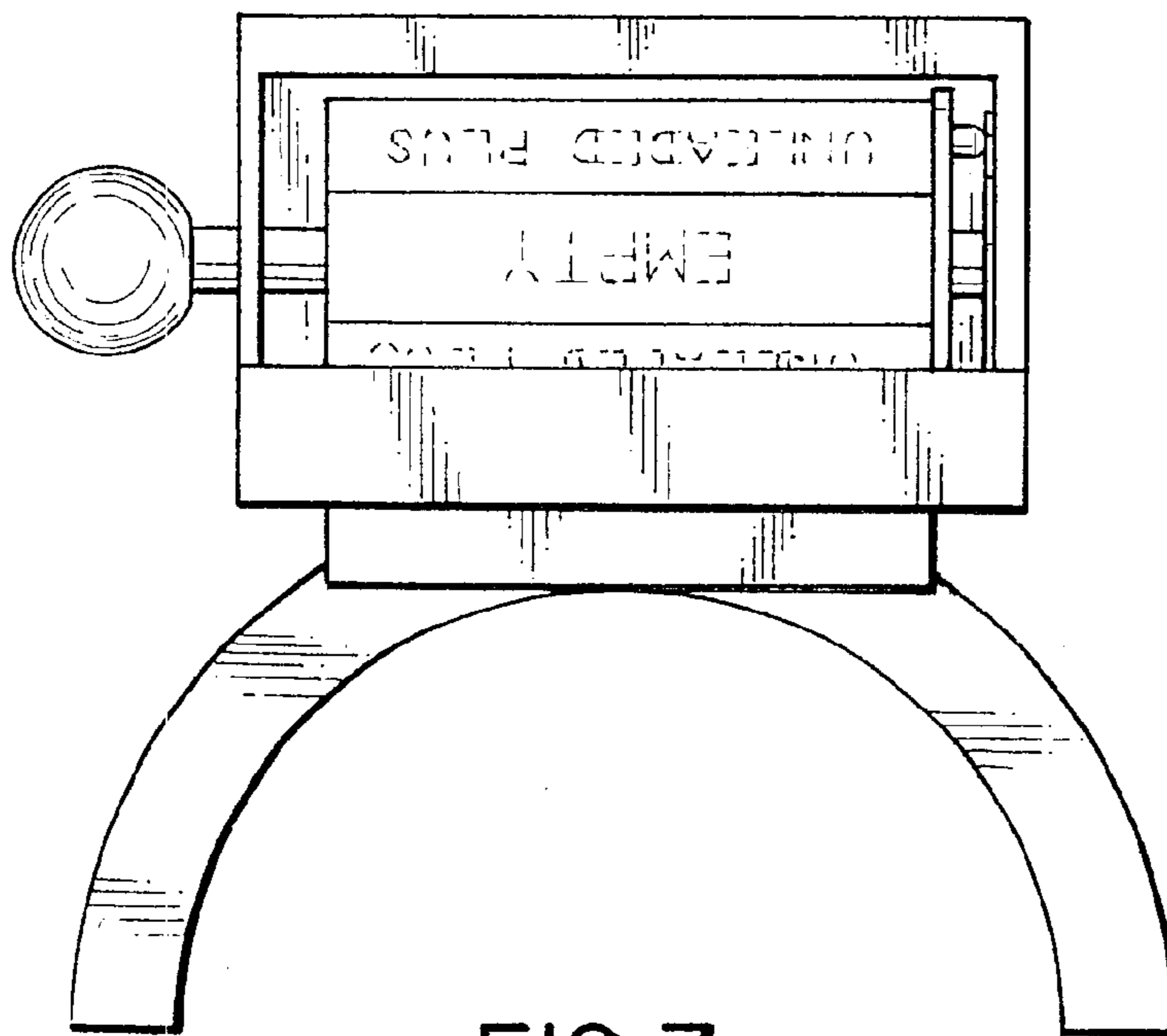

FIG. 7