

US00D524375S

(12) **United States Design Patent** (10) **Patent No.:** **US D524,375 S**
Carlson et al. (45) **Date of Patent:** ** ***Jul. 4, 2006**

(54) **TAPE DISPENSER**

(75) Inventors: **Casey L. Carlson**, Edina, MN (US);
Daniel E. Siltberg, White Bear
Township, MN (US); **Scott D. Gullicks**,
Apple Valley, MN (US); **Sigurdur**
Thorsteinsson, Milan (IT)

(73) Assignee: **3M Innovative Properties Company**,
St. Paul, MN (US)

(*) Notice: This patent is subject to a terminal dis-
claimer.

(**) Term: **14 Years**

(21) Appl. No.: **29/223,803**

(22) Filed: **Feb. 18, 2005**

Related U.S. Application Data

(63) Continuation-in-part of application No. 29/208,751, filed on
Jul. 2, 2004, now Pat. No. Des. 510,951.

(51) **LOC (8) Cl.** **19-02**

(52) **U.S. Cl.** **D19/69**

(58) **Field of Classification Search** D19/67,
D19/68, 69, 70; 156/523, 527, 577; 206/411;
225/6, 19, 25, 39, 77; 242/588.1, 588.2, 588.3,
242/588.6, 598.2, 598.5

See application file for complete search history.

(56) **References Cited**

U.S. PATENT DOCUMENTS

D116,599 S 9/1939 Reinecke
D118,629 S * 1/1940 Reinecke D19/69
D144,215 S 3/1946 Preble
D164,556 S 9/1951 Donkin

(Continued)

OTHER PUBLICATIONS

3M Product Pamphlet from 3M Office Supplies Division, A
World of Difference, New Products, "Scotch® Pop-up/Roll
Tape Combo Dispenser," p. 8, ©2002, printed in USA.

3M Product Pamphlet from 3M Office Supplies Division,
Working Solutions Working for You, "Scotch® Pop-up/Roll
Tape Combo Dispenser" p. 12, ©2003, printed in USA.

3M Product Pamphlet from 3M Stationery Products Divi-
sion, Scotch® Transparent Tape, (6-page tri-fold), ©2003,
printed in USA.

3M Product Pamphlet from 3M Stationery Products Divi-
sion, Scotch® Magic™ Tape, 2 pages, ©2002, printed in
USA.

3M Product Pamphlet from 3M Stationery Products Divi-
sion, Scotch® Gift Wrap Tape, 2 pages, ©2003, printed in
USA.

Scotch brand Pop-up/Roll Tape Combo dispenser and pack-
aging, manufactured by 3M Company, pp. 1-15. Product
was on sale prior to Jul. 2, 2003.

Primary Examiner—Elizabeth A. Albert

(74) *Attorney, Agent, or Firm*—Trisha D. Adamson

(57) **CLAIM**

The ornamental design for a tape dispenser, as shown and
described.

DESCRIPTION

FIG. 1 is a perspective view of a tape dispenser showing our
new design;

FIG. 2 is a left side view of the tape dispenser illustrated in
FIG. 1, the right side view being the mirror image thereof;
FIG. 3 is a top view of the tape dispenser illustrated in FIG.
1;

FIG. 4 is a bottom view of the tape dispenser illustrated in
FIG. 1;

FIG. 5 is a front view of the tape dispenser illustrated in FIG.
1; and,

FIG. 6 is a rear view of the tape dispenser illustrated in FIG.
1.

The structure depicted by means of broken lines in the
figures has been shown for illustrative purposes only and
forms no part of the claimed design.

The drawings are lined for color; specifically the cross-
hatched lines represent yellow or gold coloring and the
elliptical shaped area surrounding the central hole without
lining represents white coloring.

1 Claim, 2 Drawing Sheets

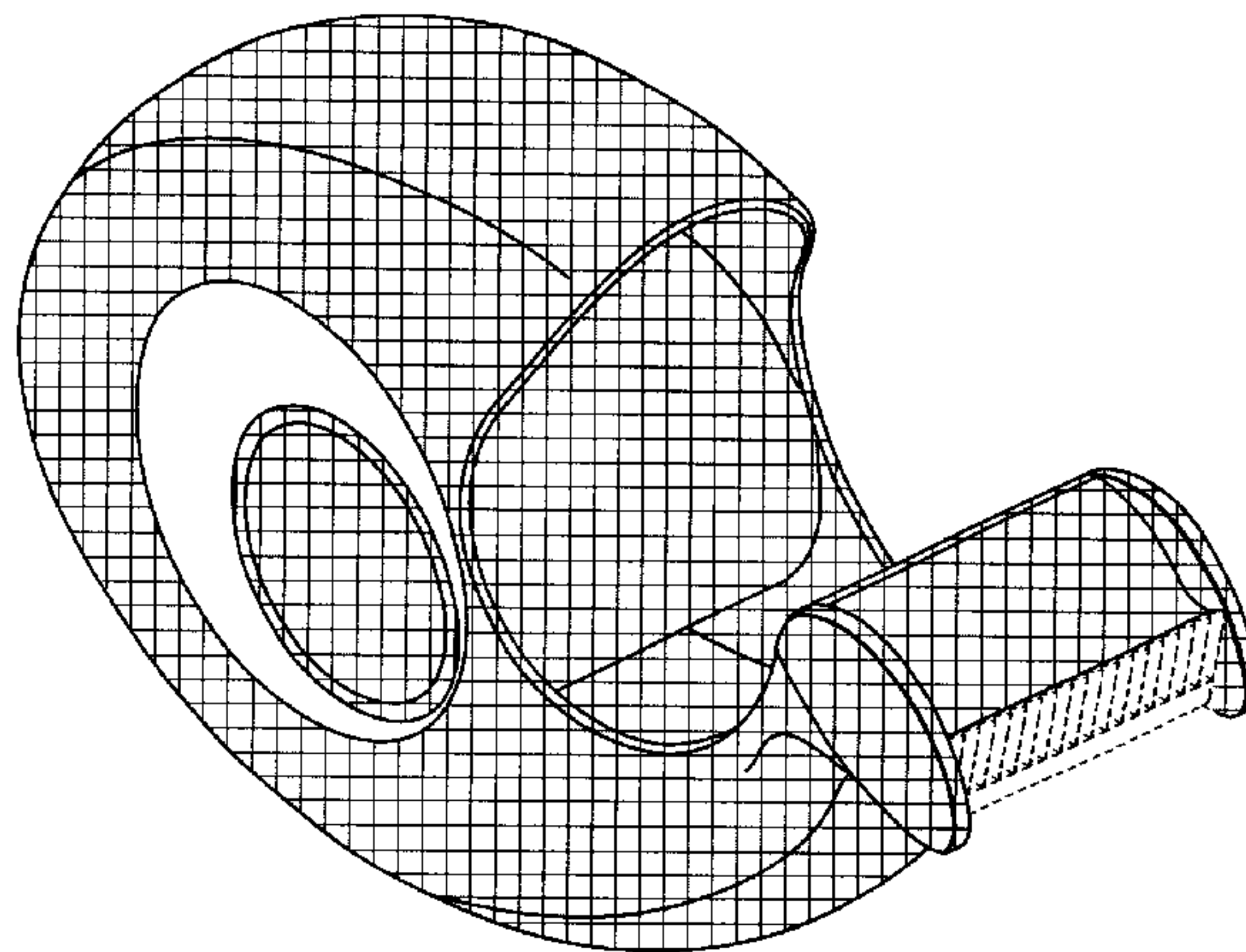

US D524,375 S

Page 2

U.S. PATENT DOCUMENTS

2,604,166	A	7/1952	Turner	
D170,429	S	* 9/1953	Reinecke D19/69
D177,224	S	3/1956	Gershen	
3,498,512	A	* 3/1970	Golemon 225/21
D242,452	S	* 11/1976	Brown D19/69
4,437,854	A	* 3/1984	Knoop 493/353
4,824,427	A	* 4/1989	Smillie, III 493/353
D315,576	S	* 3/1991	En D19/69
5,083,717	A	* 1/1992	Samuelson et al. 242/588.6
D331,262	S	* 11/1992	O'Brien D19/69
D332,629	S	* 1/1993	OH D19/69
D336,492	S	6/1993	Samuelson	
D342,092	S	* 12/1993	Samuelson et al. D19/69
D342,093	S	* 12/1993	Samuelson D19/69
5,370,916	A	* 12/1994	Olsen 428/40.1
5,794,815	A	8/1998	Carlson et al.	
5,964,375	A	10/1999	Carlson et al.	
5,996,932	A	* 12/1999	Wang 242/598.5
6,460,800	B1	* 10/2002	Watanabe et al. 242/598.5
D485,578	S	* 1/2004	Chandaria D19/69
2004/0124305	A1	* 7/2004	Huang 242/588.6
2004/0151901	A1	* 8/2004	Pearson et al. 428/343

* cited by examiner

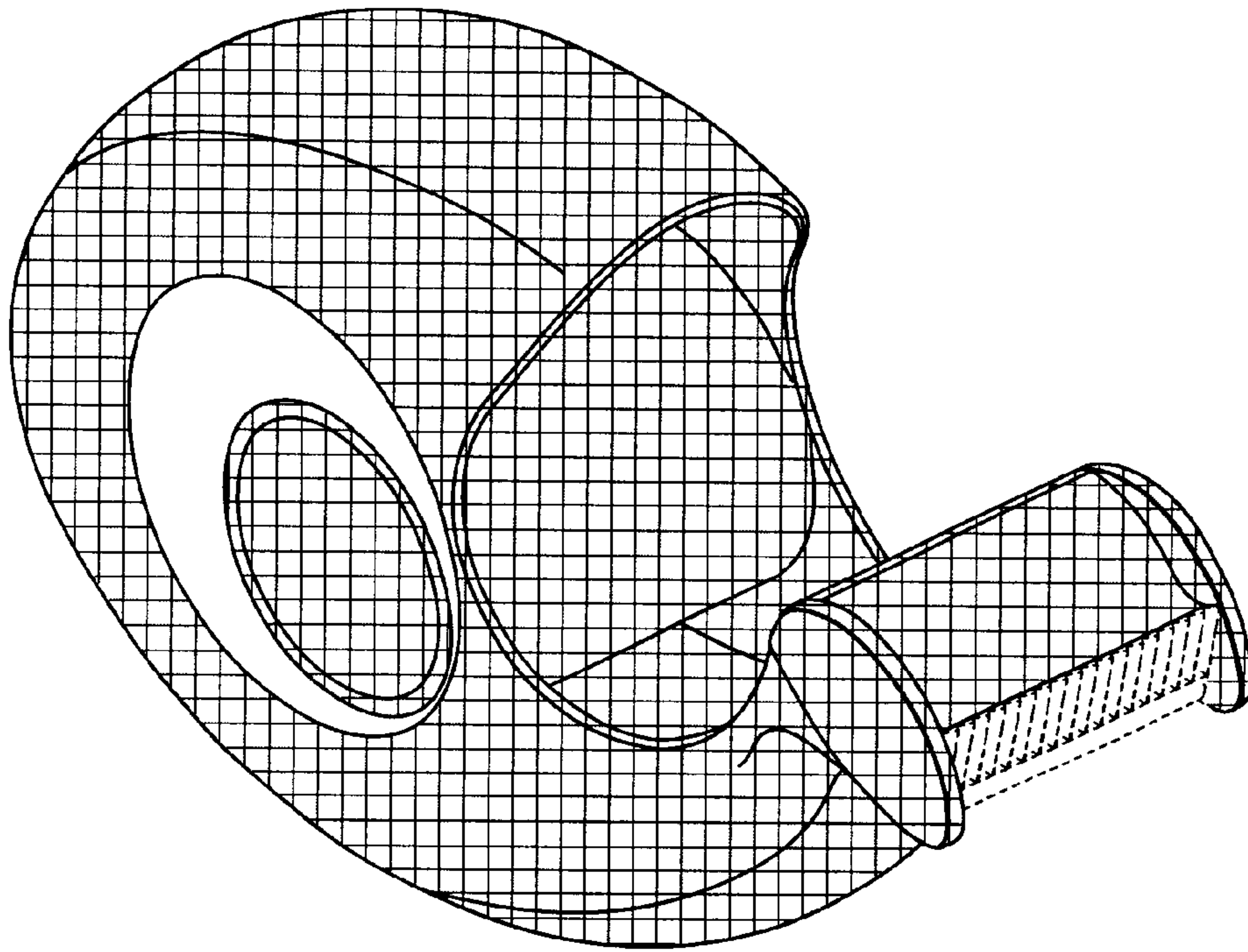

Fig. 1

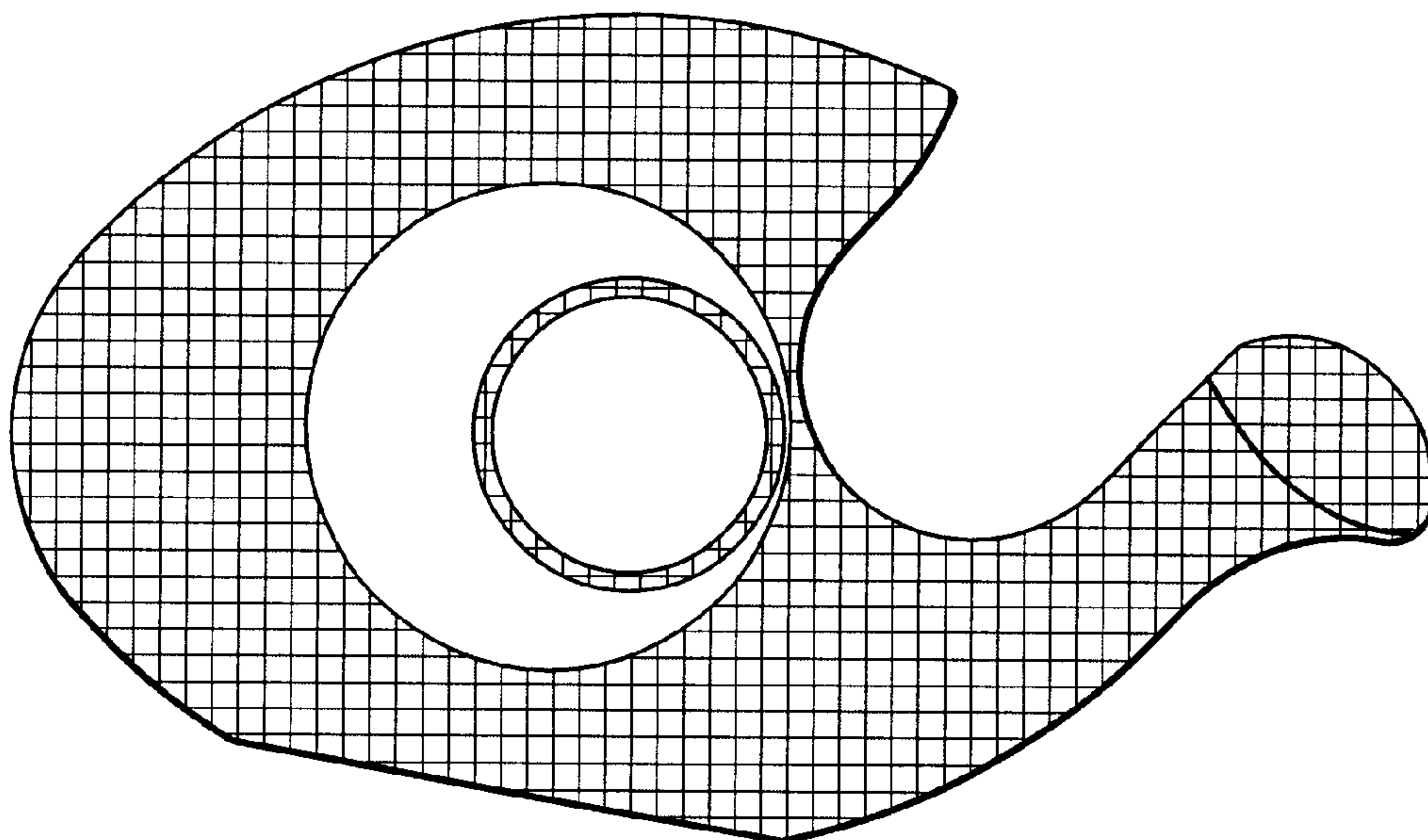

Fig. 2

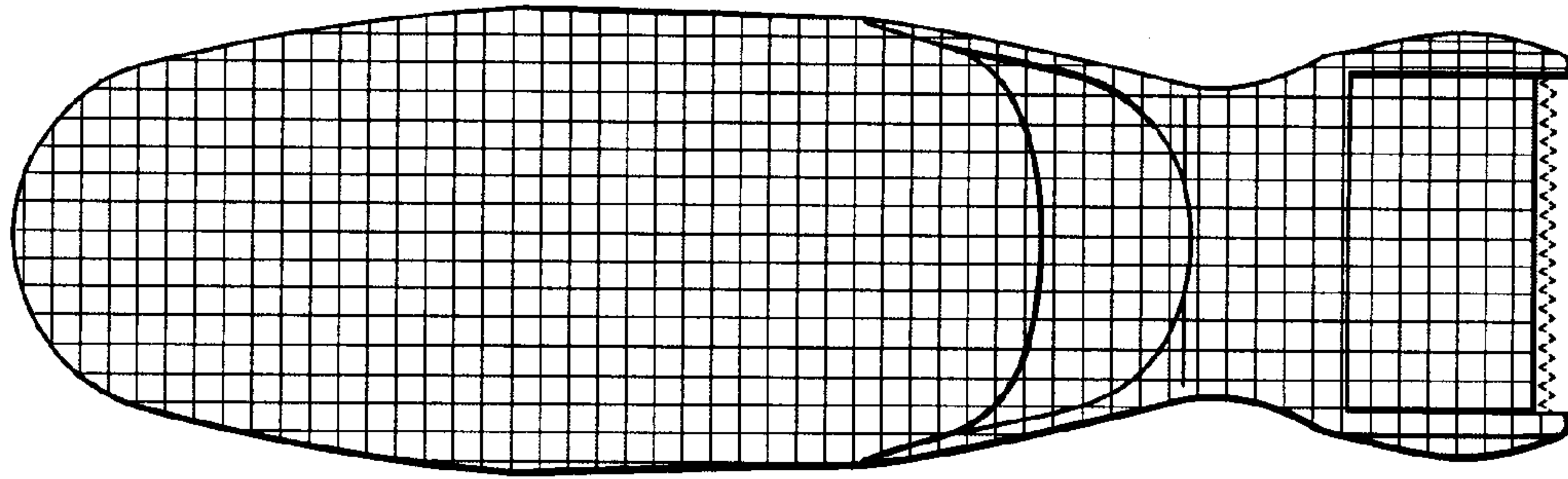

Fig. 3

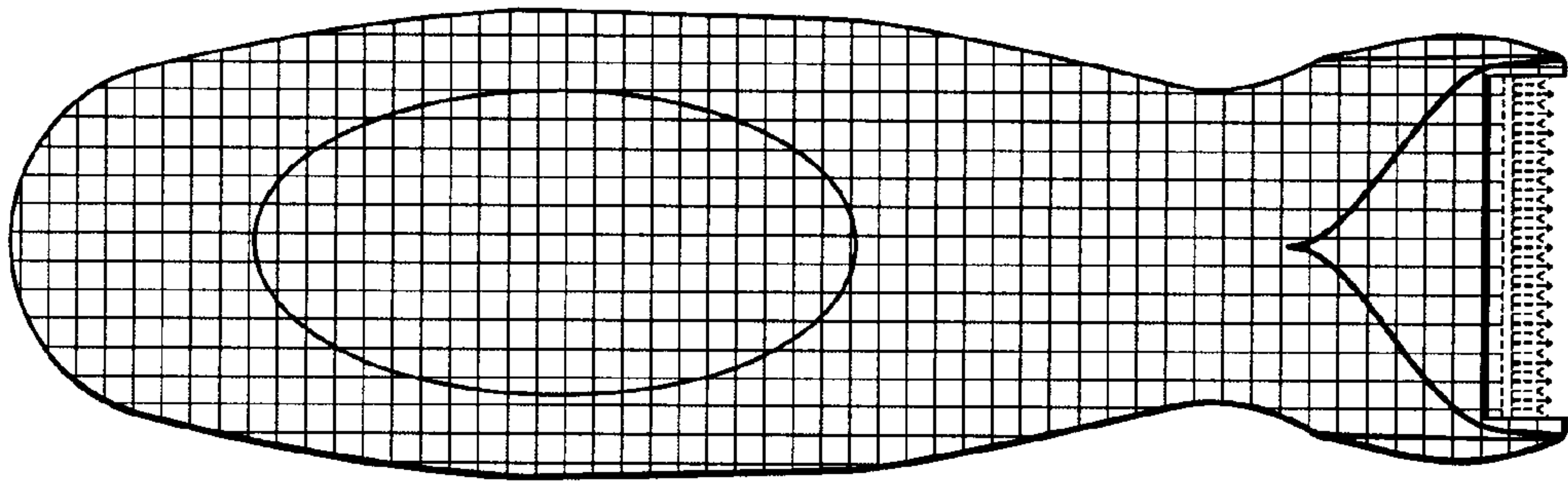

Fig. 4

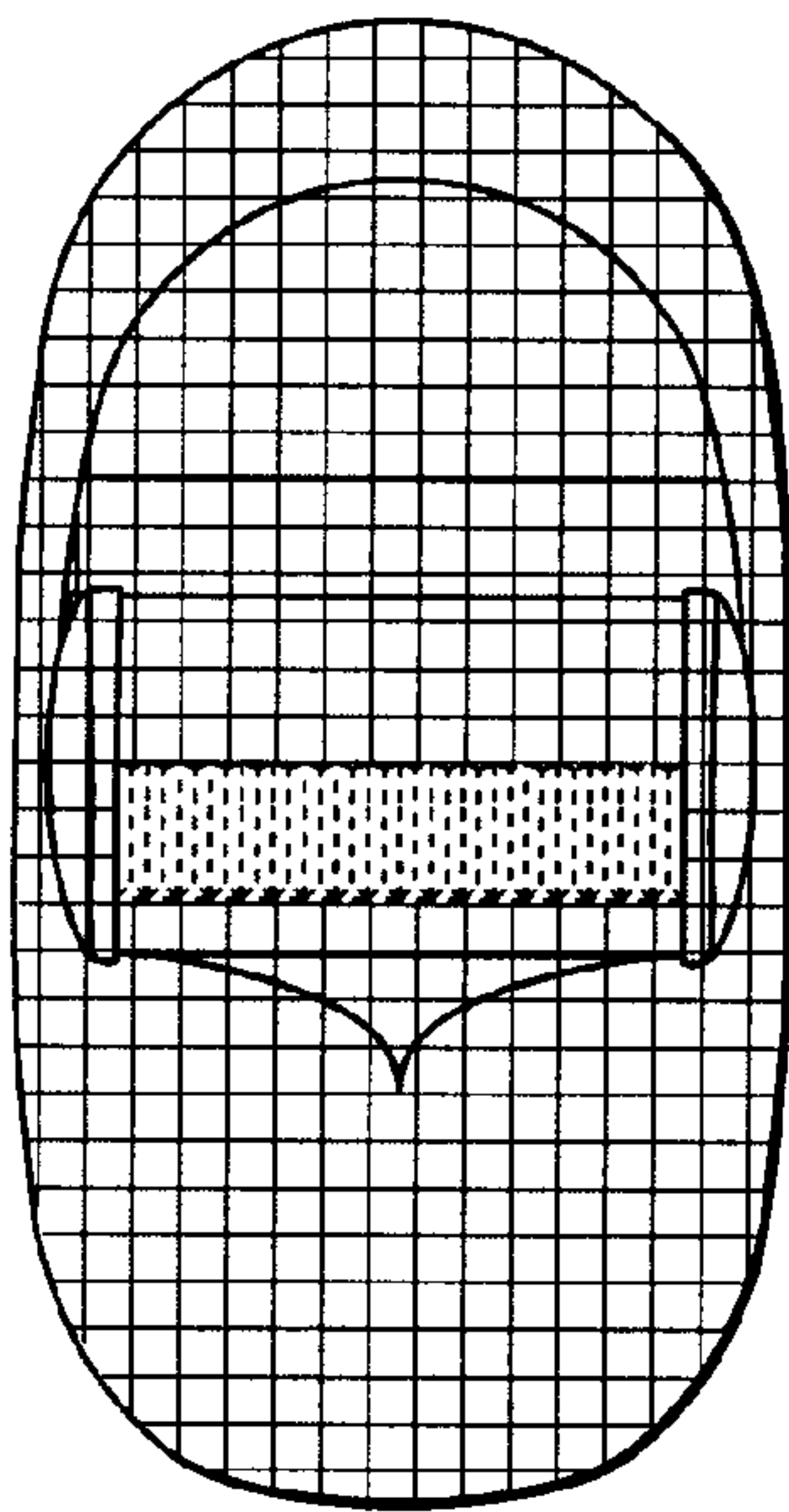

Fig. 5

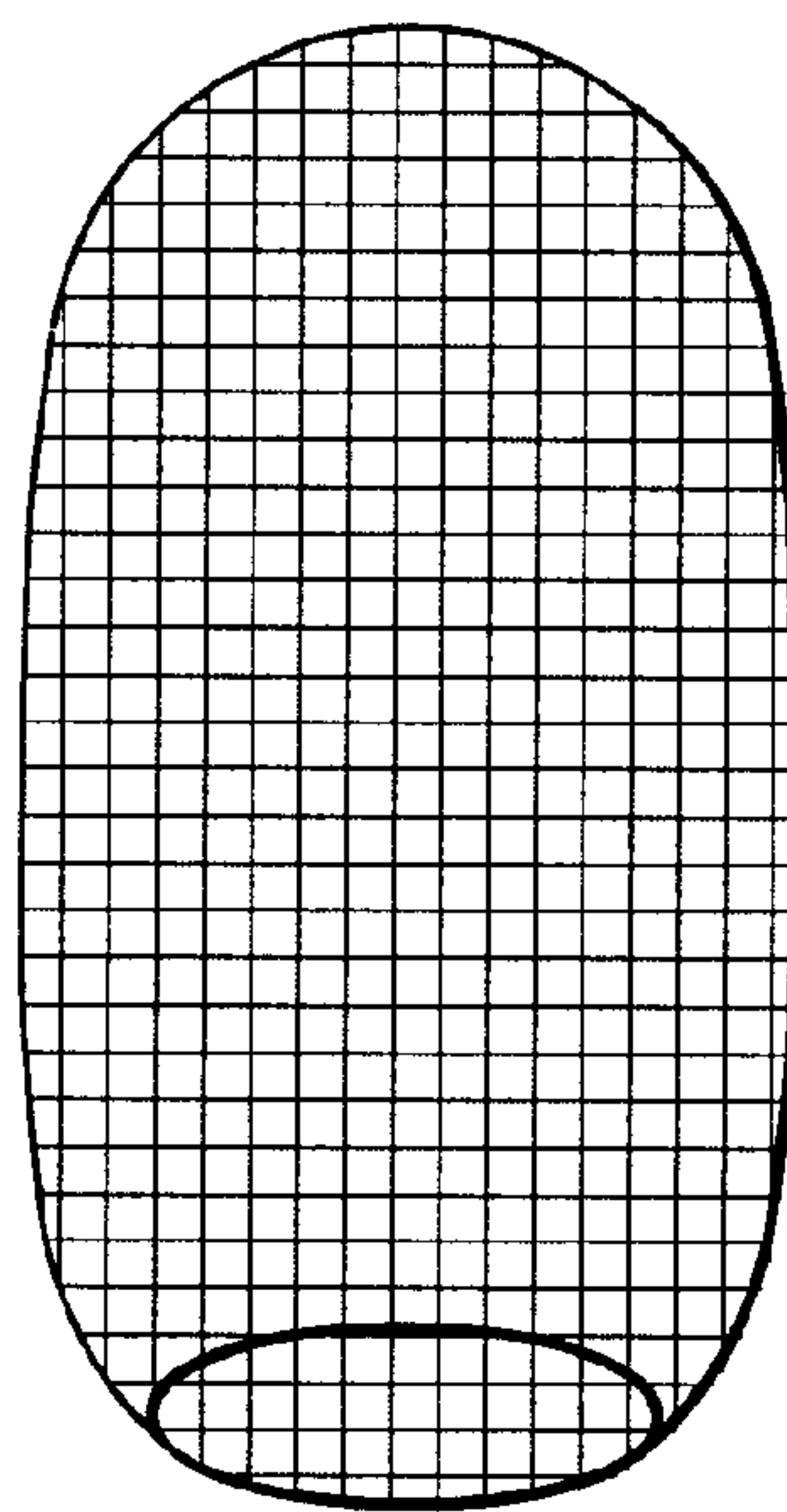

Fig. 6