

US00D524374S

(12) **United States Design Patent** (10) **Patent No.:** **US D524,374 S**
Carlson et al. (45) **Date of Patent:** **** *Jul. 4, 2006**

(54) **TAPE DISPENSER**

(75) Inventors: **Casey L. Carlson**, Edina, MN (US);
Daniel E. Siltberg, White Bear
Township, MN (US); **Scott D. Gullicks**,
Apple Valley, MN (US); **Sigurdur**
Thorsteinsson, Milan (IT)

(73) Assignee: **3M Innovative Properties Company**,
St. Paul, MN (US)

(*) Notice: This patent is subject to a terminal dis-
claimer.

(**) Term: **14 Years**

(21) Appl. No.: **29/223,801**

(22) Filed: **Feb. 18, 2005**

Related U.S. Application Data

(63) Continuation-in-part of application No. 29/208,731, filed on
Jul. 2, 2004, now Pat. No. Des. 510,951.

(51) **LOC (8) Cl.** **19-02**

(52) **U.S. Cl.** **D19/69**

(58) **Field of Classification Search** D19/67,
D19/68, 69, 70; 156/523, 527, 577; 206/411;
225/6, 19, 25, 39, 77; 242/588.1, 588.2, 588.3,
242/588.6, 592.2, 598.5

See application file for complete search history.

(56) **References Cited**

U.S. PATENT DOCUMENTS

D116,599 S	9/1939	Reinecke	
D118,629 S	1/1940	Reinecke	
D144,215 S	3/1946	Preble	
D164,556 S	9/1951	Donkin	
2,604,166 A *	7/1952	Turner	83/611

(Continued)

OTHER PUBLICATIONS

3M Product Pamphlet from 3M Office Supplies Division, A
World of Difference, New Products, "Scotch® Pop-up/Roll
Tape Combo Dispenser," p. 8, ©2002, printed in USA.

3M Product Pamphlet from 3M Office Supplies Division,
Working Solutions Working for You, "Scotch® Pop-up/Roll
Tape Combo Dispenser," p. 12, ©2003, printed in USA.

3M Product Pamphlet from 3M Stationery Products Divi-
sion, Scotch® Transparent Tape, (6-page tri-fold), ©2003,
printed in USA.

3M Product Pamphlet from 3M Stationery Products Divi-
sion, Scotch® Magic™ Tape, 2 pages, ©2002, printed in
USA.

3M Product Pamphlet from 3M Stationery Products Divi-
sion, Scotch® Gift Wrap Tape, 2 pages, ©2003, printed in
USA.

Scotch brand Pop-up/Roll Tape Combo dispenser and pack-
aging, manufactured by 3M Company, pp. 1-15. Product
was on sale prior to Jul. 2, 2003.

Primary Examiner—Elizabeth A. Albert

(74) *Attorney, Agent, or Firm*—Trisha D. Adamson

(57) **CLAIM**

The ornamental design for a tape dispenser, as shown and
described.

DESCRIPTION

FIG. 1 is a perspective view of a tape dispenser showing our
new design;

FIG. 2 is a left side view of the tape dispenser illustrated in
FIG. 1, the right side view being the mirror image thereof;
FIG. 3 is a top view of the tape dispenser illustrated in FIG.

1;

FIG. 4 is a bottom view of the tape dispenser illustrated in
FIG. 1;

FIG. 5 is a front view of the tape dispenser illustrated in FIG.
1; and,

FIG. 6 is a rear view of the tape dispenser illustrated in FIG.
1.

The structure depicted by means of broken lines in the
figures has been shown for illustrative purposes only and
forms no part of the claimed design.

The drawings are lined for color; specifically the vertical
lines represent red or pink coloring and the elliptical shaped
area surrounding the central hole without lining represents
white coloring.

1 Claim, 2 Drawing Sheets

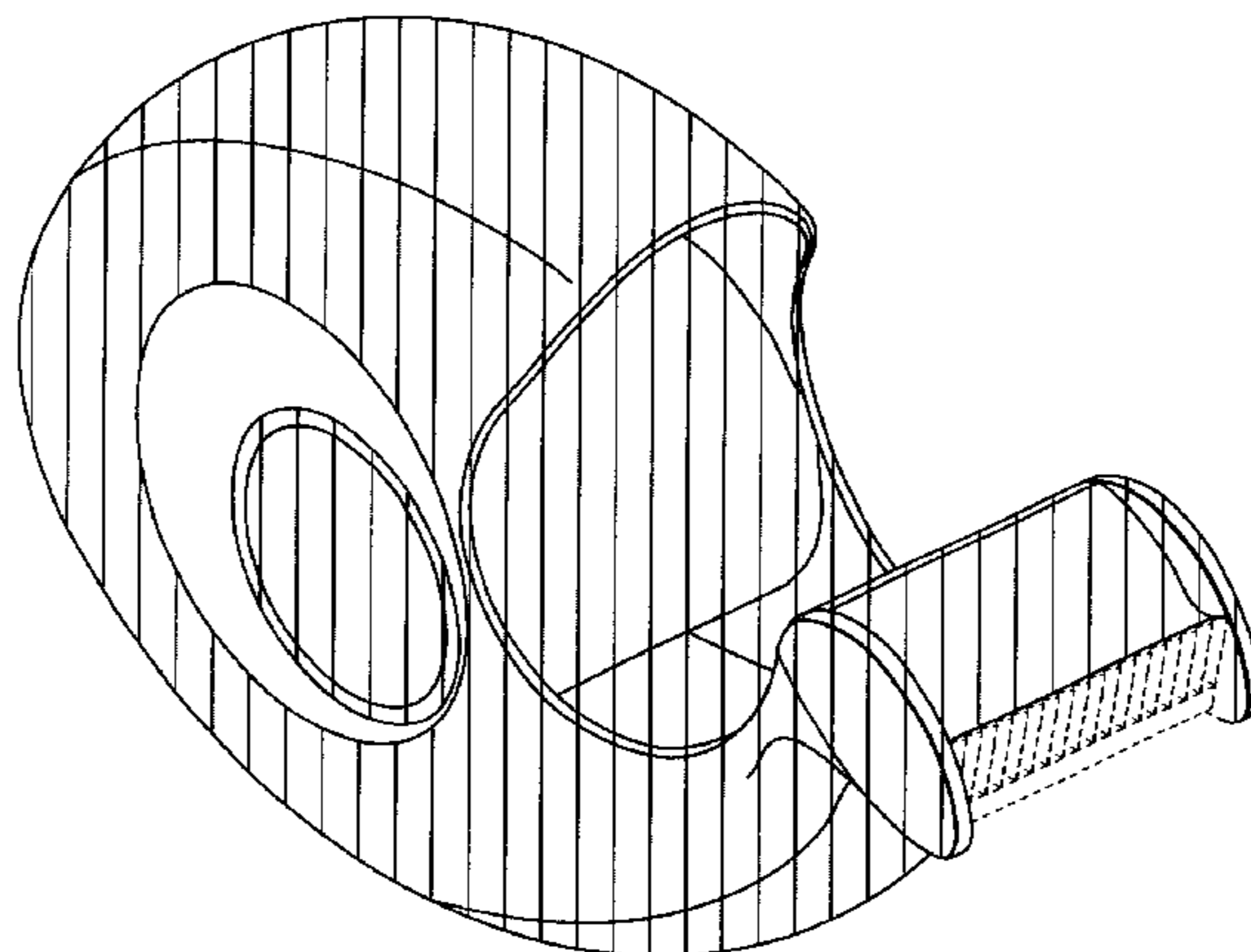

US D524,374 S

Page 2

U.S. PATENT DOCUMENTS

D170,429 S	9/1953	Reinecke			
D177,224 S	3/1956	Gershen			
3,498,512 A *	3/1970	Golemon	225/21	
D242,452 S *	11/1976	Brown, Sr.	D19/69	
4,437,854 A *	3/1984	Knoop	493/353	
4,824,427 A *	4/1989	Smillie, III	493/353	
D315,576 S	3/1991	En			
5,083,717 A *	1/1992	Samuelson et al.	242/588.6	
D331,262 S *	11/1992	O'Brien	D19/69	
D332,629 S *	1/1993	OH	D19/69	
D336,492 S	6/1993	Samuelson			
D342,092 S	12/1993	Samuelson			
D342,093 S	12/1993	Samuelson			
5,370,916 A *	12/1994	Olsen	428/40.1	
5,794,815 A	8/1998	Carlson et al.			
5,964,375 A	10/1999	Carlson et al.			
5,996,932 A *	12/1999	Wang	242/598.5	
6,460,800 B1 *	10/2002	Watanabe et al.	242/598.5	
D485,578 S *	1/2004	Chandaria	D19/69	
2004/0124305 A1 *	7/2004	Huang	242/588.6	
2004/0151901 A1 *	8/2004	Pearson et al.	428/343	

* cited by examiner

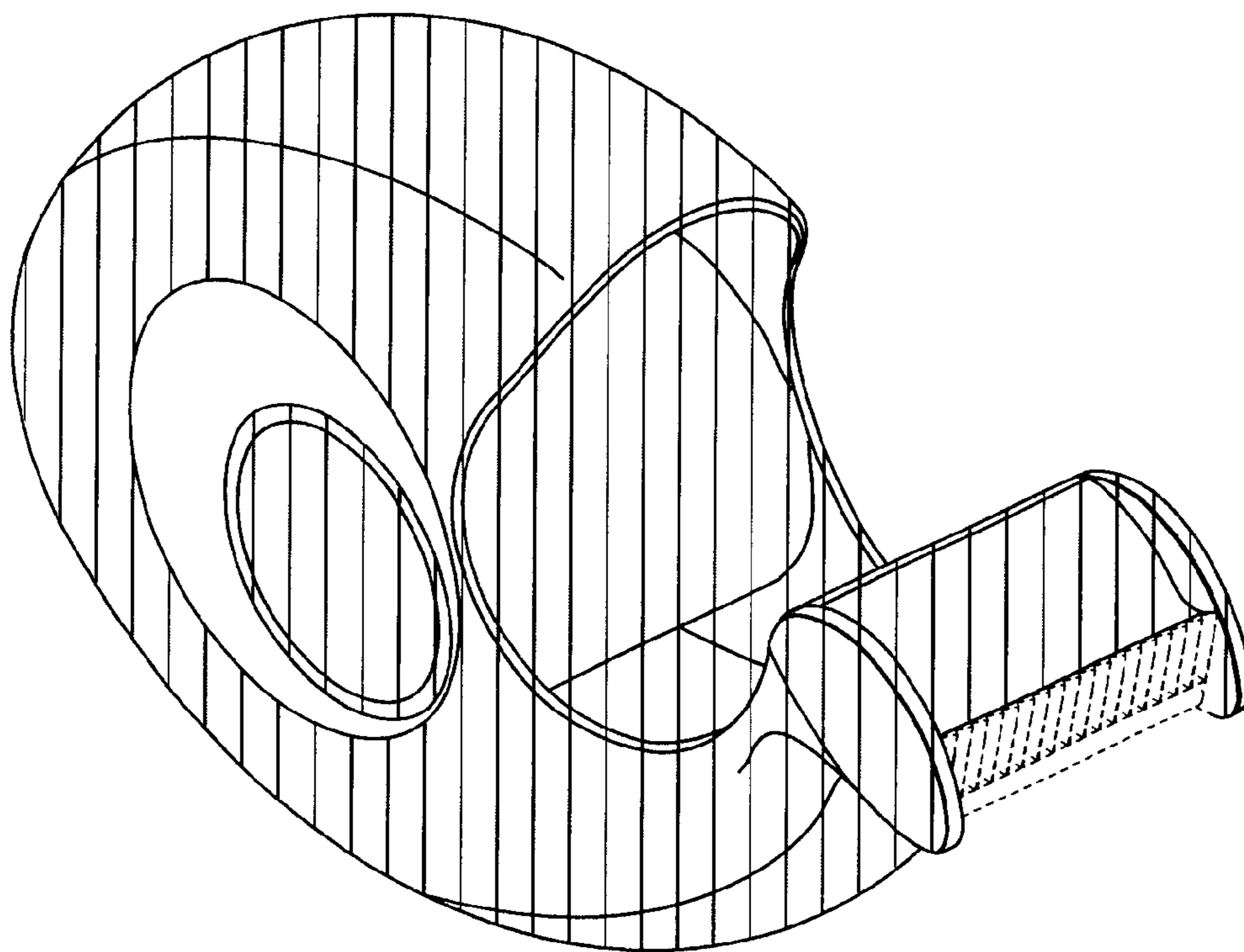

Fig. 1

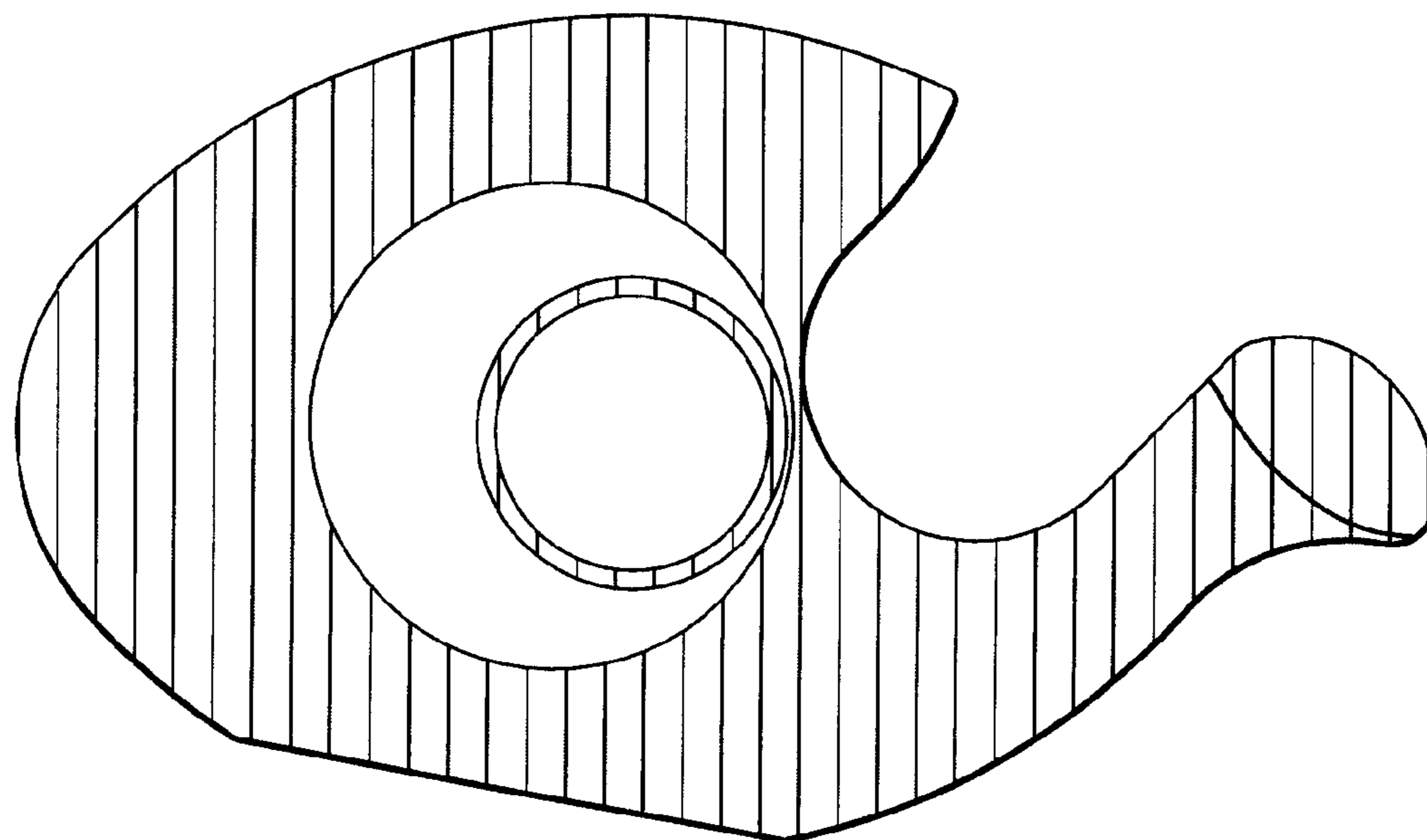

Fig. 2

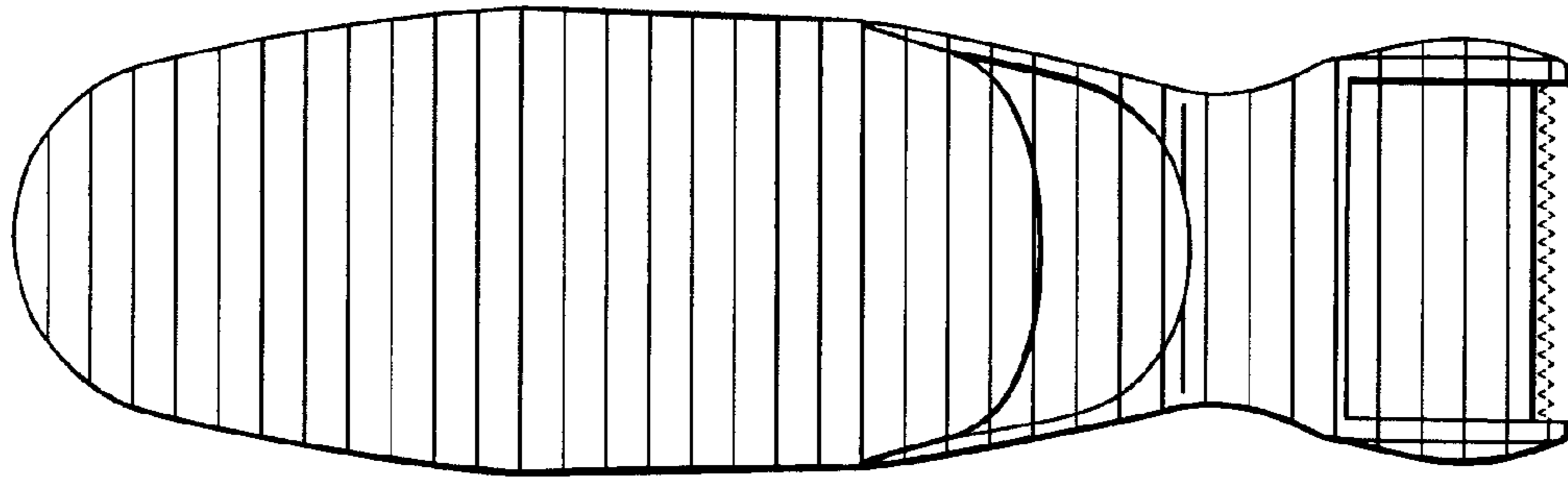

Fig. 3

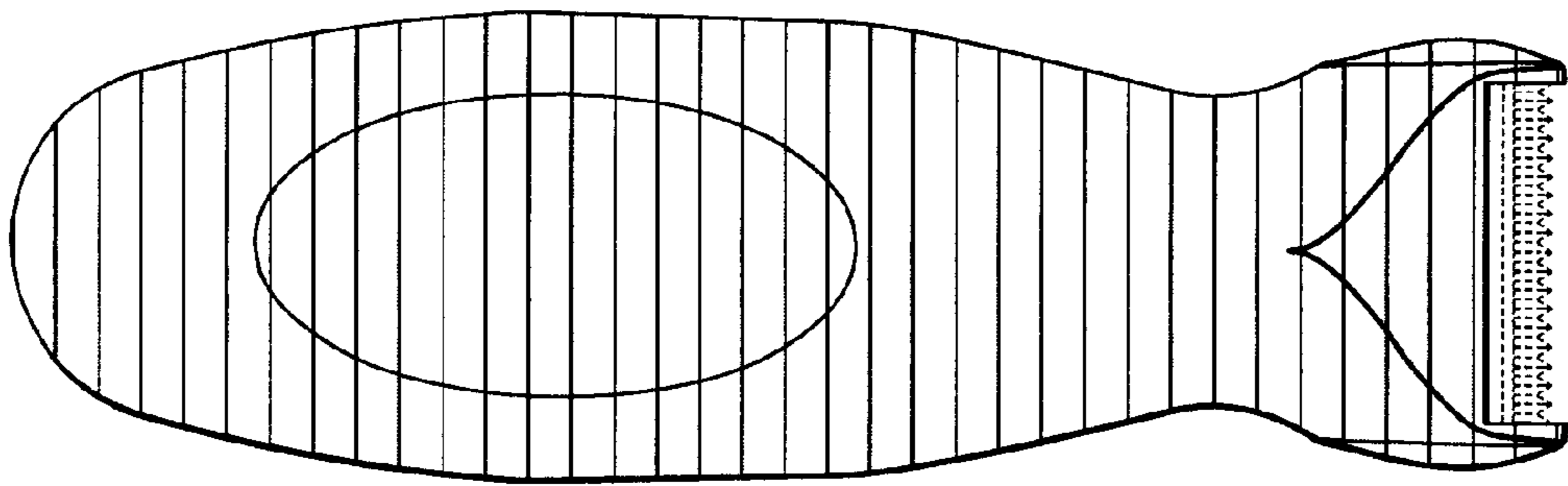

Fig. 4

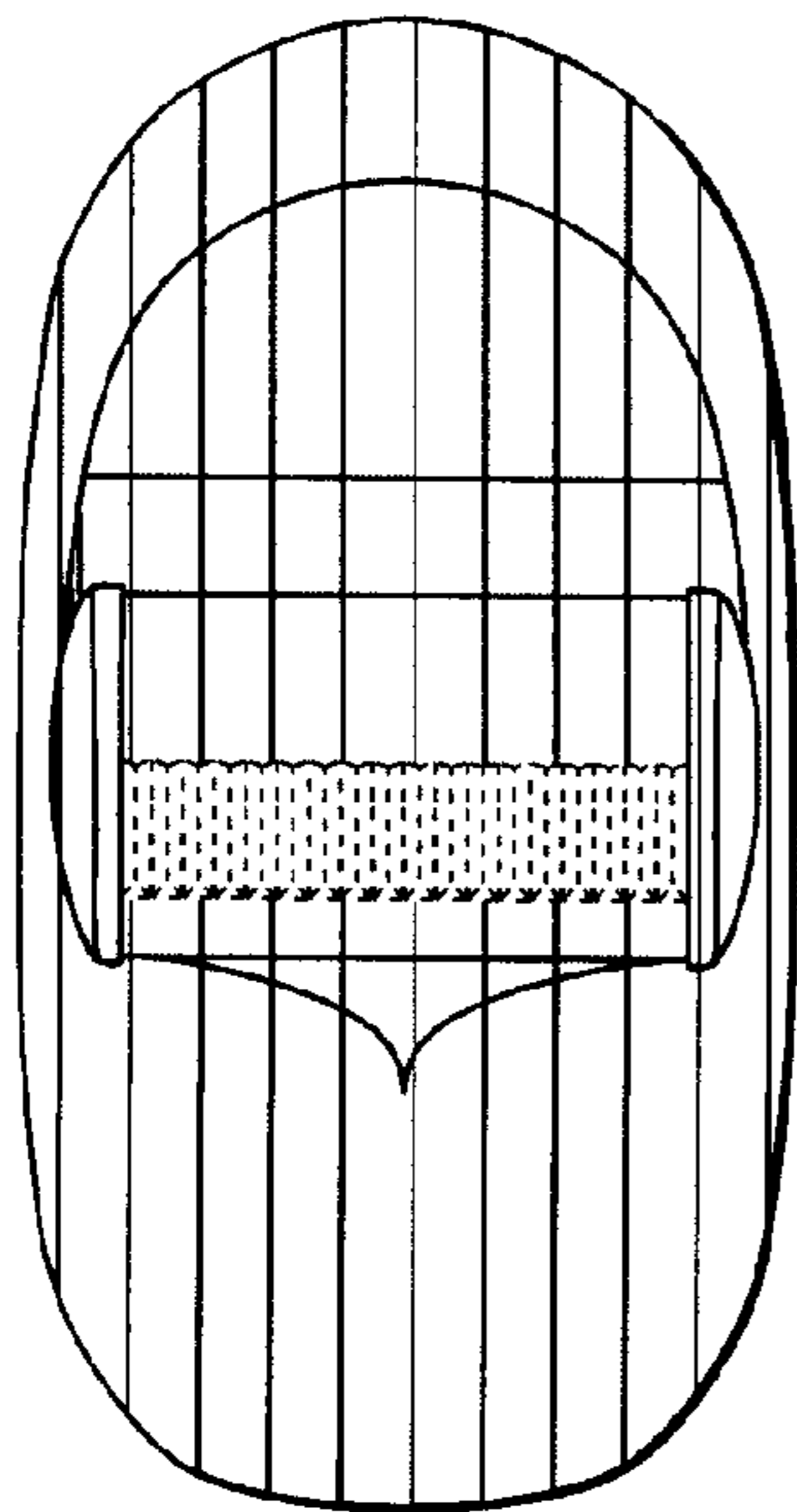

Fig. 5

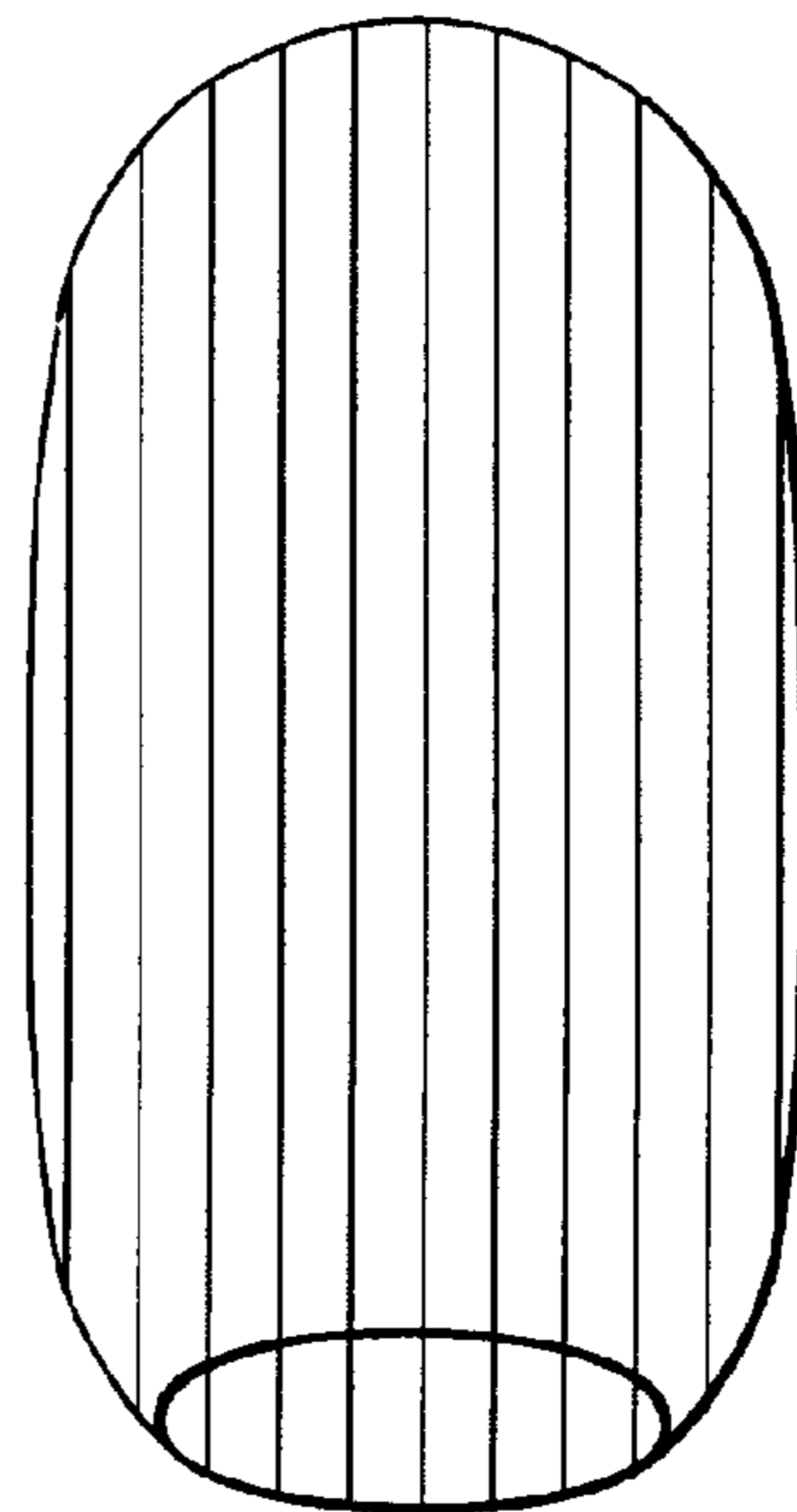

Fig. 6