

US00D523980S

(12) **United States Design Patent**
Ito et al.

(10) **Patent No.:** **US D523,980 S**
(45) **Date of Patent:** **** Jun. 27, 2006**

(54) **REAR COMBINATION LAMP OF
MOTORCYCLES**

(75) Inventors: **Masamoto Ito**, Wako (JP); **Masato
Nagata**, Wako (JP)

(73) Assignee: **Honda Motor Co. Ltd.**, Tokyo (JP)

(**) Term: **14 Years**

(21) Appl. No.: **29/230,826**

(22) Filed: **May 27, 2005**

(30) **Foreign Application Priority Data**

Nov. 29, 2004 (JP) 2004-036388

(51) **LOC (8) Cl.** **26-06**

(52) **U.S. Cl.** **D26/28**

(58) **Field of Classification Search** D26/28-36;
362/459-468, 475-478, 485-487
See application file for complete search history.

(56) **References Cited**

U.S. PATENT DOCUMENTS

D423,126 S	*	4/2000	Doss	D26/28
D462,467 S	*	9/2002	Nakazawa et al.	D26/28
D464,747 S	*	10/2002	Kokubu	D26/28
D498,012 S	*	11/2004	Ballentine	D26/28

* cited by examiner

Primary Examiner—Marcus A. Jackson
(74) *Attorney, Agent, or Firm*—Arent Fox PLLC

(57) **CLAIM**

The ornamental design for a rear combination lamp of motorcycles, as shown and described.

DESCRIPTION

FIG. 1 is a front view of a rear combination lamp for a motorcycle showing our new design.

FIG. 2 is a rear view thereof.

FIG. 3 is a plan view thereof.

FIG. 4 is a bottom view thereof.

FIG. 5 is a right side view thereof.

FIG. 6 is a left side view thereof.

FIG. 7 is a perspective view thereof as seen from the right front side.

FIG. 8 is a perspective view thereof as seen from the left front side.

FIG. 9 is a perspective view thereof as seen from the left rear side.

FIG. 10 is a perspective view thereof as seen from the right rear side; and,

FIG. 11 is a reference view thereof showing its state of use.

The broken line showing of the underneath portion is for illustrative purposes only and forms no part of the claimed design.

1 Claim, 6 Drawing Sheets

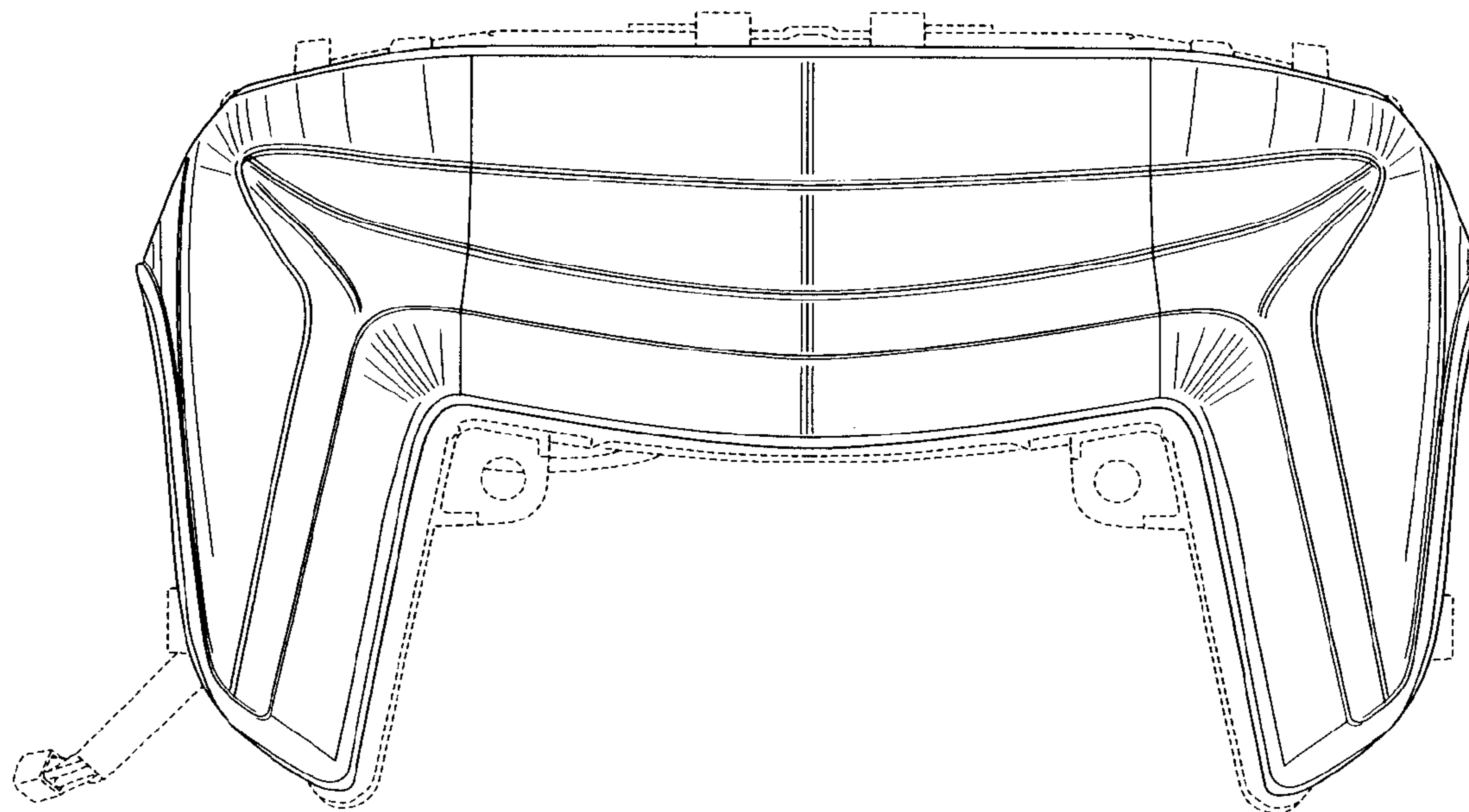

FIG.1

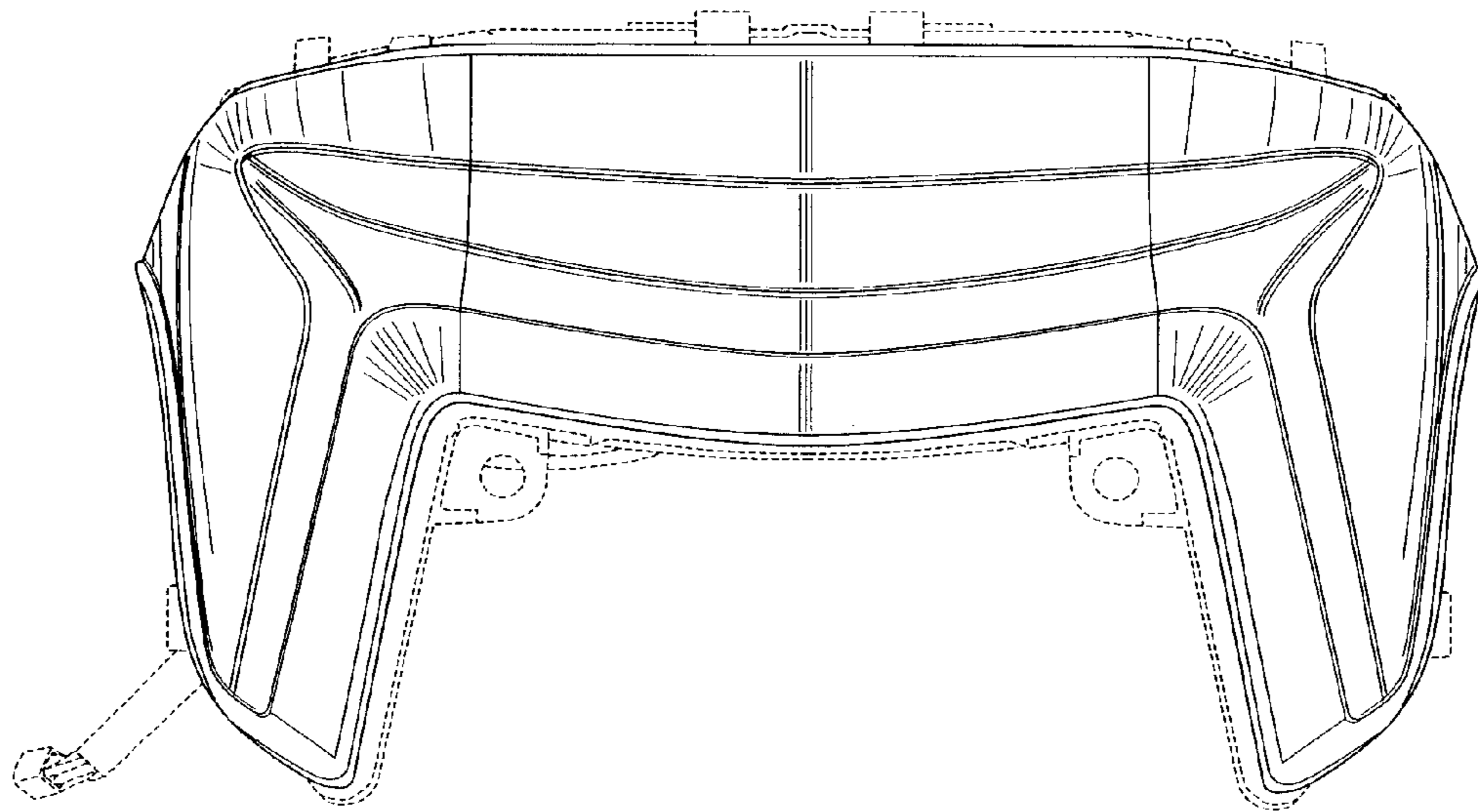

FIG.2

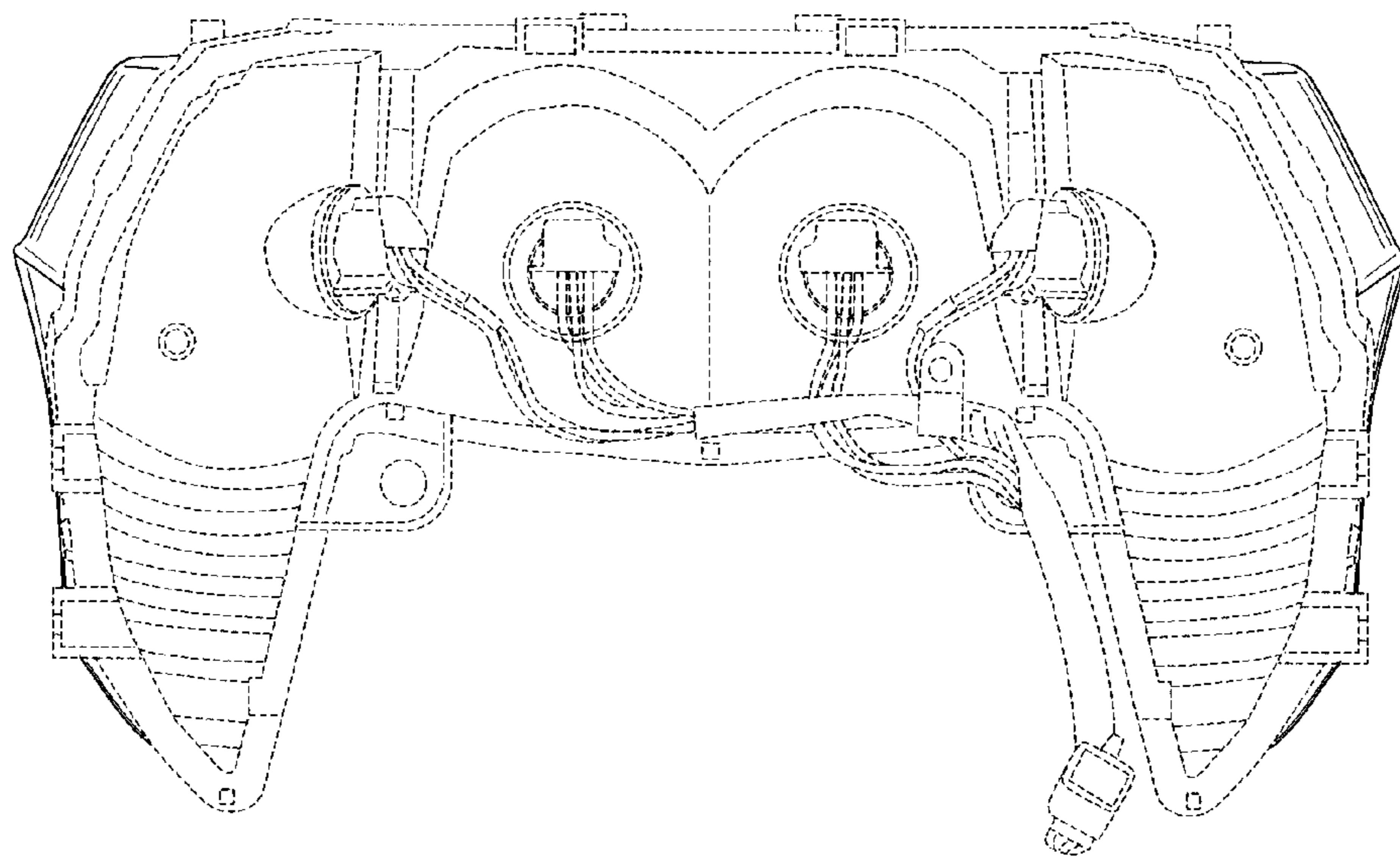

FIG.3

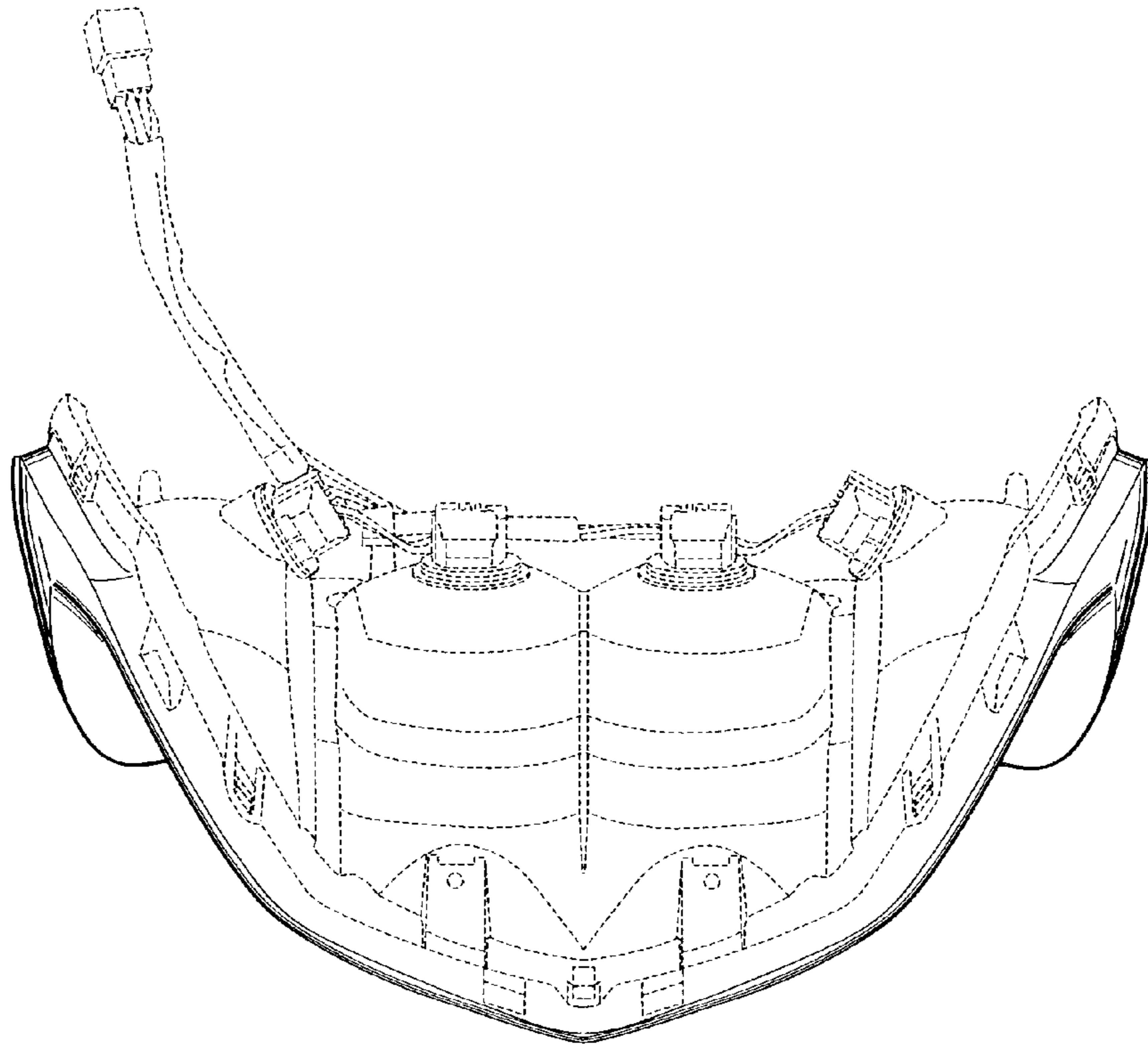

FIG.4

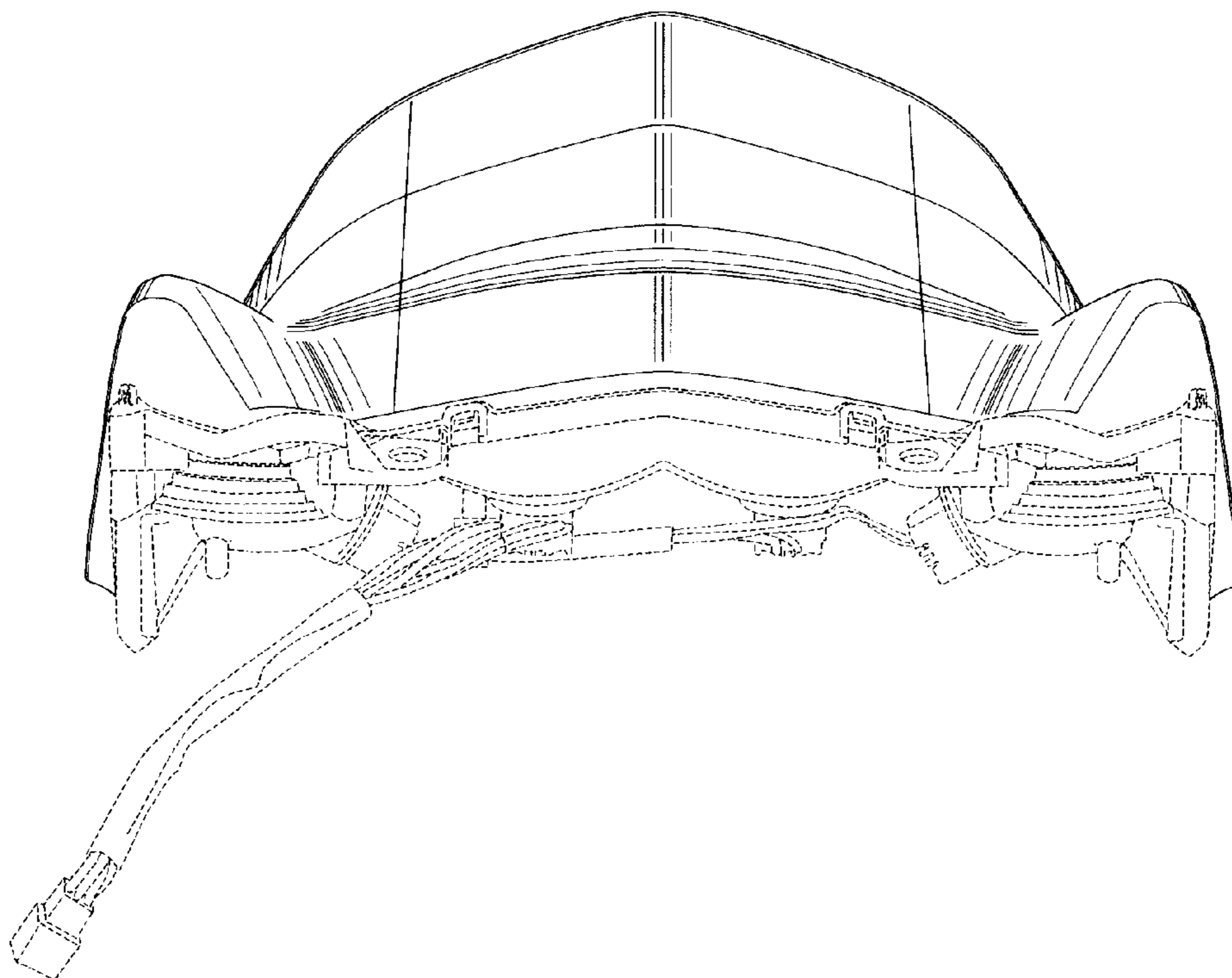

FIG.5

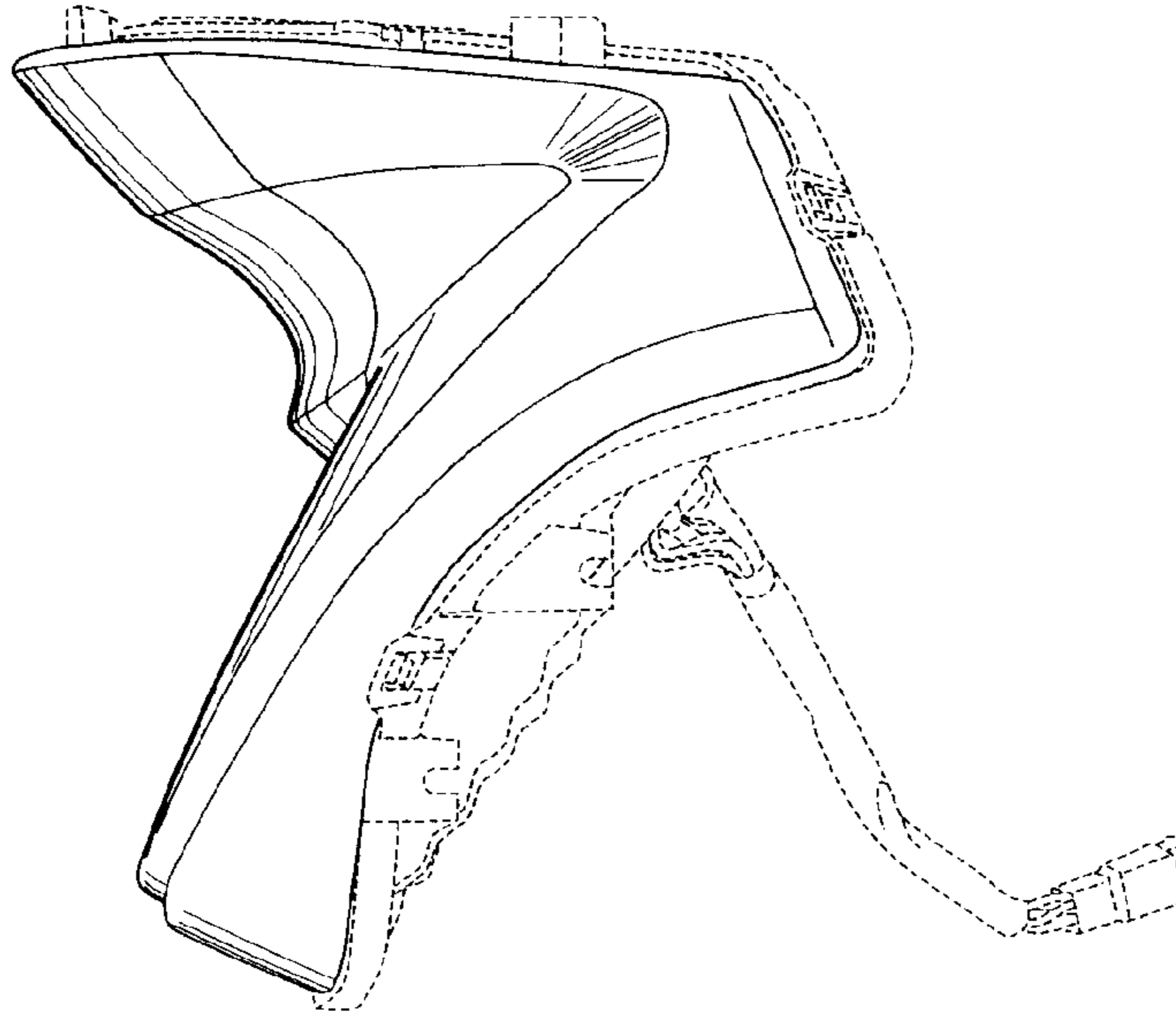

FIG.6

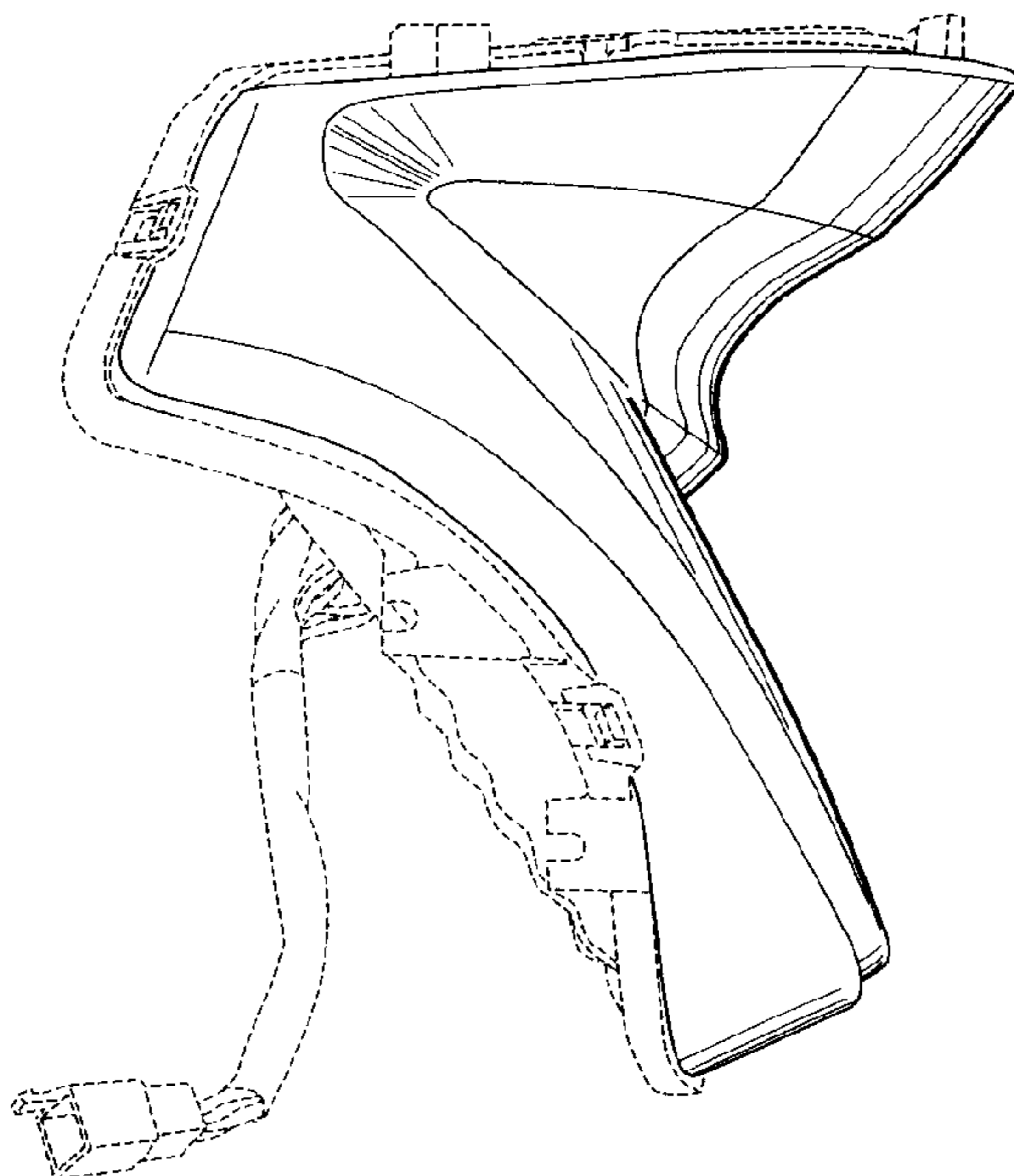

FIG.7

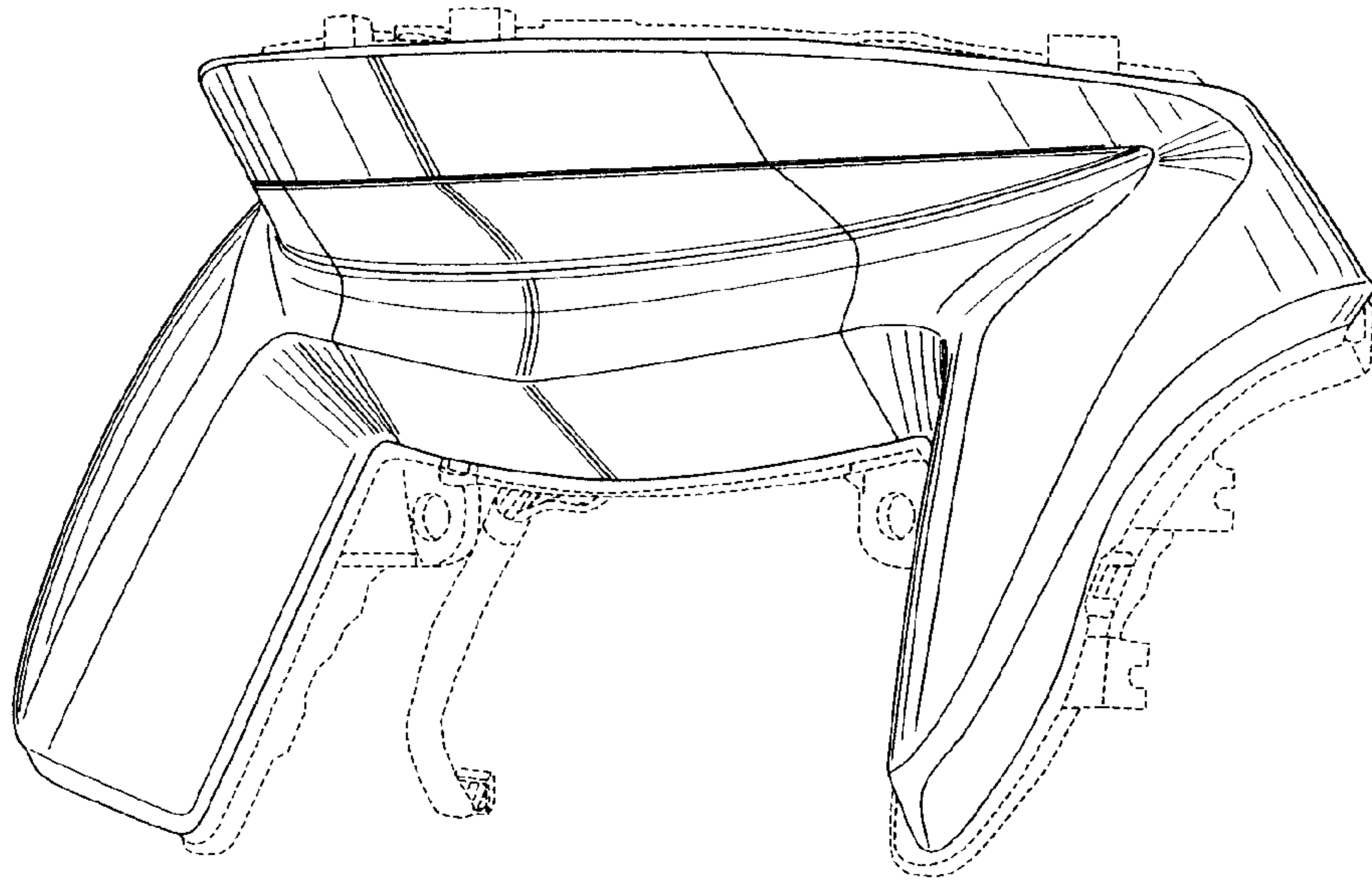

FIG.8

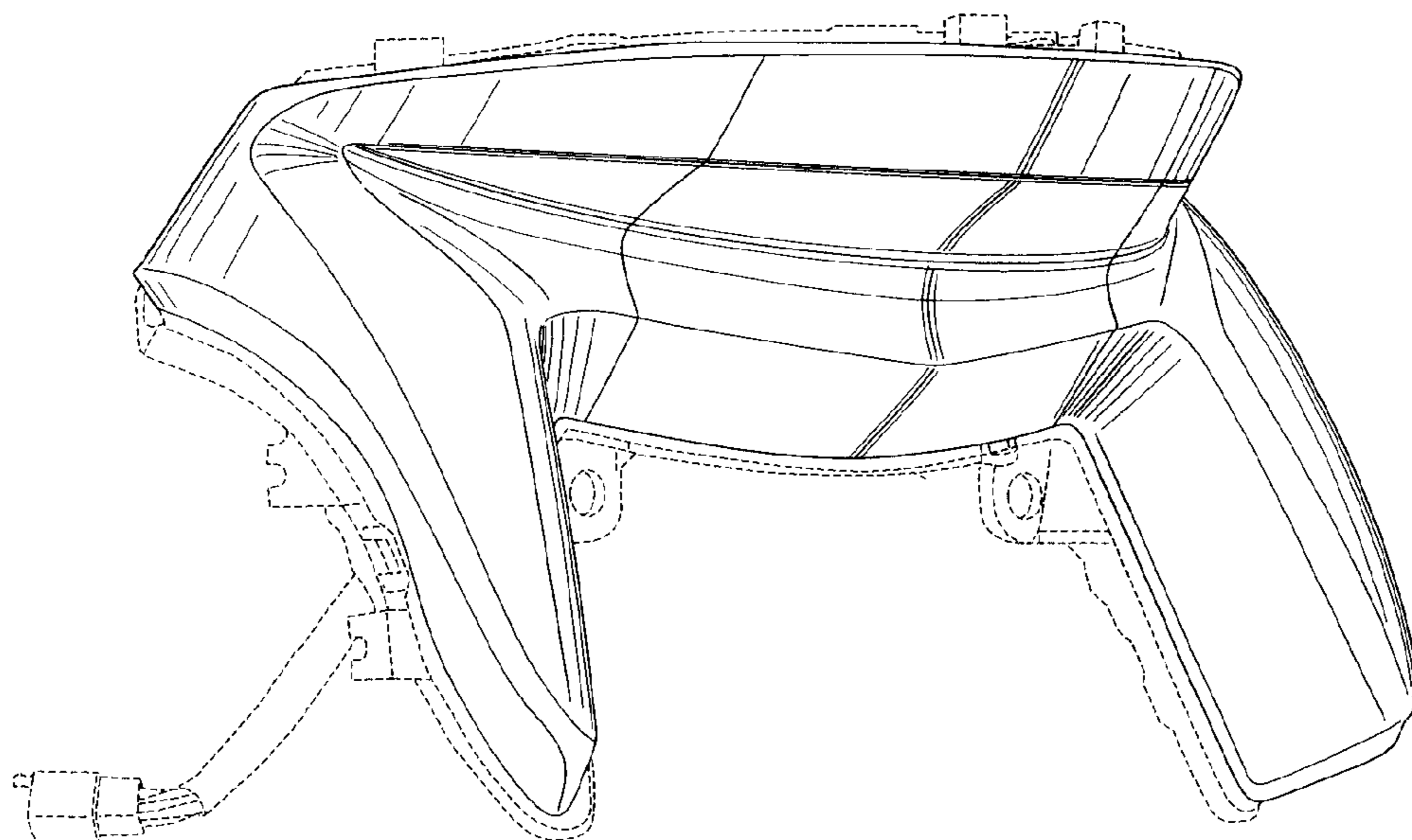

FIG.9

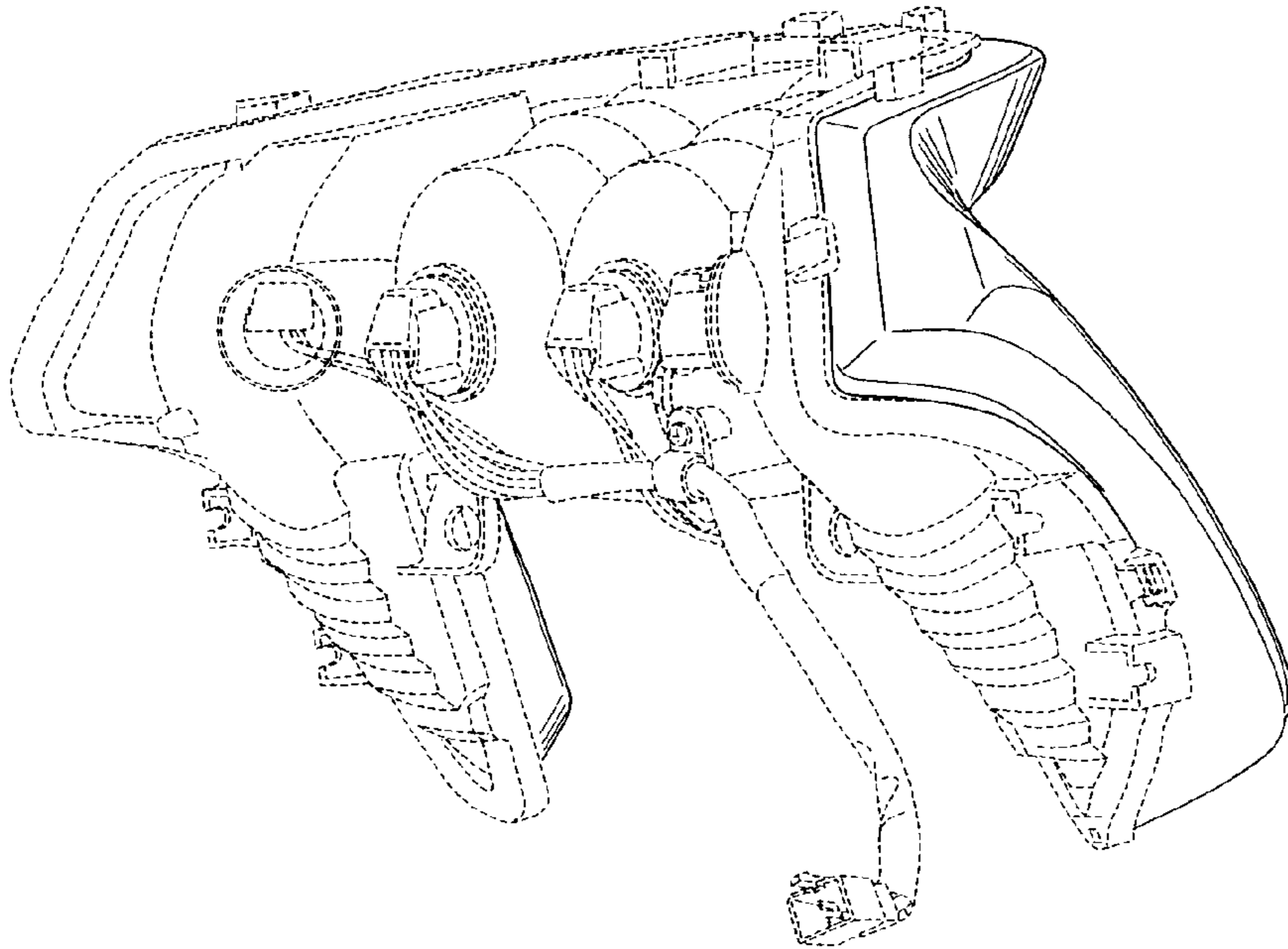

FIG.10

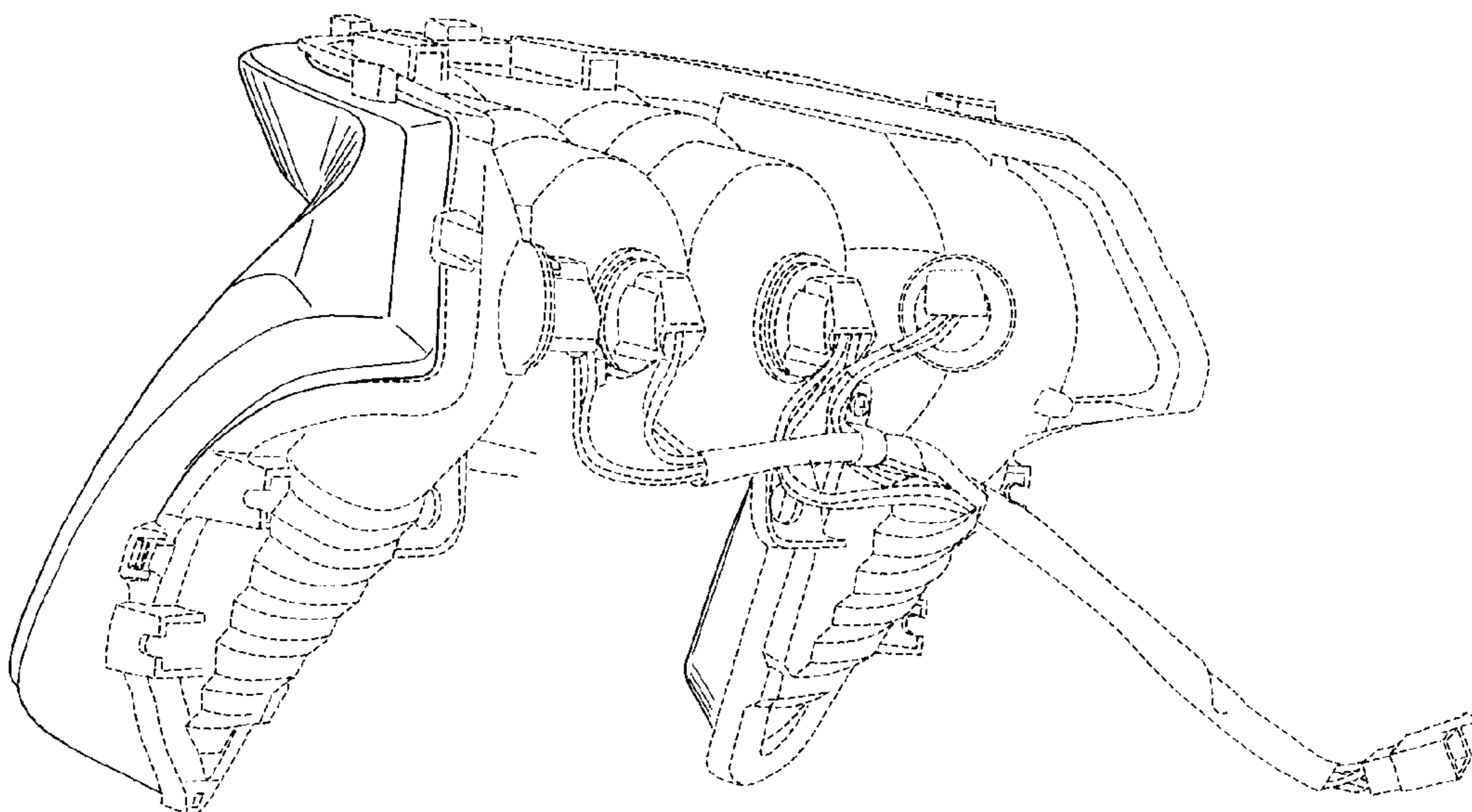

FIG.11

