



US00D523883S

(12) **United States Design Patent**
Distasio et al.

(10) **Patent No.:** **US D523,883 S**

(45) **Date of Patent:** **** Jun. 27, 2006**

(54) **CONFOCAL MICROSCOPE IMAGING HEAD**

(75) Inventors: **Christopher C. Distasio**, Rochester, NY (US); **William J. Fox**, Rochester, NY (US)

(73) Assignee: **Lucid, Inc.**, Rochester, NY (US)

(**) Term: **14 Years**

(21) Appl. No.: **29/229,836**

(22) Filed: **May 12, 2005**

(51) **LOC (8) Cl.** **16-06**

(52) **U.S. Cl.** **D16/131**

(58) **Field of Classification Search** D16/130-132, D16/219; D24/146, 158; D8/29.1, 30, 68; 356/241.1; 359/368, 383, 385, 394; 606/167, 606/177

See application file for complete search history.

(56) **References Cited**

U.S. PATENT DOCUMENTS

D243,652 S	*	3/1977	Zurwelle et al.	D8/68
D262,823 S	*	1/1982	House, II	D24/146
D316,215 S	*	4/1991	Belanger	D8/30
5,088,819 A	*	2/1992	Storz	356/241.1
D325,861 S	*	5/1992	Saito et al.	D8/68
5,207,697 A	*	5/1993	Carusillo et al.	606/167

D353,888 S	*	12/1994	Raines	D24/146
D361,078 S	*	8/1995	Atamian	D16/131
5,609,603 A	*	3/1997	Linden	606/177
5,788,639 A		8/1998	Zavislan et al.		
5,820,623 A		10/1998	Ng		
D406,737 S	*	3/1999	Farnham	D8/29.1
5,880,880 A		3/1999	Anderson et al.		
D436,118 S	*	1/2001	London et al.	D16/130
6,434,416 B1		8/2002	Mizoguchi et al.		

* cited by examiner

Primary Examiner—Paula A. Greene

(74) *Attorney, Agent, or Firm*—Kenneth J. Lukacher

(57) **CLAIM**

The ornamental design for confocal microscope imaging head, as shown and described.

DESCRIPTION

FIG. 1 is a perspective view of a confocal microscope imaging head showing my new design, the cord is drawn broken away for ease of illustration;

FIG. 2 is a left side elevation thereof;

FIG. 3 is a top view thereof;

FIG. 4 is a bottom view thereof;

FIG. 5 is a front view thereof; and,

FIG. 6 is a rear view thereof.

1 Claim, 5 Drawing Sheets

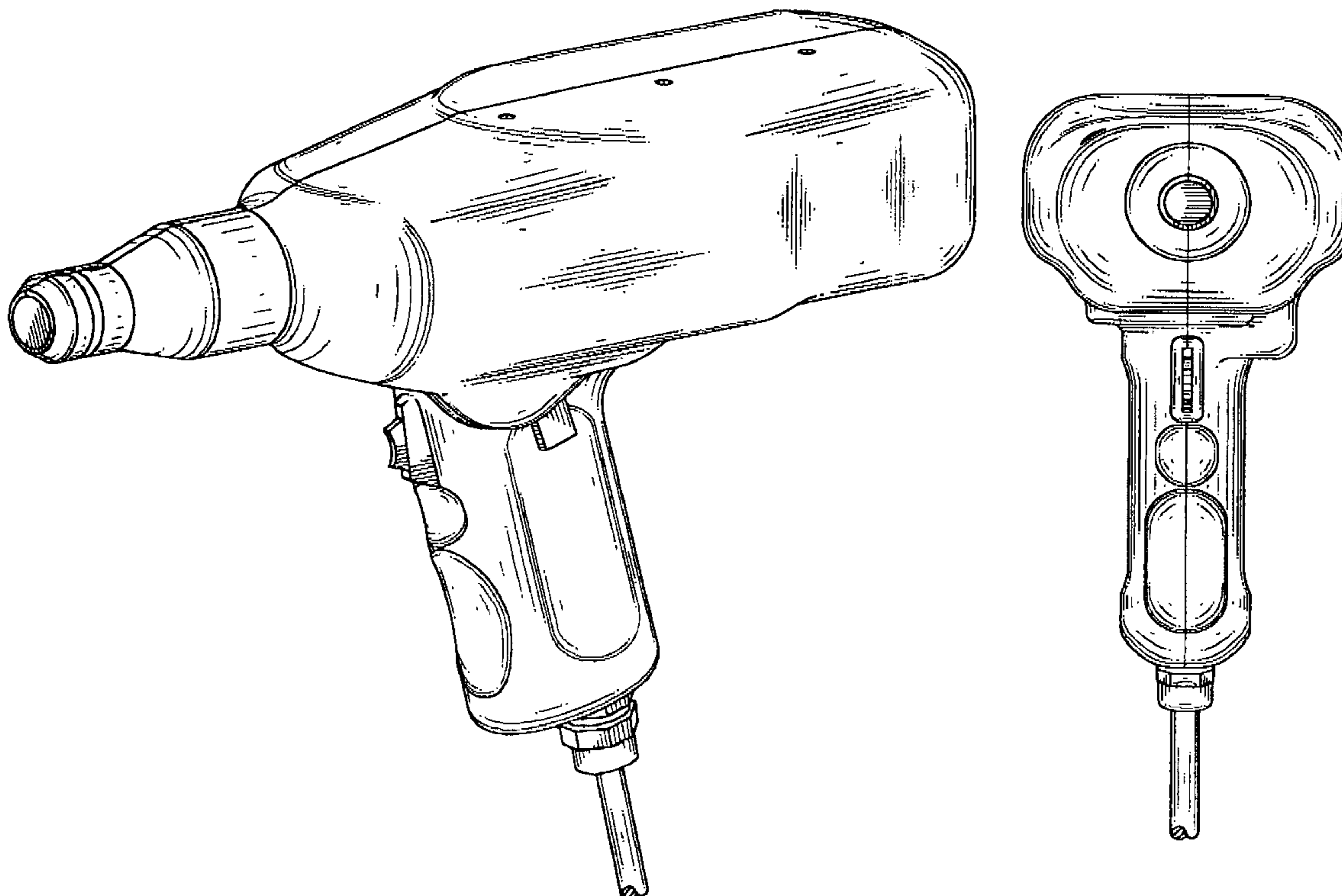

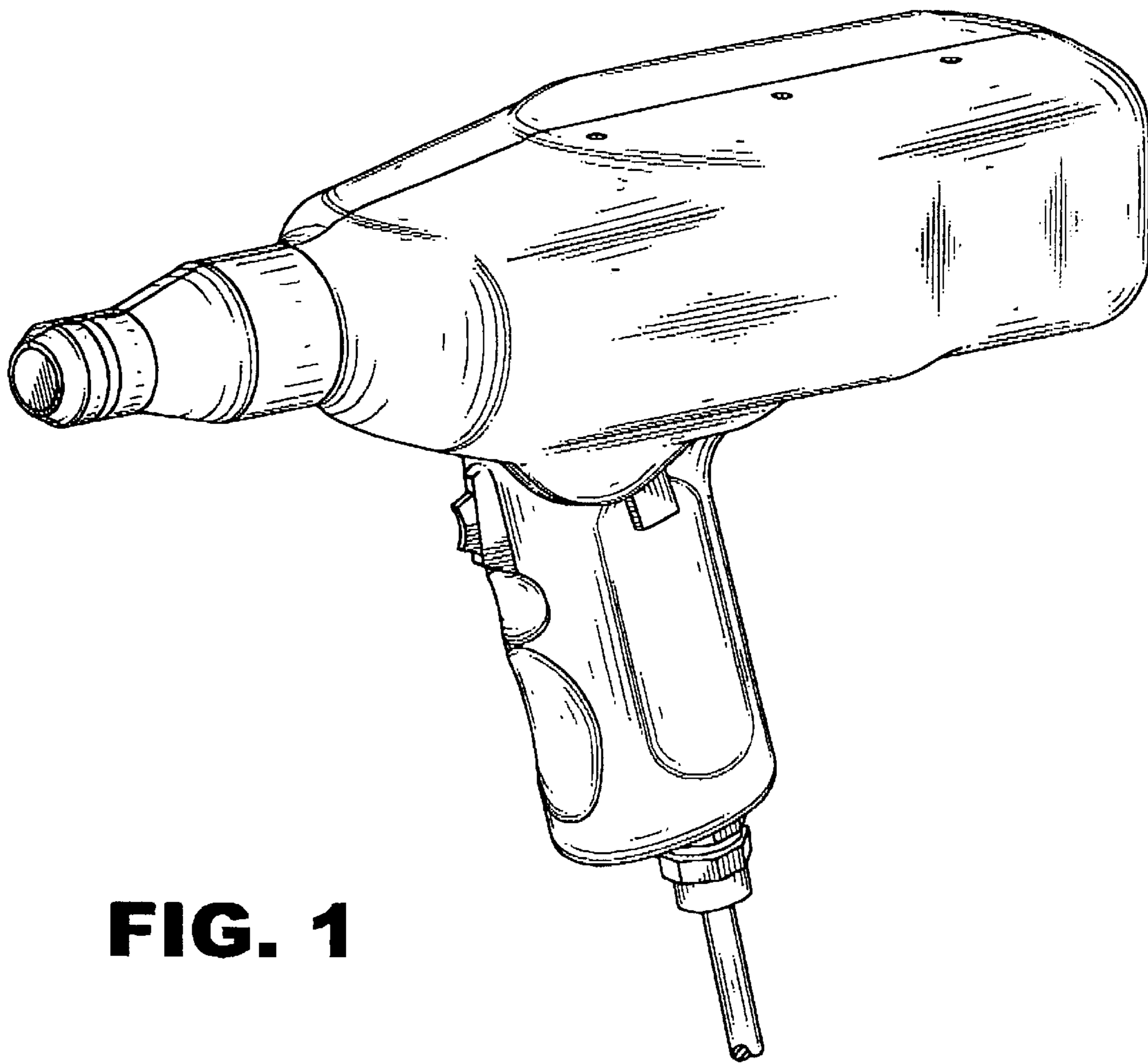

FIG. 1

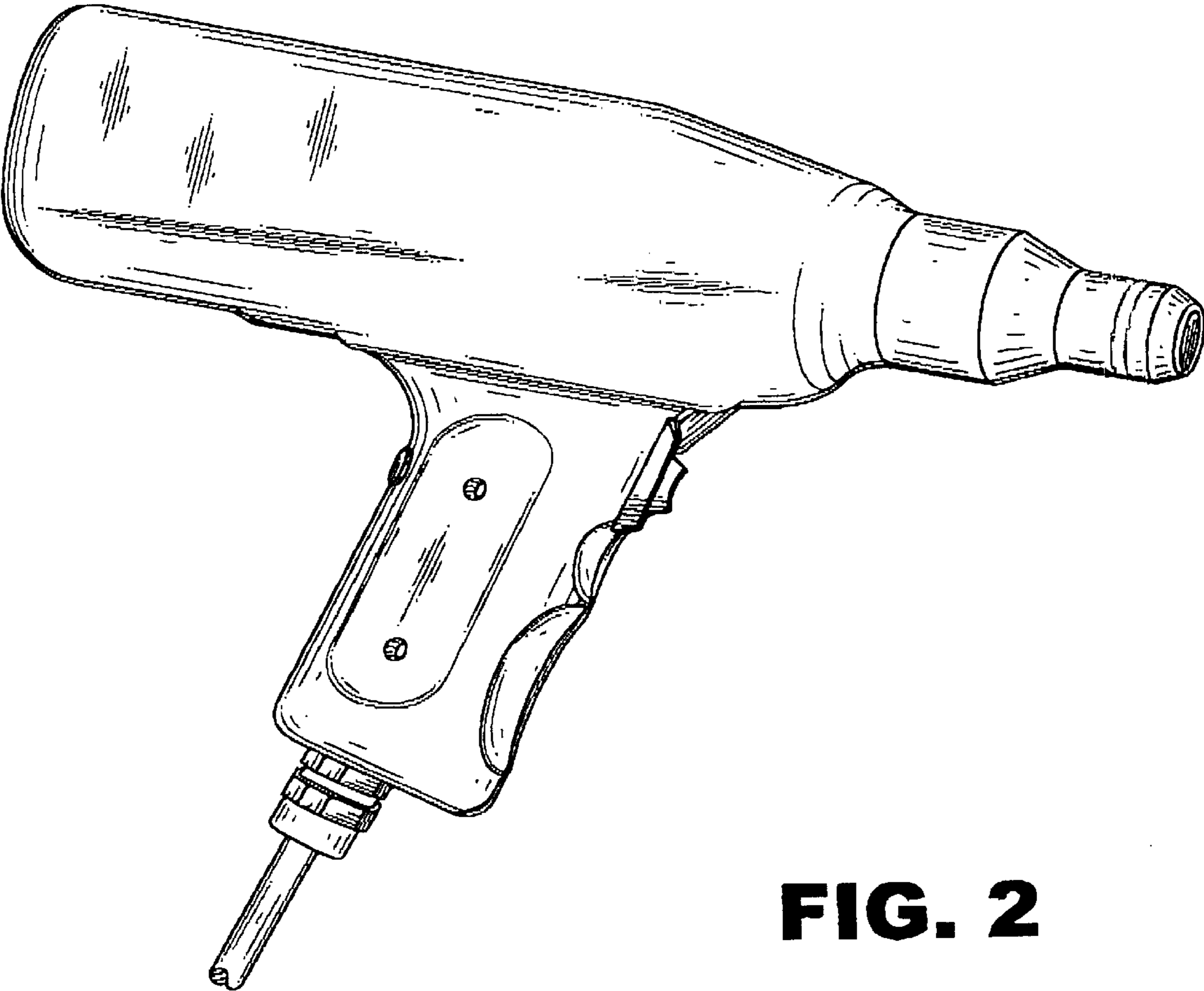

FIG. 2

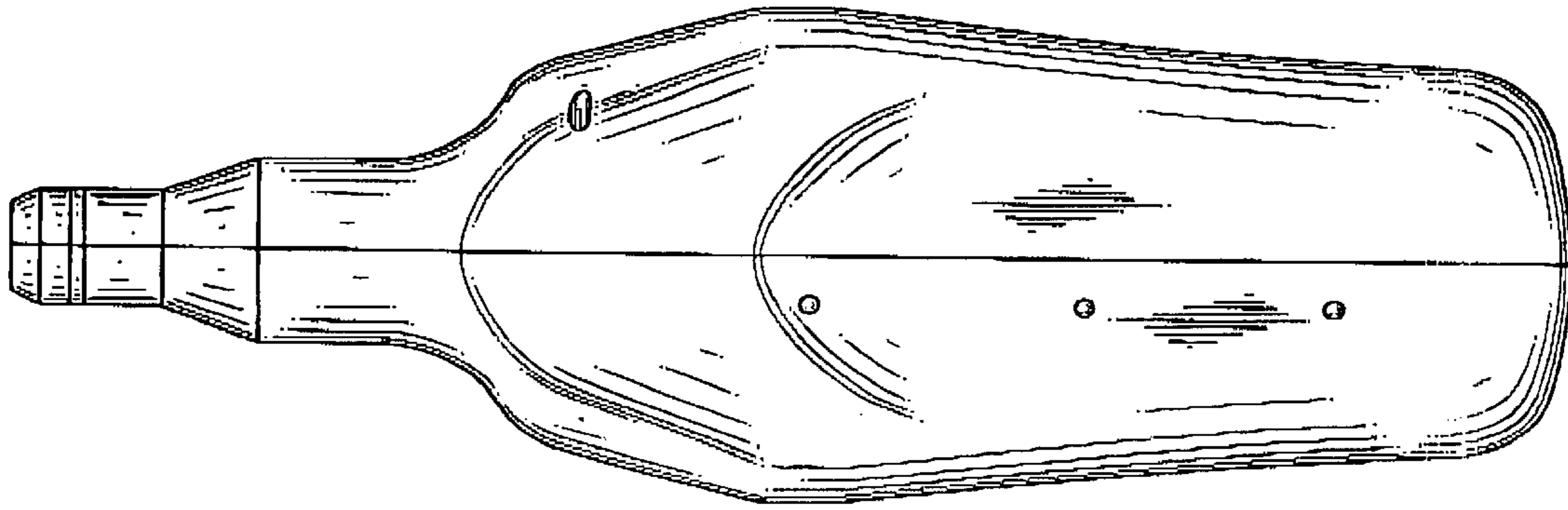

FIG. 3

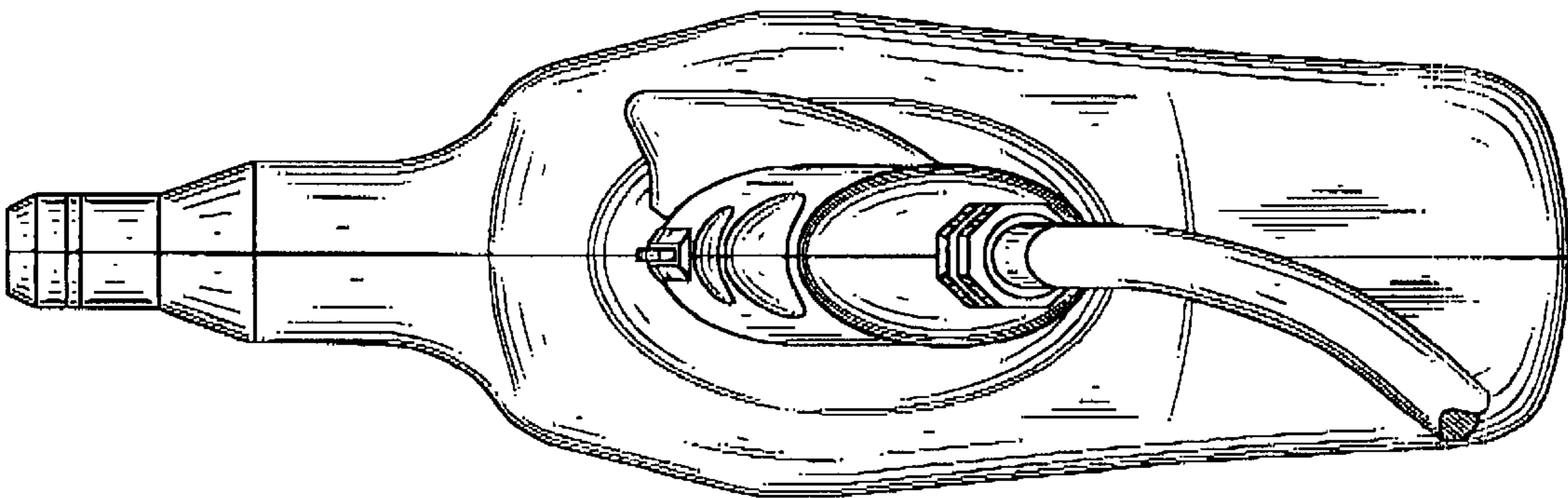

FIG. 4

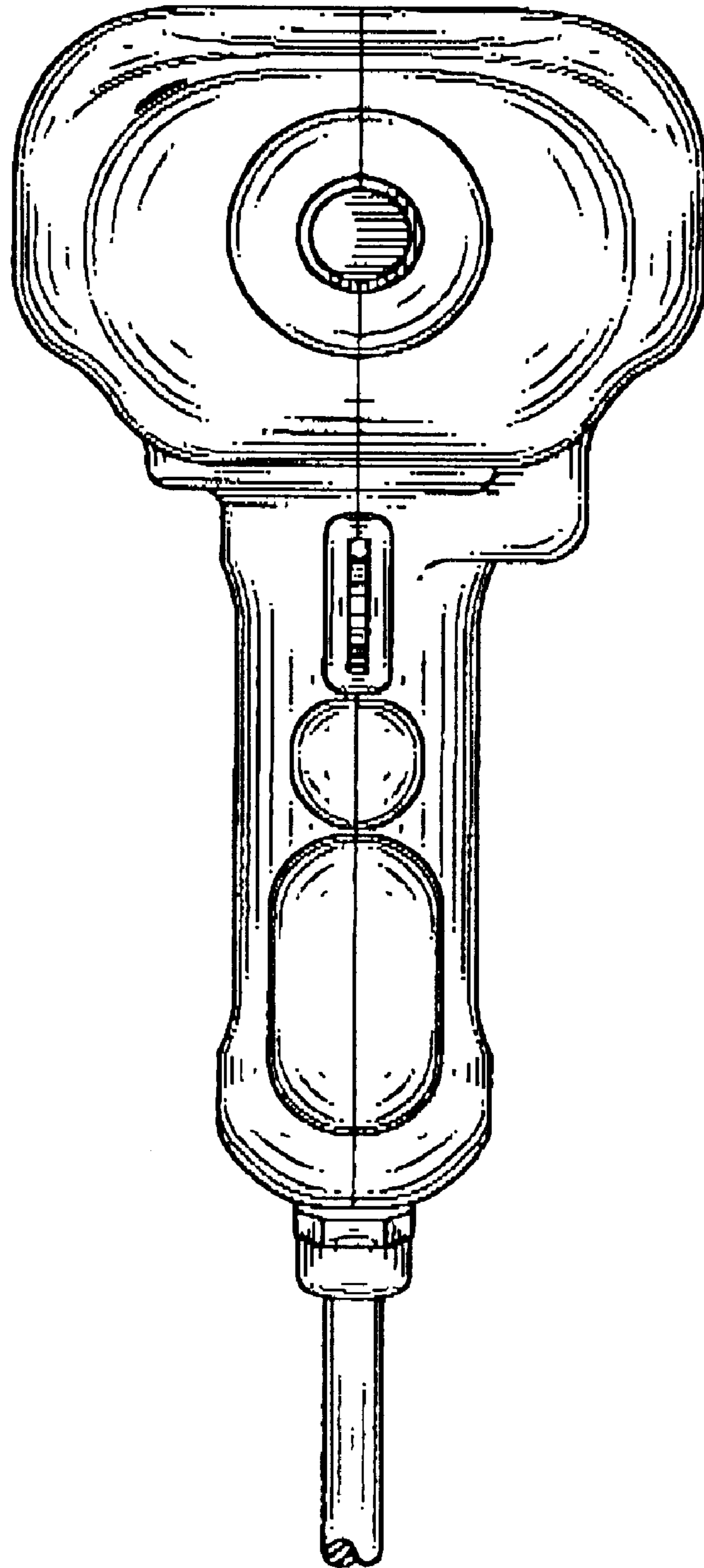

FIG. 5

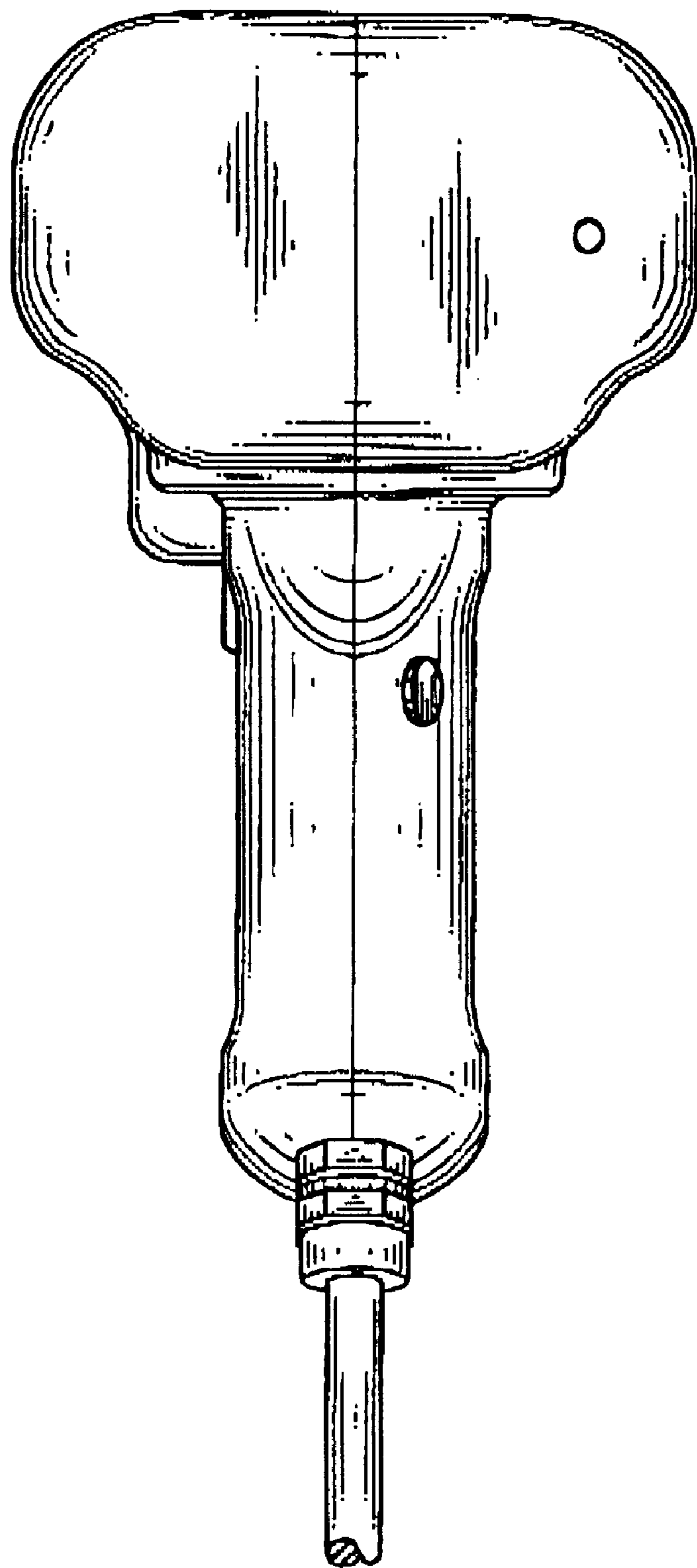

FIG. 6