



US00D523679S

(12) **United States Design Patent**  
**Illingworth**

(10) **Patent No.:** **US D523,679 S**

(45) **Date of Patent:** **\*\* Jun. 27, 2006**

(54) **ADJUSTABLE TRAVEL PILLOW**  
(75) Inventor: **Larry Illingworth**, Evans, GA (US)  
(73) Assignee: **Worth While Pillows, Inc.**, Marathon Shares, FL (US)  
(\*\*) Term: **14 Years**

5,499,418 A \* 3/1996 Tan et al. .... 5/655  
5,581,832 A 12/1996 Bridley  
D378,615 S \* 3/1997 Neviasher et al. .... D24/190  
D389,359 S \* 1/1998 Nowak ..... D6/601  
5,953,749 A \* 9/1999 Backs ..... 2/1  
6,158,813 A \* 12/2000 Karash ..... 297/391  
D465,785 S \* 11/2002 Goto ..... D14/447  
D494,128 S 8/2004 Berger  
6,804,845 B1 \* 10/2004 Stewart et al. .... 5/632

(21) Appl. No.: **29/221,018**

\* cited by examiner

(22) Filed: **Jan. 10, 2005**

*Primary Examiner*—Robert M. Spear  
*Assistant Examiner*—Mary Ann Calabrese

(51) **LOC (8) Cl.** ..... **06-09**

(74) *Attorney, Agent, or Firm*—J. Bennett Mullinax, LLC

(52) **U.S. Cl.** ..... **D6/601**

(58) **Field of Classification Search** ..... D6/595,  
D6/596, 601, 604; 5/617, 621, 622, 632,  
5/636, 637, 639, 652, 655, 655.01, 657, 922;  
D14/447; D12/400; 297/391, 232, 452.16;  
248/118, 118.5

See application file for complete search history.

(57) **CLAIM**

The ornamental design for an adjustable travel pillow, as shown and described.

**DESCRIPTION**

FIG. 1 is a perspective view of an adjustable travel pillow. FIG. 2 is a front plan view of the adjustable travel pillow. FIG. 3 is a top plan view of the adjustable travel pillow. FIG. 4 is a rear plan view of the adjustable travel pillow. FIG. 5 is a bottom plan view of the adjustable travel pillow. FIG. 6 is a left end view of the adjustable travel pillow. FIG. 7 is a right end view of the adjustable travel pillow. FIG. 8 is a perspective view of the adjustable travel pillow showing an alternative placement of a pillow support member along a panel of the adjustable travel pillow; and, FIG. 9 is an upper perspective view of the adjustable travel pillow in a folded configuration.

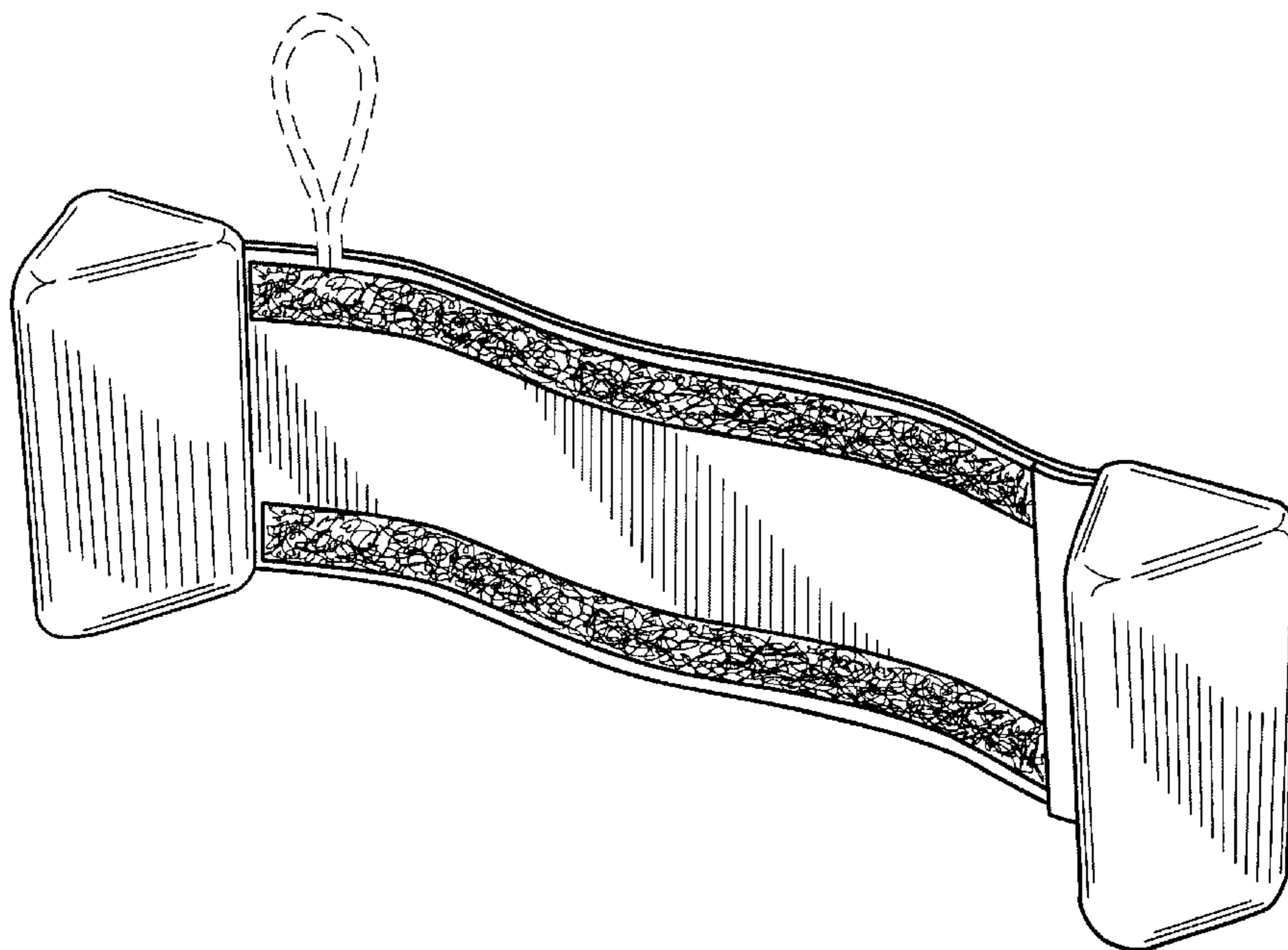
The broken lines showing a loop handle in FIGS. 1 through 9 are for illustrative purposes only and form no part of the claimed design.

(56) **References Cited**

**U.S. PATENT DOCUMENTS**

2,582,571 A 1/1952 Thoma  
2,952,856 A 9/1960 Ruff  
4,274,673 A 6/1981 Kifferstein  
4,506,396 A 3/1985 Ritchie, Jr. et al.  
4,528,981 A 7/1985 Behar  
4,571,757 A 2/1986 Zolecki  
4,964,418 A 10/1990 Wilson  
5,147,110 A 9/1992 Syers  
5,193,238 A \* 3/1993 Clute ..... 5/655  
5,216,772 A \* 6/1993 Clute ..... 5/655  
5,272,780 A \* 12/1993 Clute ..... 5/655  
5,310,245 A 5/1994 Lyszczasz  
5,345,633 A 9/1994 Harnish  
5,347,669 A \* 9/1994 Neviasher et al. .... 5/655

**1 Claim, 3 Drawing Sheets**



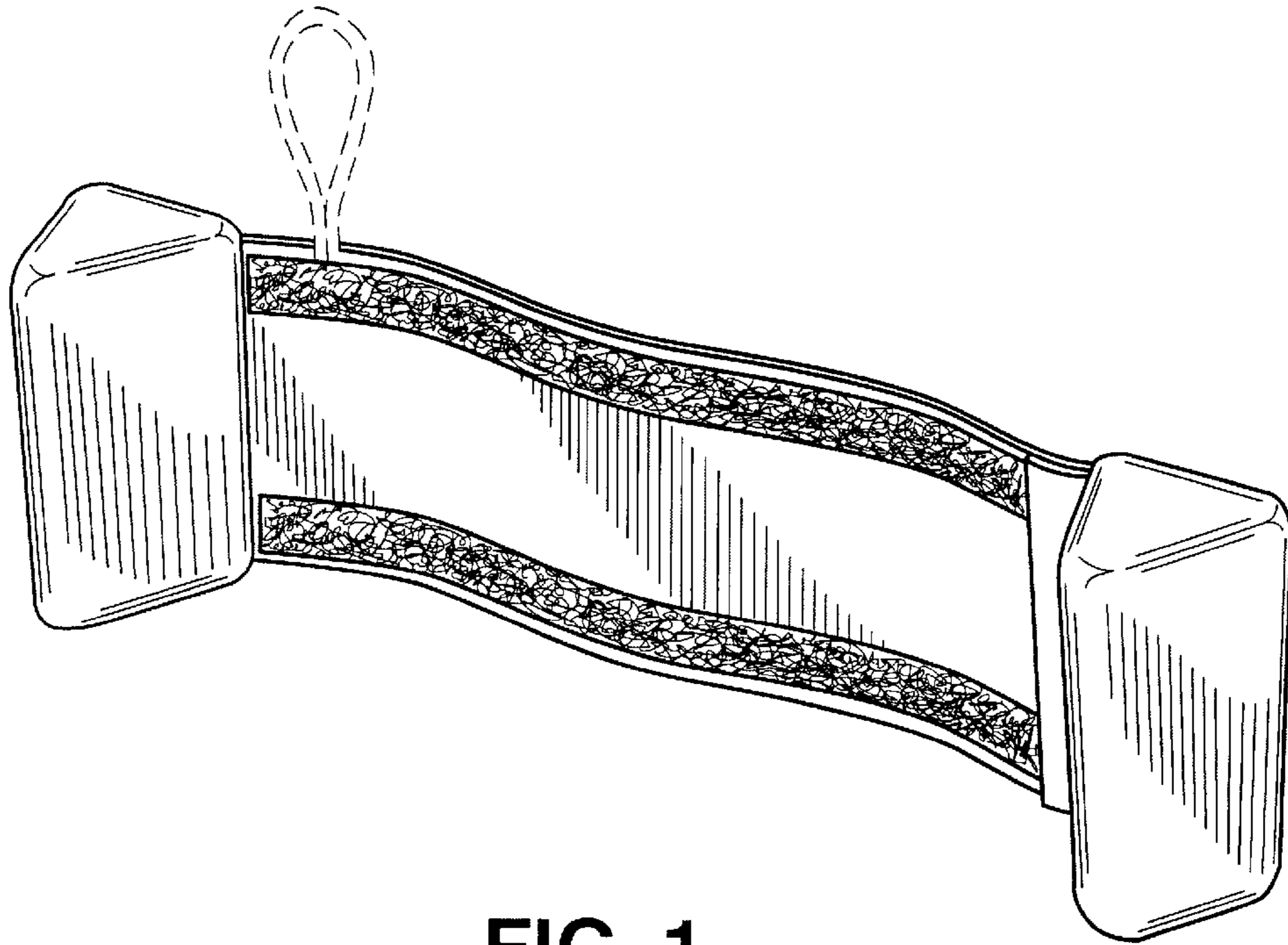


FIG. 1

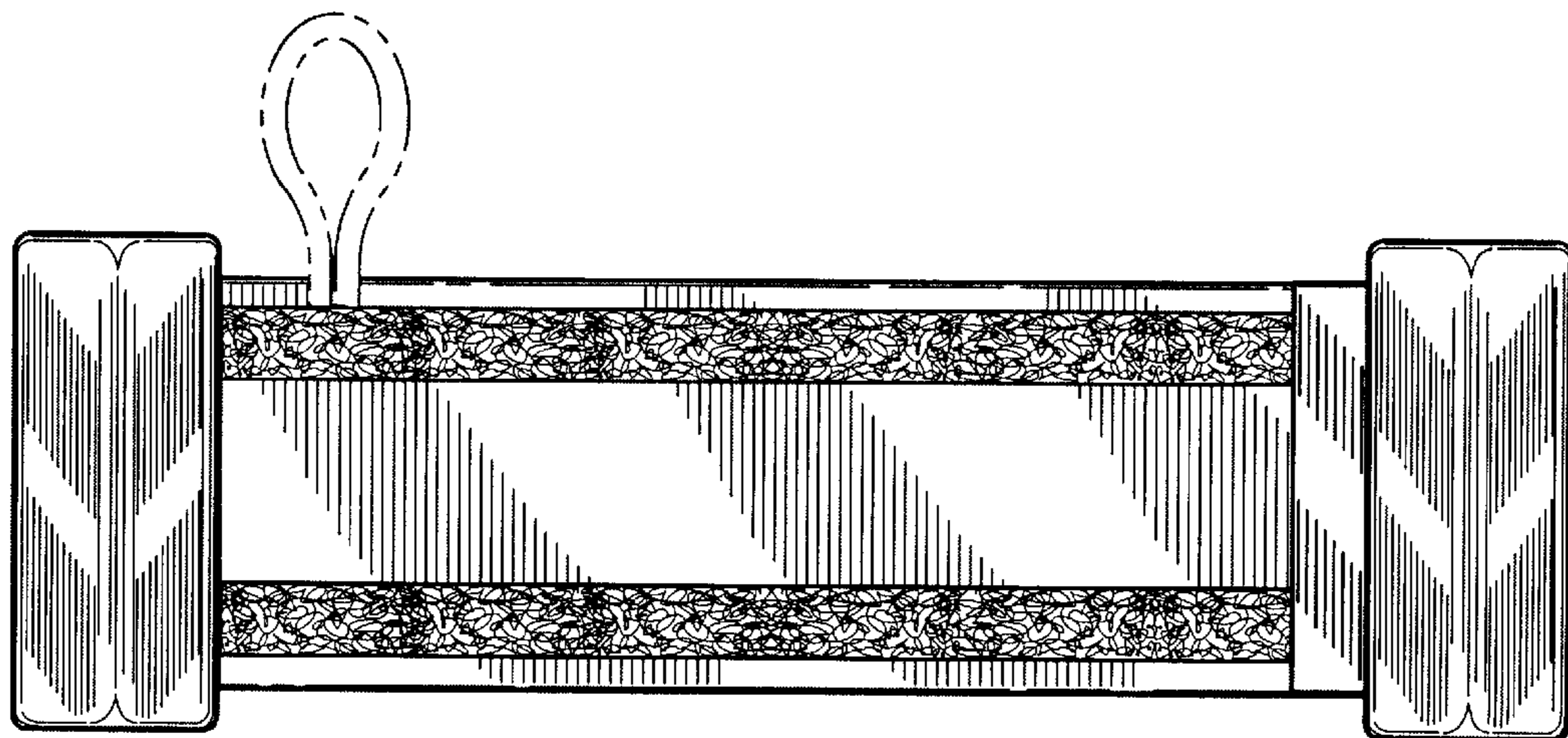
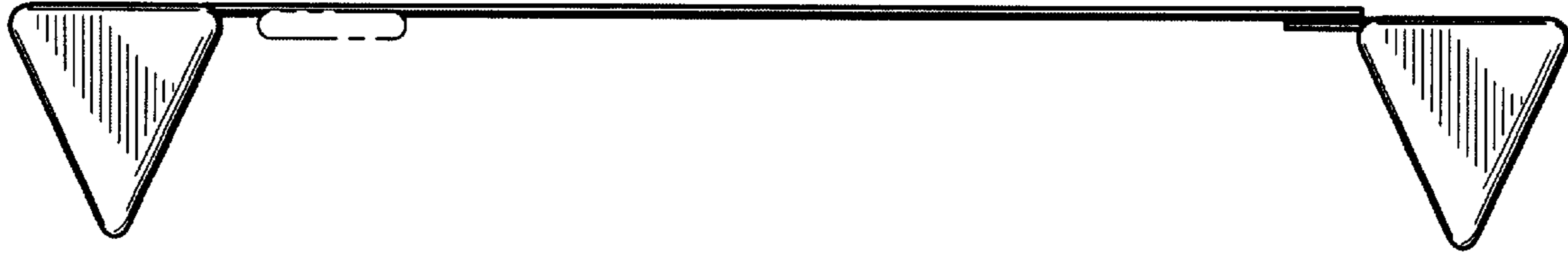
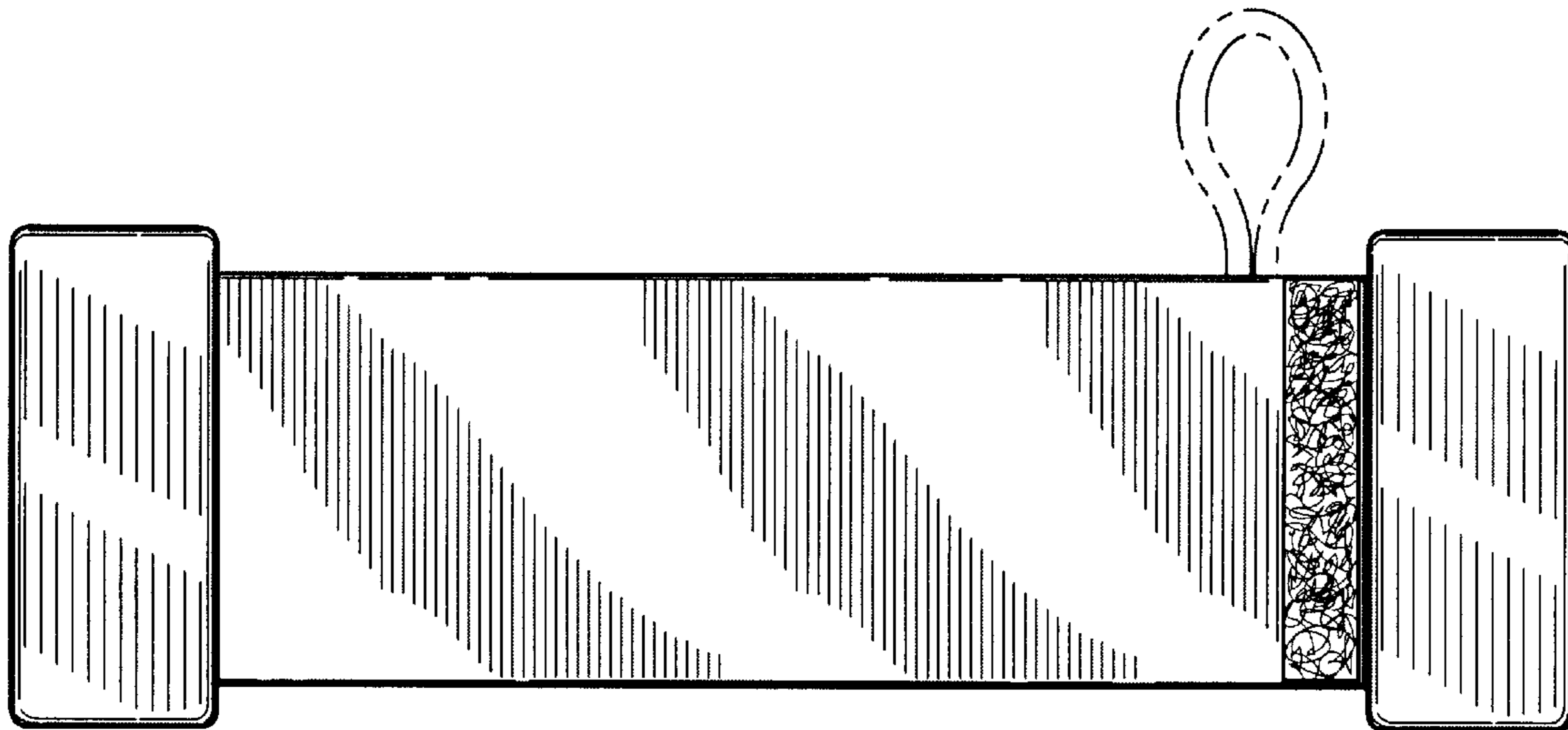


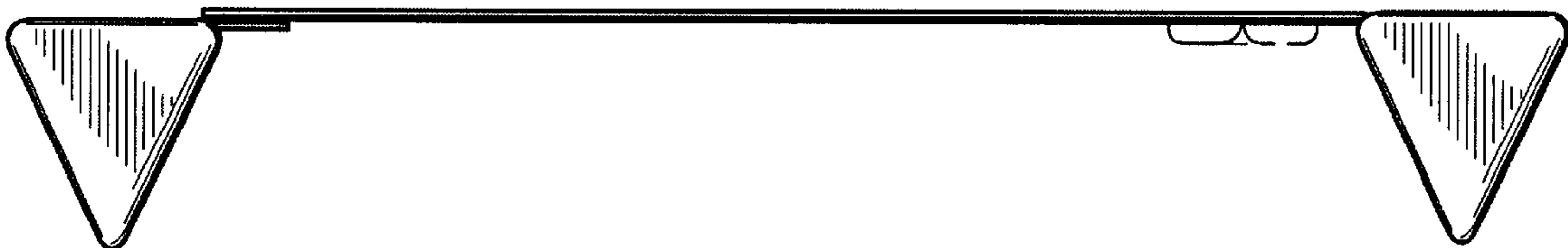
FIG. 2



**FIG. 3**

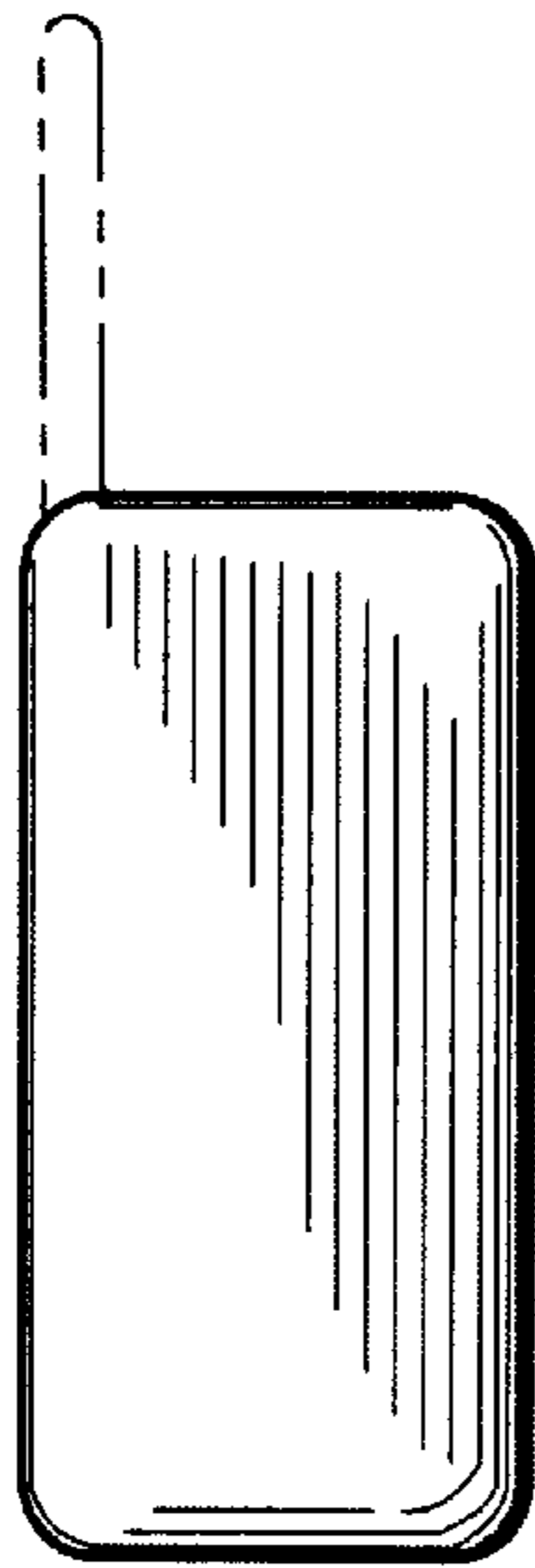


**FIG. 4**

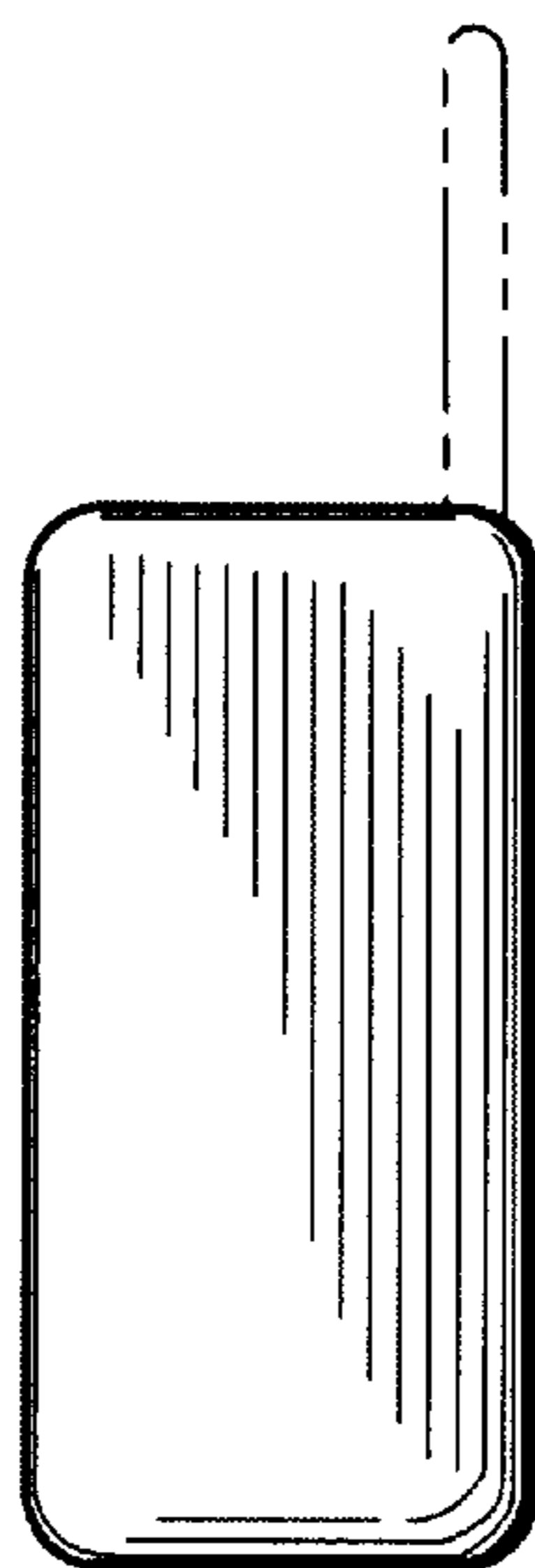


**FIG. 5**

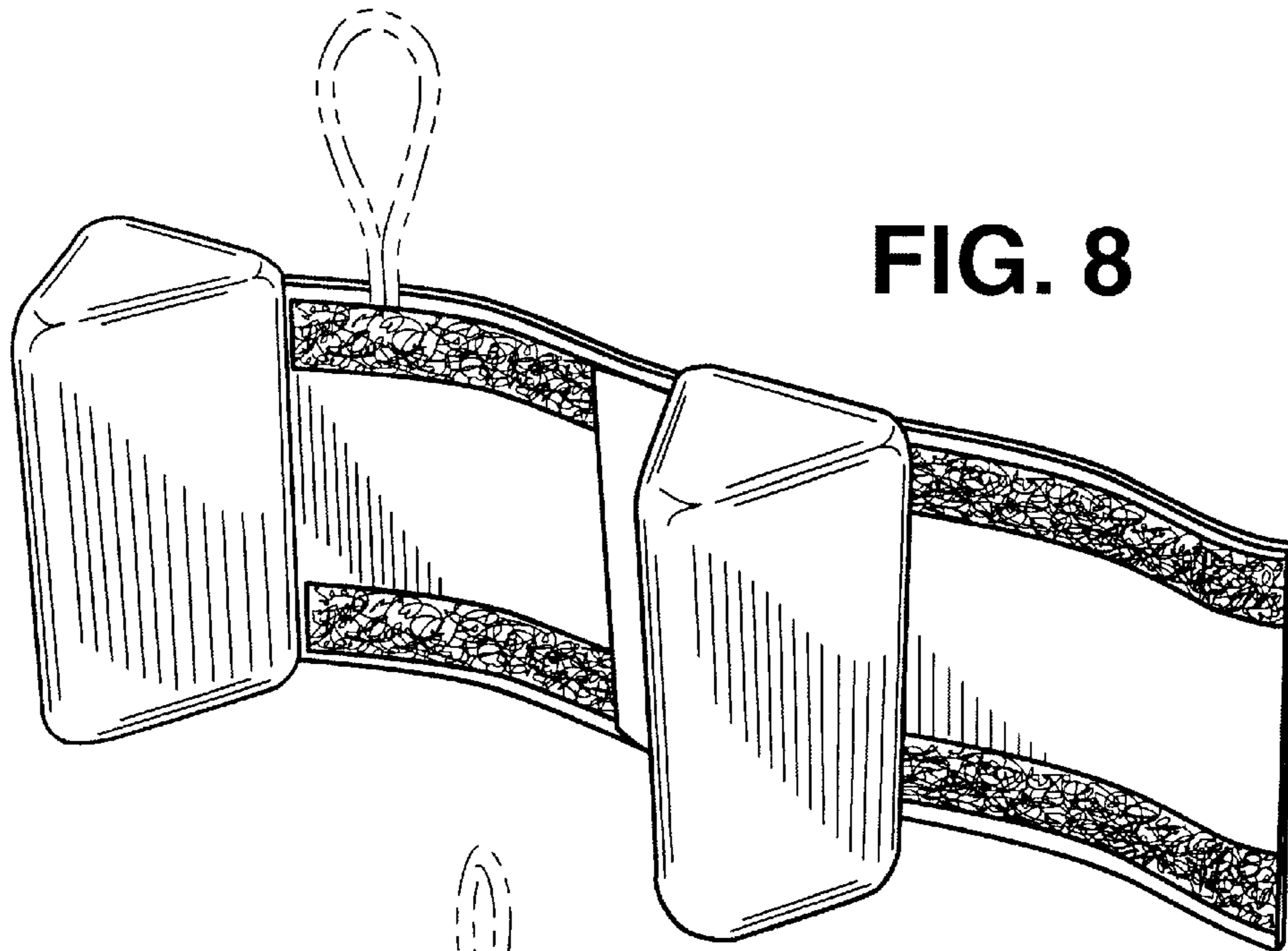
**FIG. 6**



**FIG. 7**



**FIG. 8**



**FIG. 9**

