



US00D523659S

(12) **United States Design Patent**
Prillaman et al.

(10) **Patent No.:** **US D523,659 S**

(45) **Date of Patent:** **** Jun. 27, 2006**

(54) **BED**

(75) Inventors: **Glenn Prillaman**, Greensboro, NC
(US); **Rick Shroeder**, Jamestown, NC
(US); **Mike Warren**, Grand Rapids, MI
(US)

(73) Assignee: **Stanley Furniture, Inc.**, Stanleytown,
VA (US)

(**) Term: **14 Years**

(21) Appl. No.: **29/213,089**

(22) Filed: **Sep. 13, 2004**

(51) **LOC (8) Cl.** **06-01**

(52) **U.S. Cl.** **D6/395**

(58) **Field of Classification Search** D6/382,
D6/385, 388-395, 505-508; 5/53.1, 907,
5/279.1, 280, 281, 2.1, 308

See application file for complete search history.

(56) **References Cited**

U.S. PATENT DOCUMENTS

D92,898 S * 7/1934 Geddes et al. D6/507
D255,298 S * 6/1980 West D6/395

OTHER PUBLICATIONS

Home Run Impressions by Thomasville, Mar. 1994, p. 3,
bed at top.*

Pennsylvania House, Jun. 1994, p. 146 bed at lower right.*

* cited by examiner

Primary Examiner—Janice E. Seeger

(74) *Attorney, Agent, or Firm*—McGuireWoods LLP

(57) **CLAIM**

The ornamental design for a bed, as shown and described.

DESCRIPTION

FIG. 1 is a top, right, front perspective view of a bed
showing our new, original and ornamental design.

FIG. 2 is a front view of the bed shown in FIG. 1.

FIG. 3 is a side view of the bed shown in FIG. 1.

FIG. 4 is a top view of the bed shown in FIG. 1.

FIG. 5 is a cross-sectional view of the bed shown in FIG. 1
from the foot board to the head board showing the bed's
width can vary; and,

FIG. 6 is a cross-sectional view of the bed shown in FIG. 1
from the side showing the bed's length can vary.

The broken lines are for environmental purposes only and
form no part of the claimed design.

1 Claim, 6 Drawing Sheets

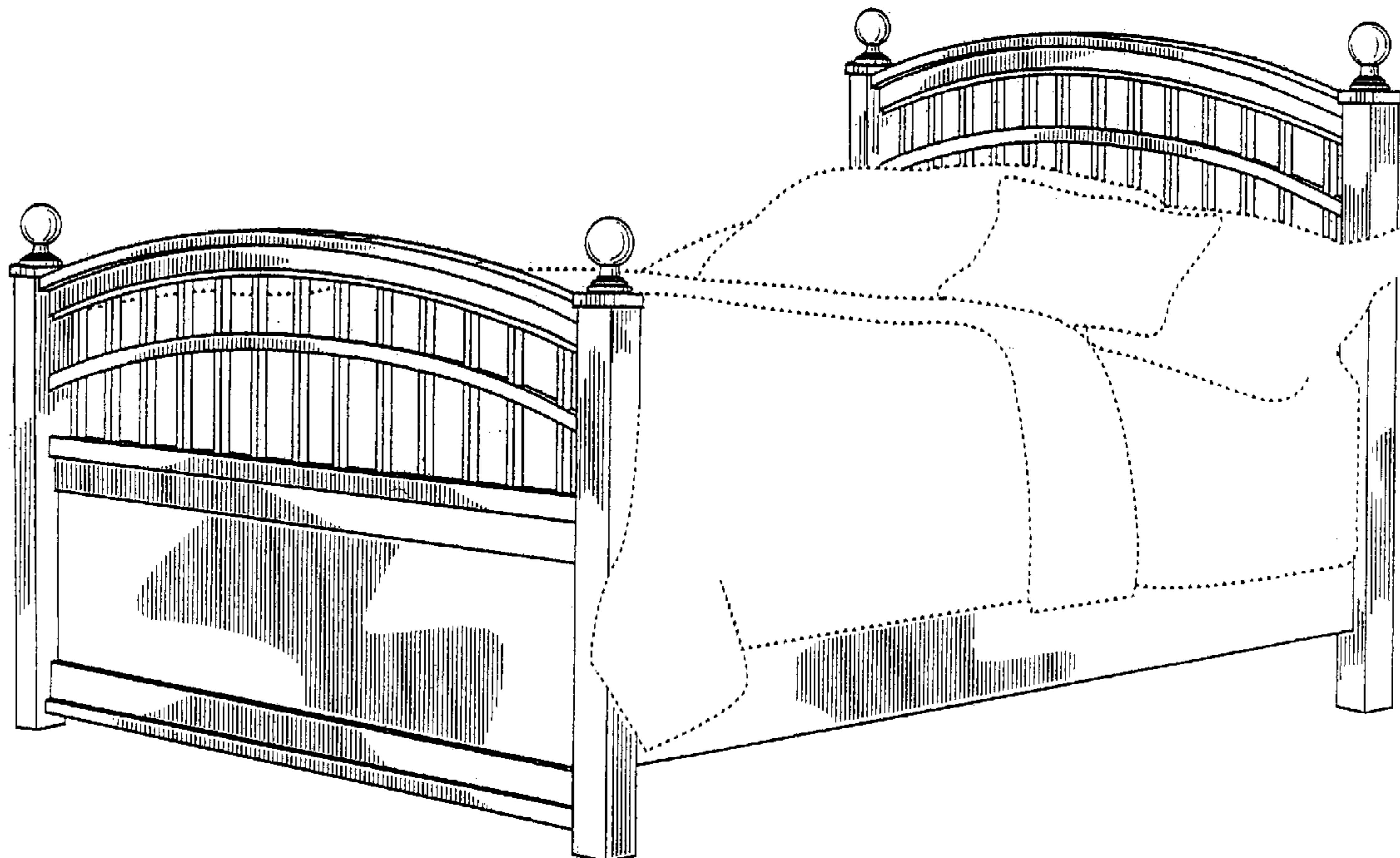

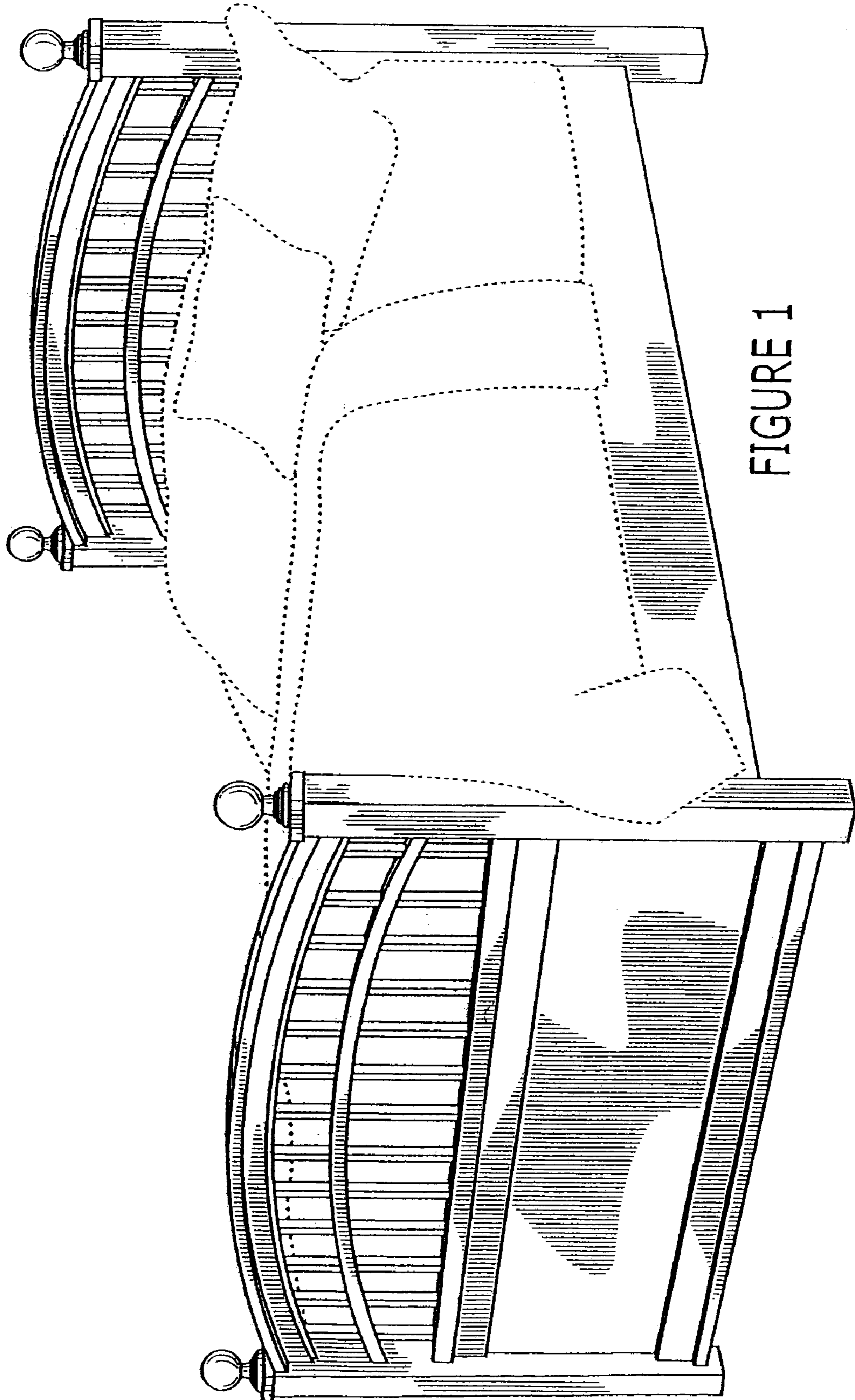

FIGURE 1

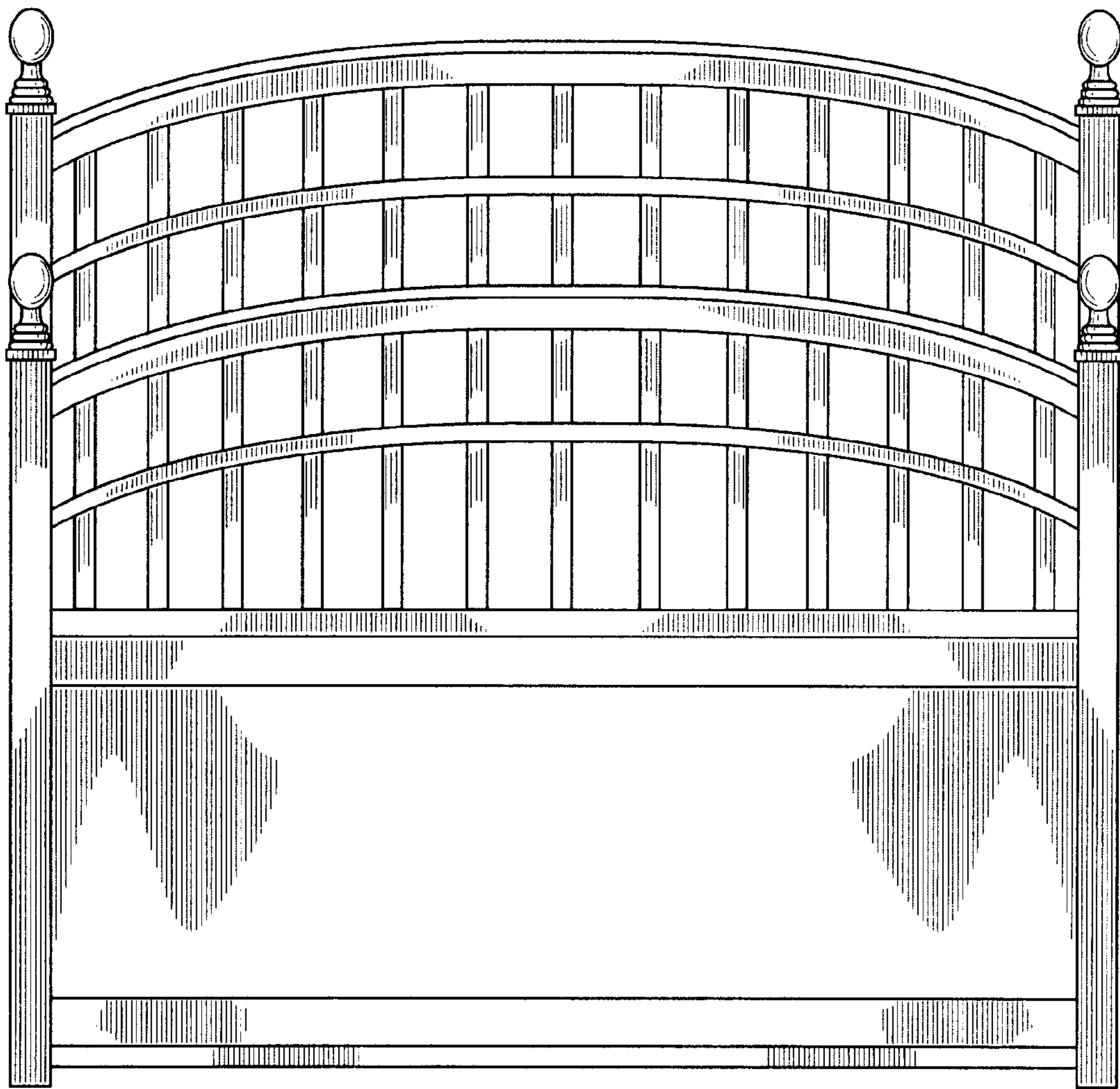

FIGURE 2

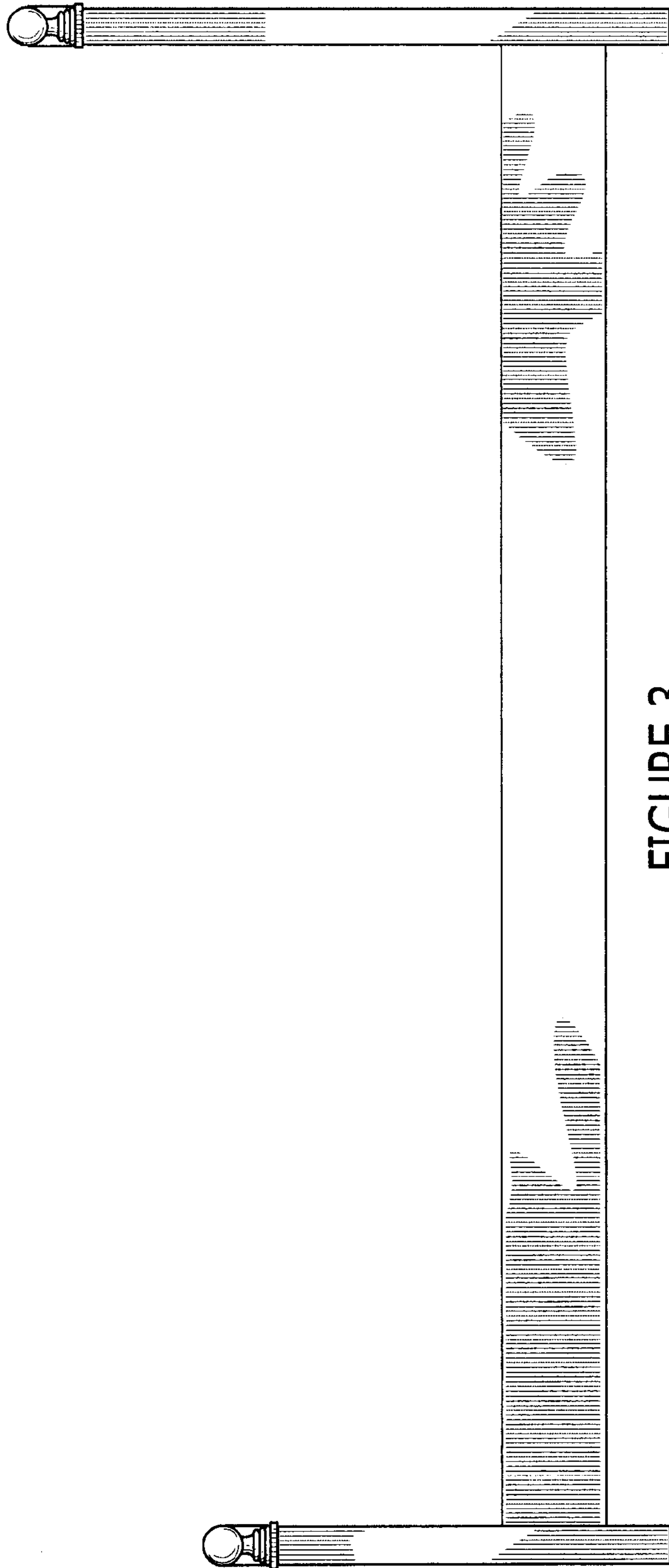

FIGURE 3

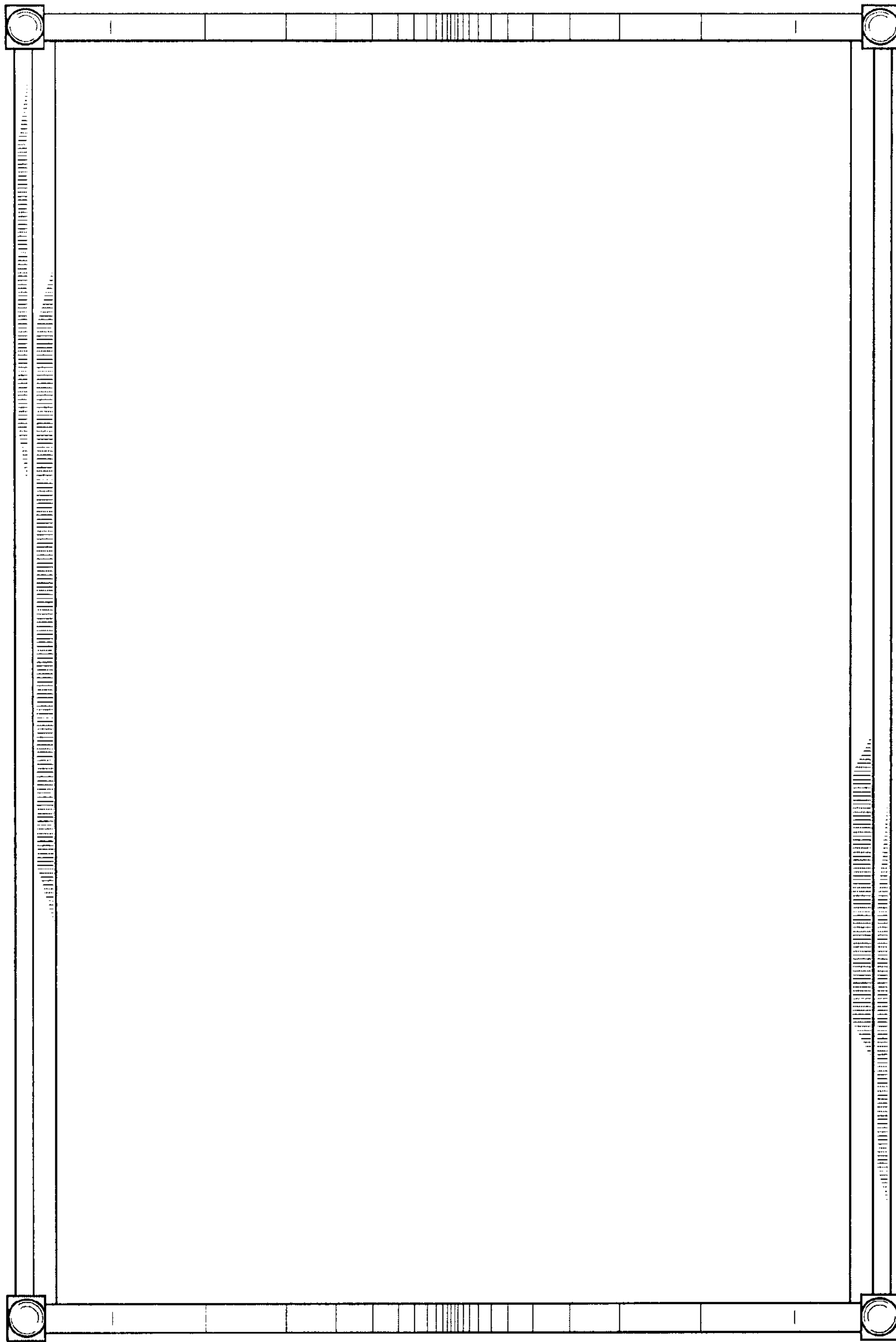

FIGURE 4

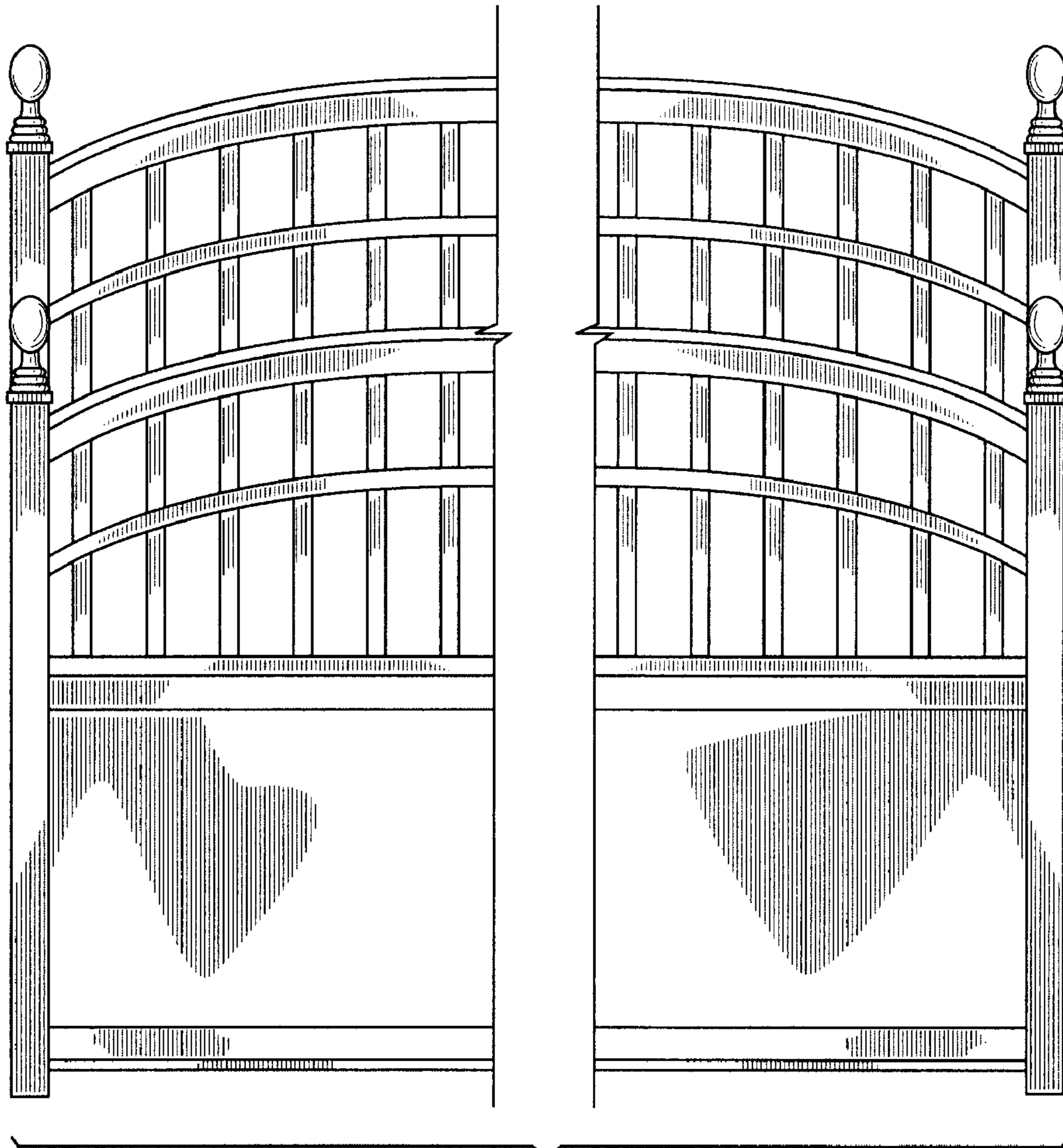

FIGURE 5

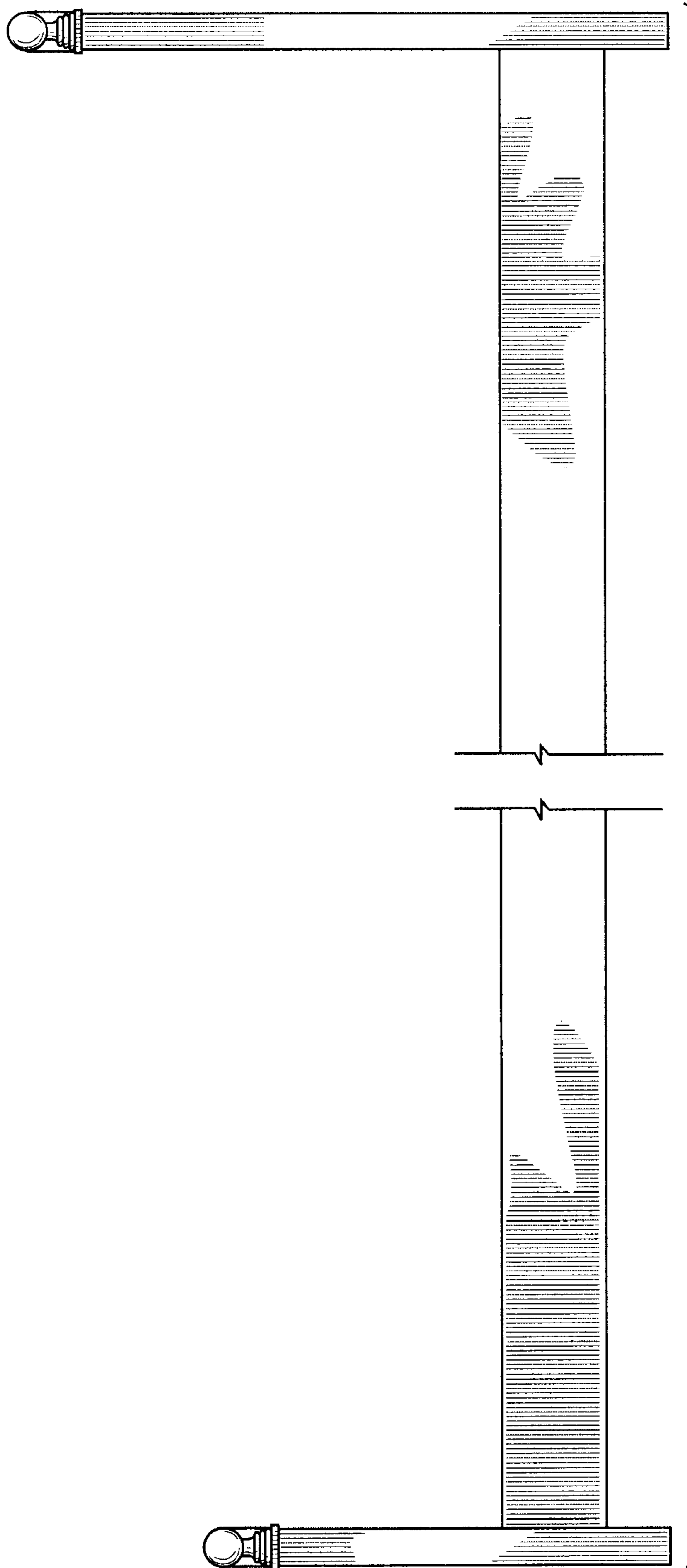

FIGURE 6