

US00D523586S

(12) **United States Design Patent**
Nishizawa

(10) **Patent No.:** **US D523,586 S**

(45) **Date of Patent:** **** Jun. 20, 2006**

(54) **ELECTRIC SHAVER**

(75) Inventor: **Tsuyoshi Nishizawa**, Yokohama (JP)

(73) Assignee: **Matsushita Electric Works, Ltd.**,
Osaka (JP)

(**) Term: **14 Years**

(21) Appl. No.: **29/243,017**

(22) Filed: **Nov. 17, 2005**

(30) **Foreign Application Priority Data**

May 18, 2005 (JP) 2005-014230

(51) **LOC (8) Cl.** **28-03**

(52) **U.S. Cl.** **D28/51**

(58) **Field of Classification Search** D28/44,
D28/45-54; 30/32, 32.05, 34.1, 34.2, 43-43.92,
30/44, 45, 526, 527

See application file for complete search history.

(56) **References Cited**

U.S. PATENT DOCUMENTS

D407,532 S * 3/1999 Jacobs D28/51
D456,946 S * 5/2002 Kling et al. D28/51

D505,751 S * 5/2005 Nagano D28/49
2002/0178586 A1 * 12/2002 Oswald 30/34.1
2005/0172492 A1 * 8/2005 Blaustein et al. 30/43.92

* cited by examiner

Primary Examiner—Jennifer Rivard

(74) *Attorney, Agent, or Firm*—Osha•Liang LLP

(57) **CLAIM**

The ornamental design for an electric shaver, as shown and described.

DESCRIPTION

FIG. 1 is a perspective view of the design according to the invention.

FIG. 2 is a front view of the design according to the invention.

FIG. 3 is a rear view of the design according to the invention.

FIG. 4 is a top view of the design according to the invention.

FIG. 5 is a bottom view of the design according to the invention.

FIG. 6 is a left side view of the design according to the invention; and,

FIG. 7 is a right side view of the design according to the invention.

1 Claim, 3 Drawing Sheets

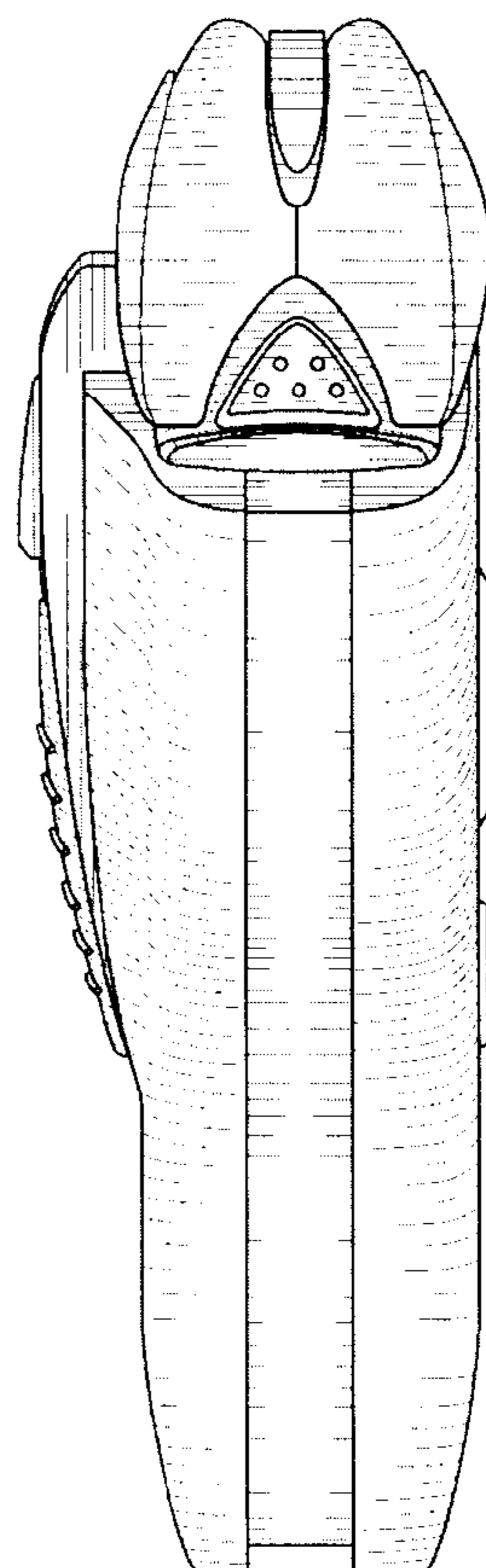
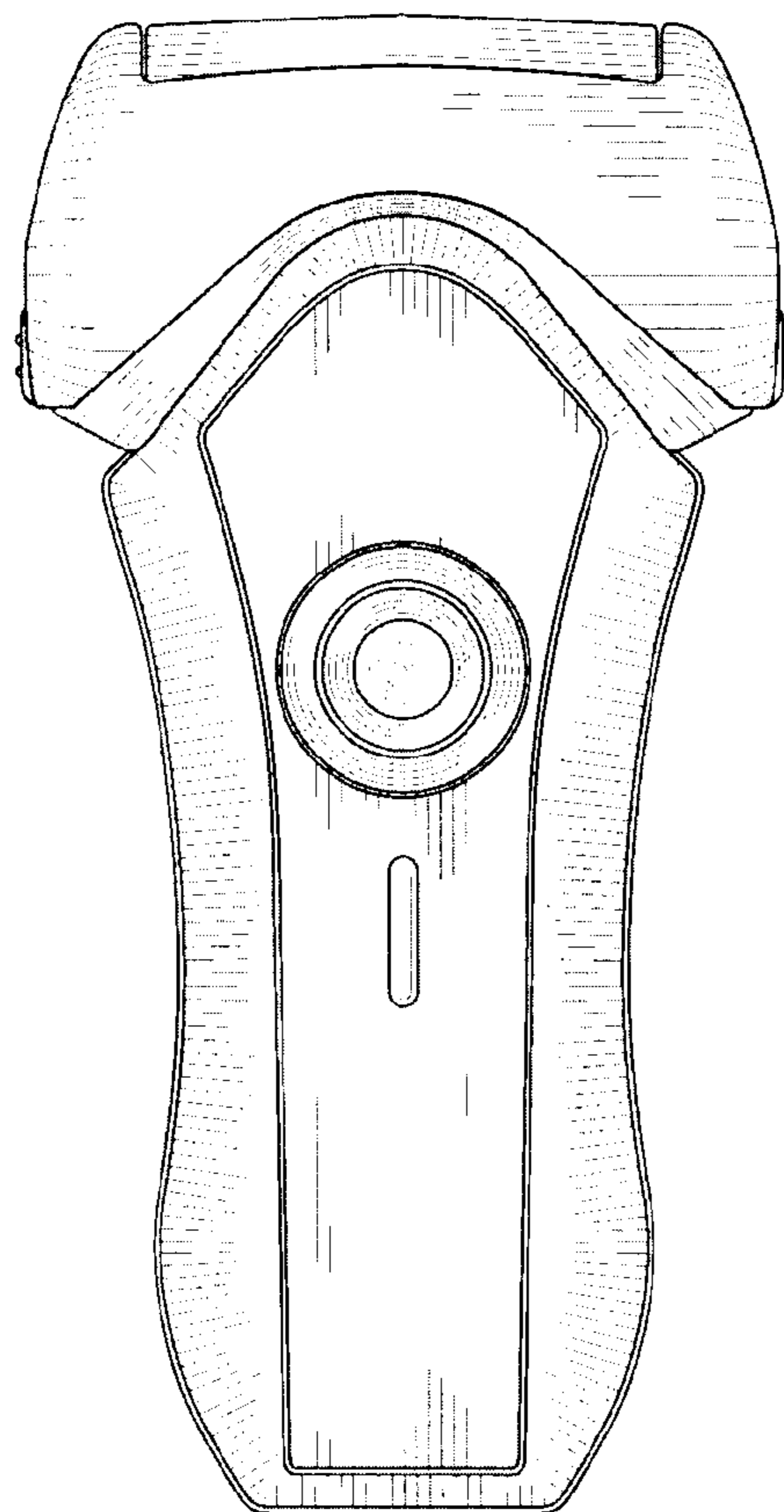

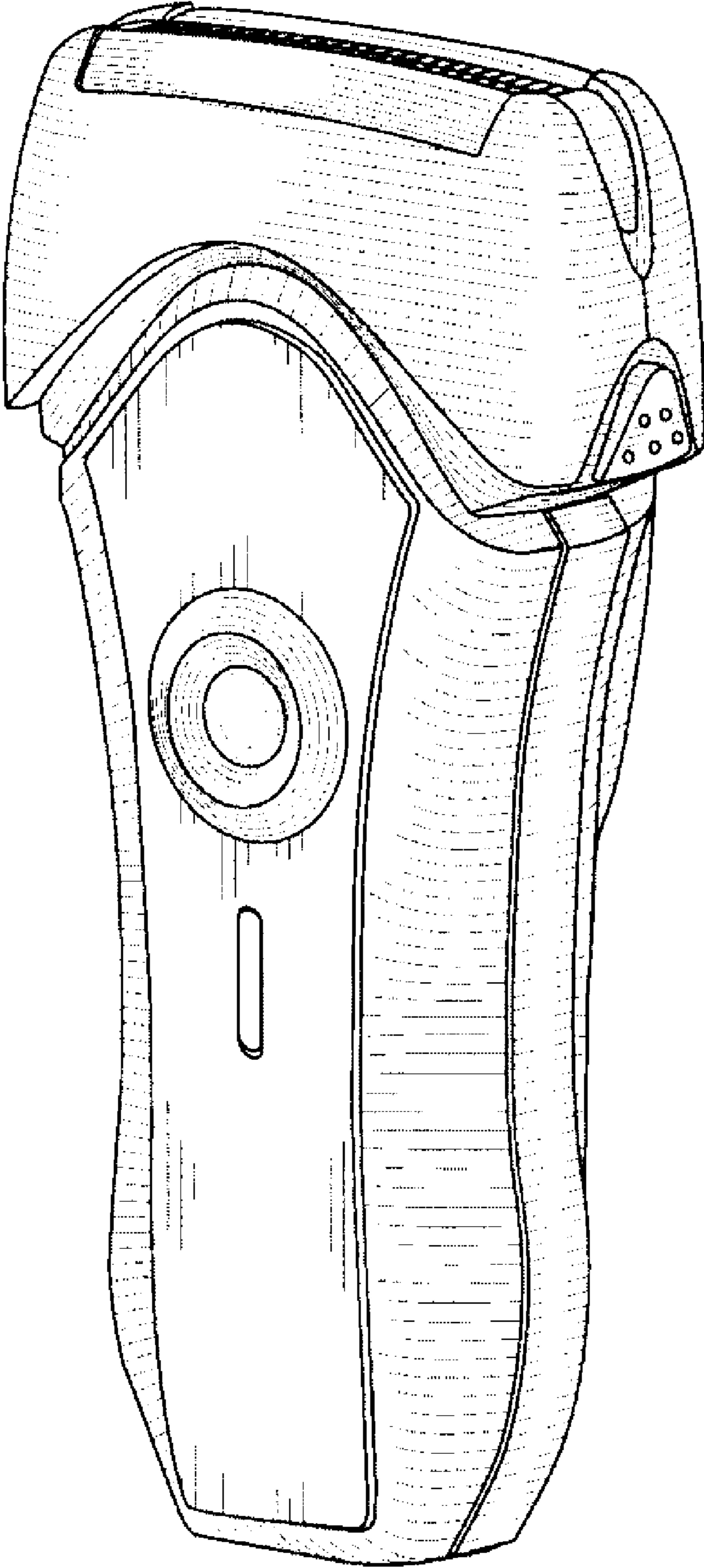

FIG. 1

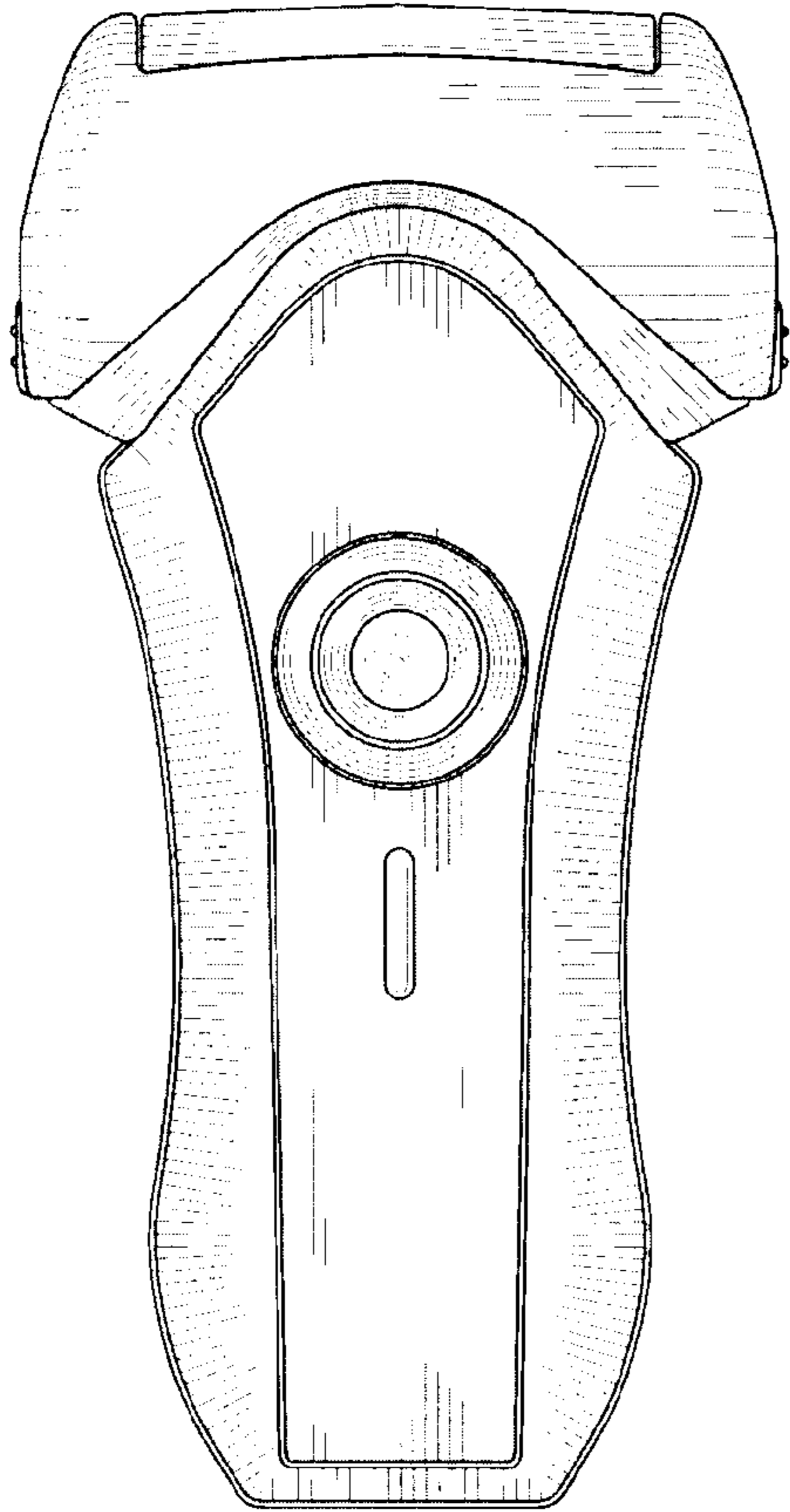

FIG. 2

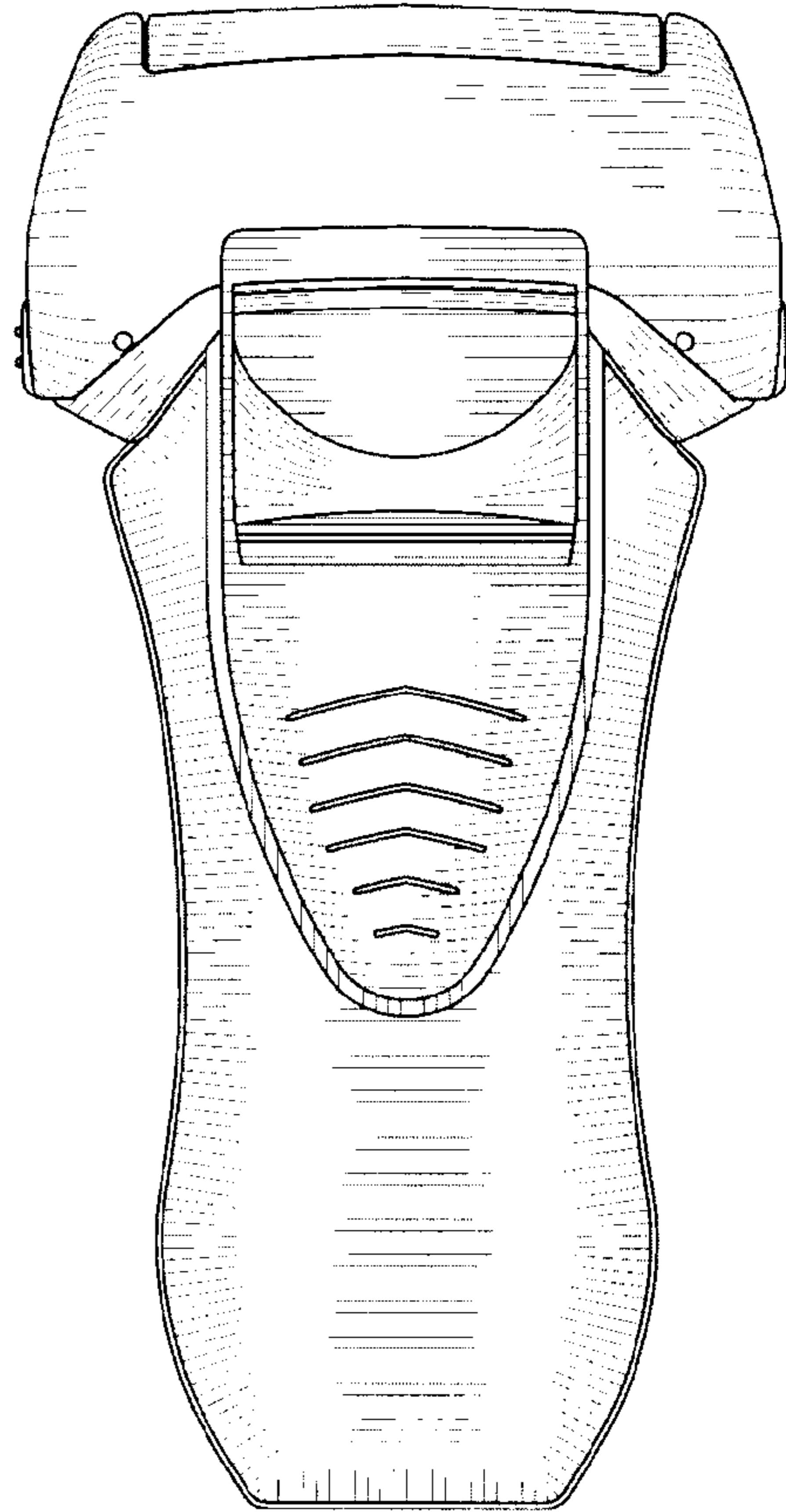

FIG. 3

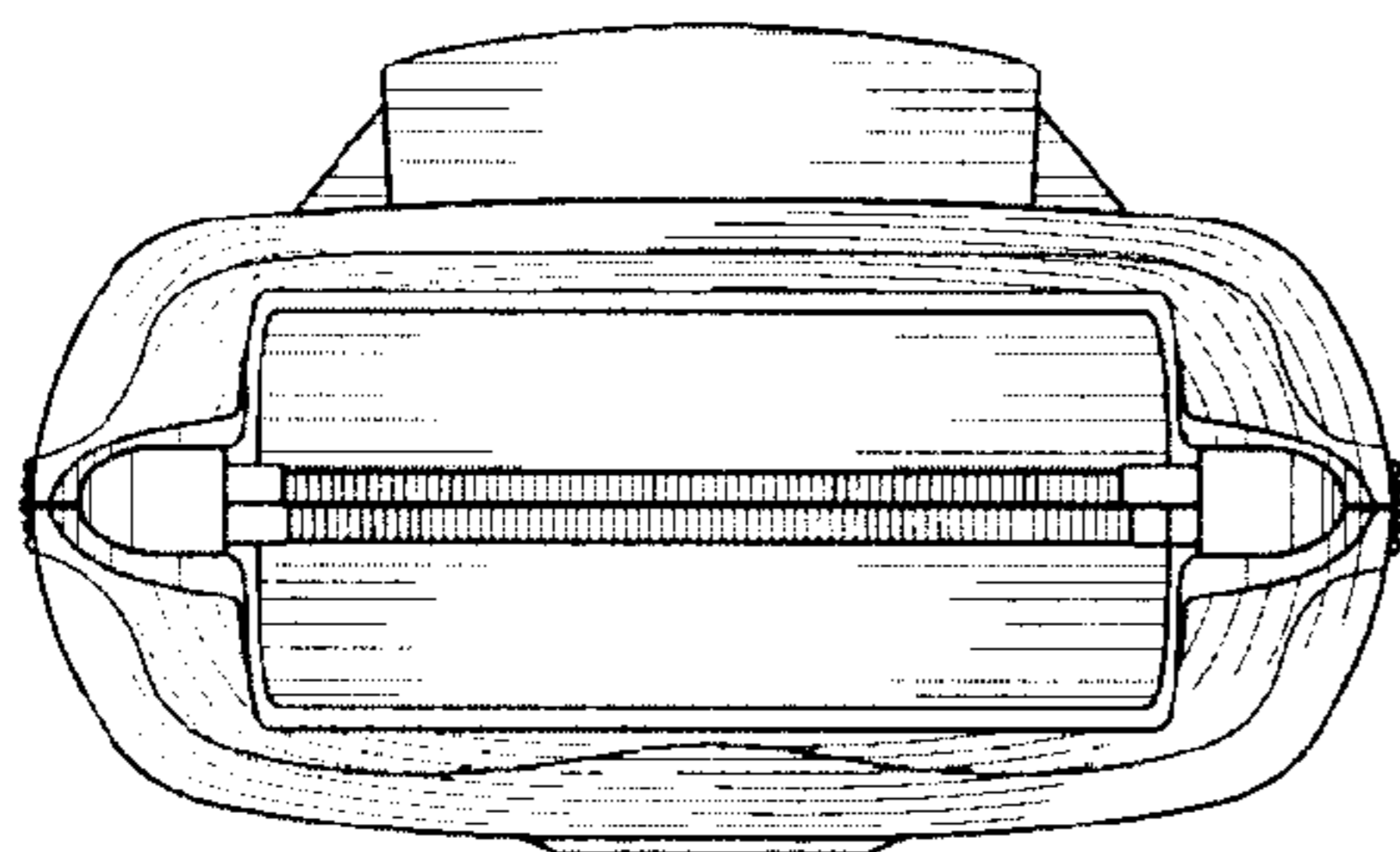

FIG. 4

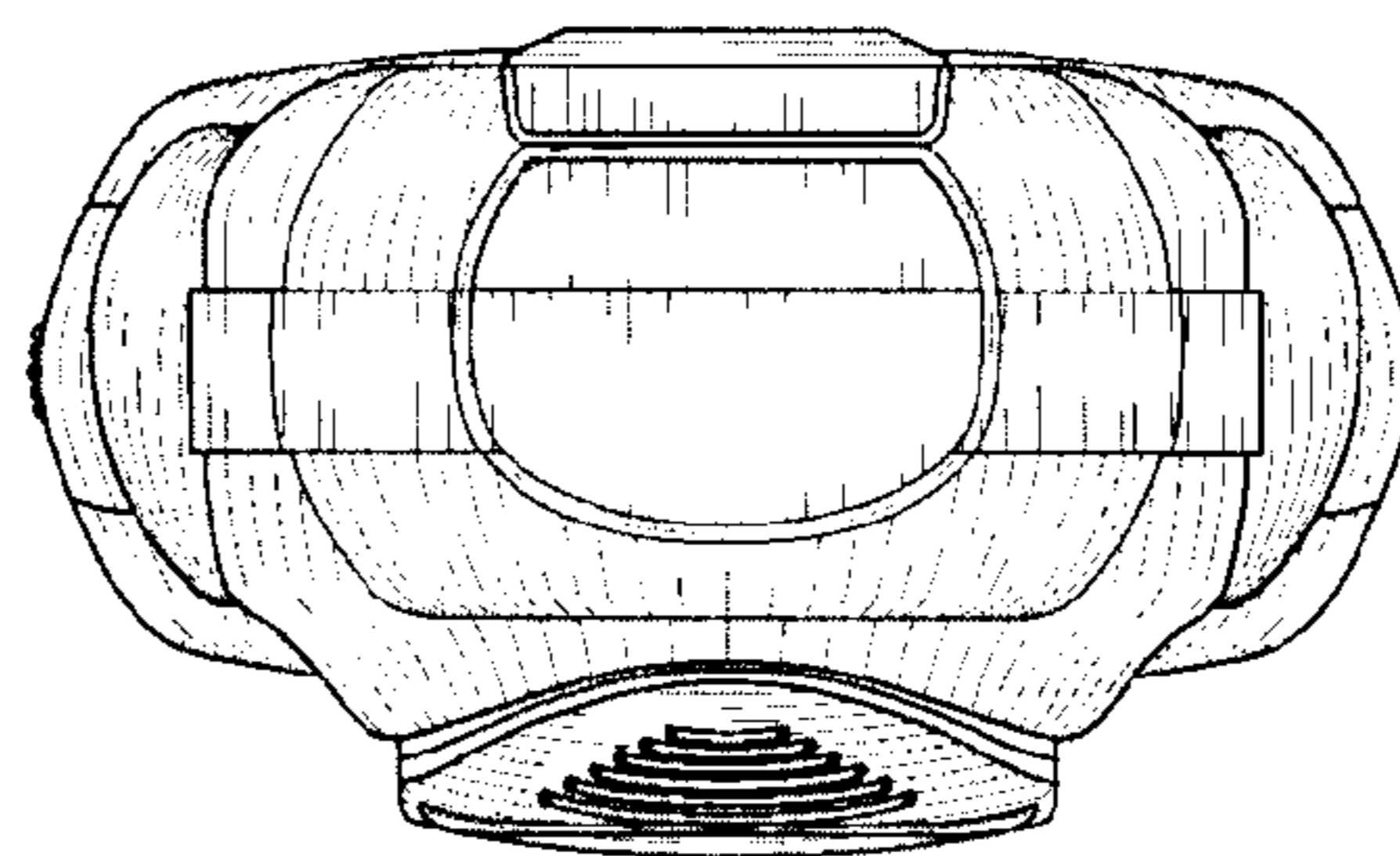

FIG. 5

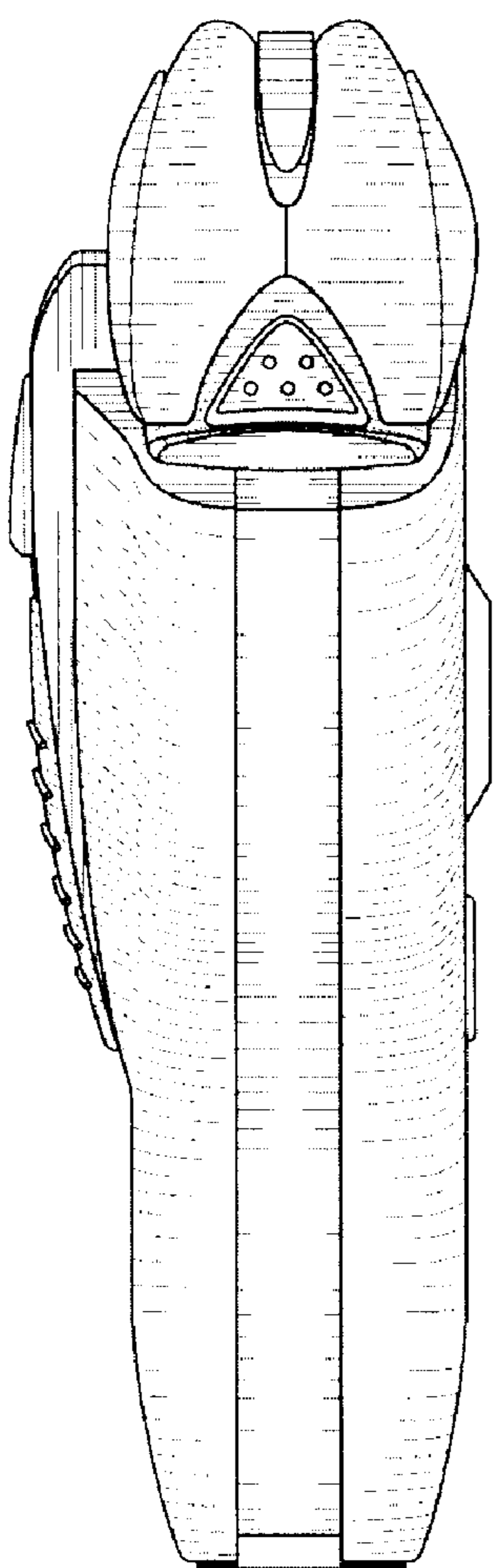

FIG. 6

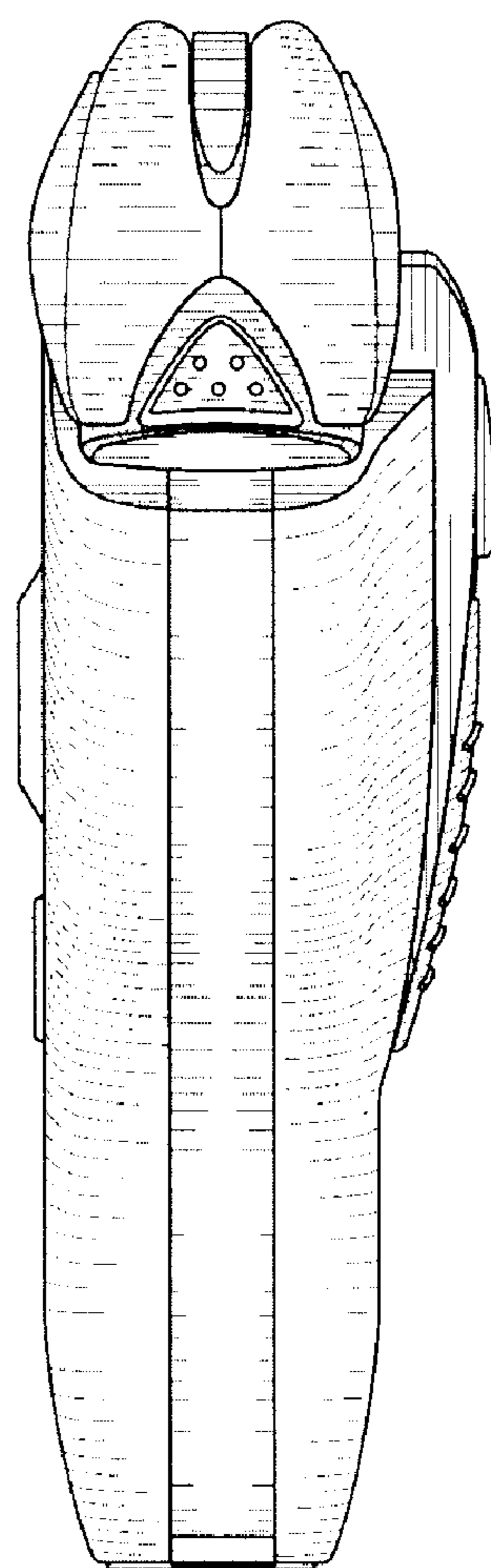

FIG. 7