

US00D523576S

(12) **United States Design Patent**
Chen et al.

(10) **Patent No.:** **US D523,576 S**
(45) **Date of Patent:** **** Jun. 20, 2006**

(54) **COMBINATION OF CAMERA AND FLASHLIGHT**

D496,115 S * 9/2004 Lin D26/49
D502,277 S * 2/2005 Chen D26/49

(75) Inventors: **Tony Chen**, Keelung (TW); **Yu-Hsi Yang**, Taipei (TW); **Li-Wen Wang**, Taipei (TW); **Yi-Lung Weng**, Keelung (TW); **Chaochi Huang**, Taipei (TW)

* cited by examiner

Primary Examiner—Marcus A. Jackson
(74) *Attorney, Agent, or Firm*—Troxell Law Office, PLLC

(73) Assignee: **Quarton Inc.**, Sijhih (TW)

(57) **CLAIM**

(**) Term: **14 Years**

The ornamental design for a combination of camera and flashlight, as shown and described.

(21) Appl. No.: **29/227,212**

(22) Filed: **Apr. 8, 2005**

DESCRIPTION

(30) **Foreign Application Priority Data**

Jan. 28, 2005 (TW) 94300510

FIG. 1 is a perspective view of combination of camera and flashlight from right side showing my design;

(51) **LOC (8) Cl.** **26-02**

(52) **U.S. Cl.** **D26/38**

(58) **Field of Classification Search** D26/37-50;
362/157, 158, 171-174, 183-208

FIG. 2 is a front side view thereof;

FIG. 3 is a rear side view thereof;

FIG. 4 is a top side view thereof;

FIG. 5 is a right side view thereof;

FIG. 6 is a left side view thereof; and,

FIG. 7 is a bottom side thereof.

See application file for complete search history.

(56) **References Cited**

U.S. PATENT DOCUMENTS

6,286,973 B1 * 9/2001 Thrower 362/86

1 Claim, 6 Drawing Sheets

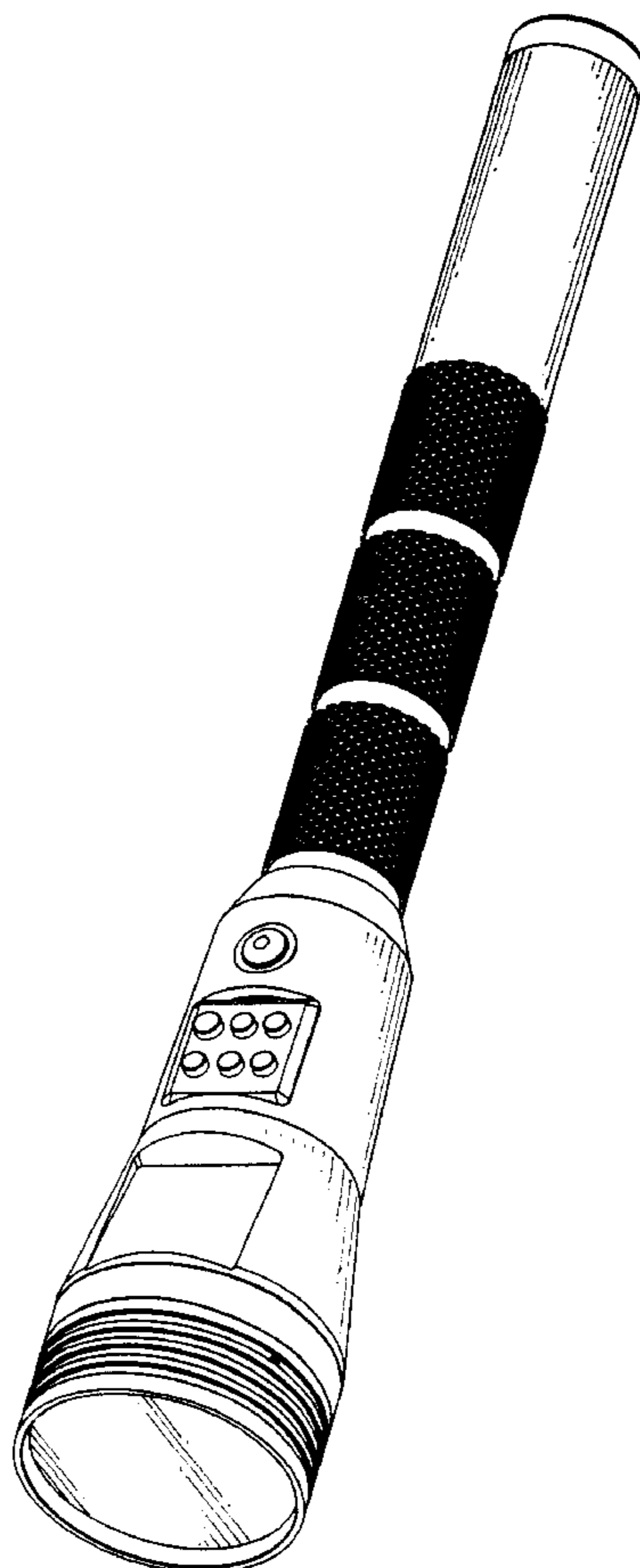

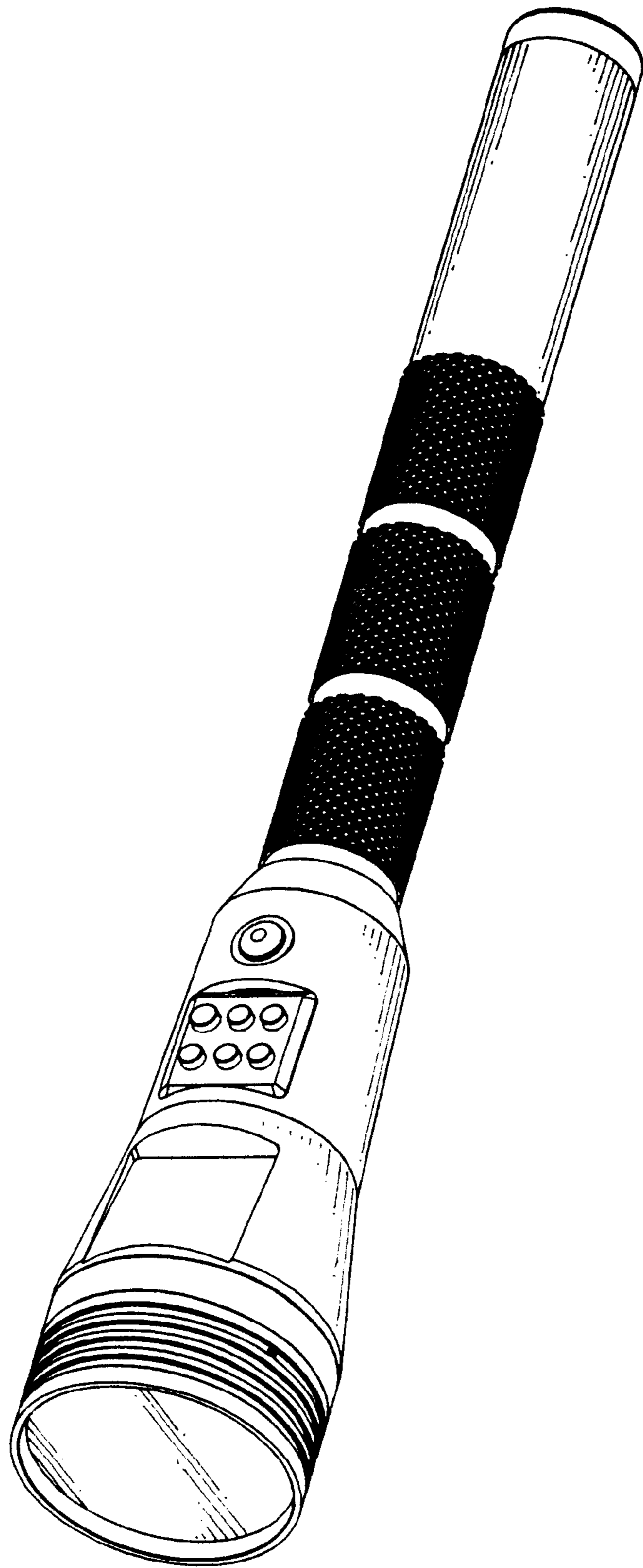

FIG. 1

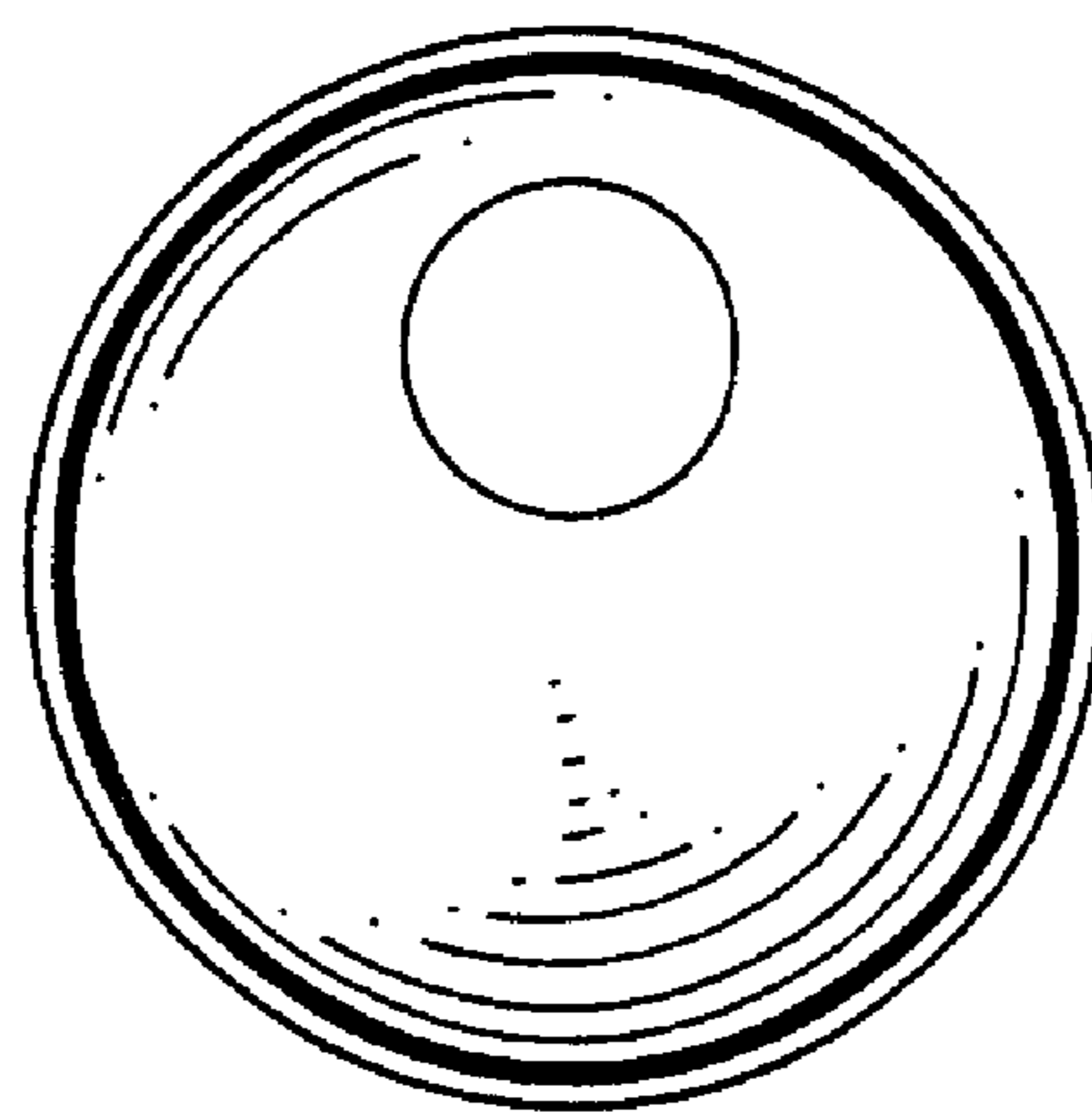

FIG. 2

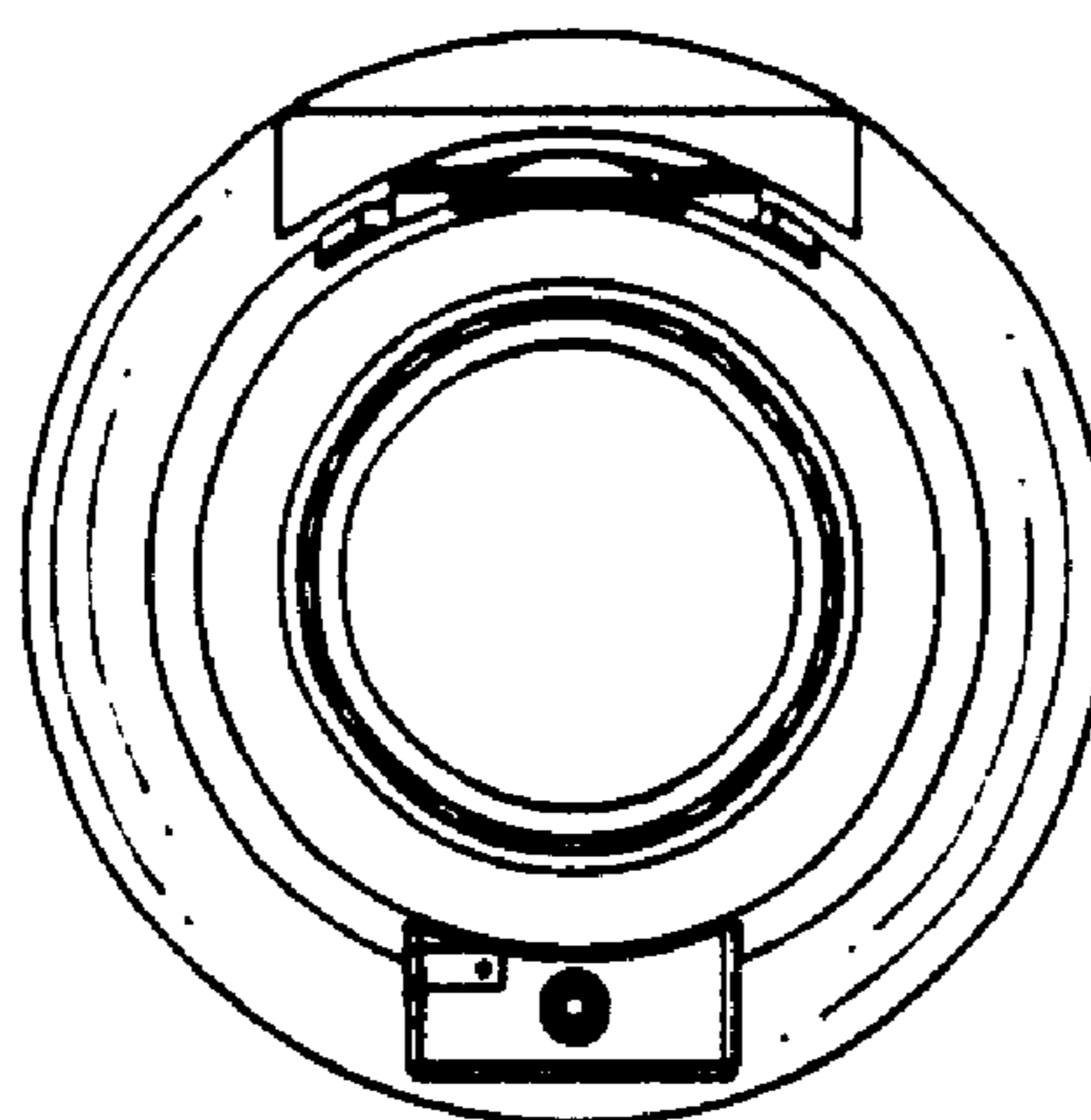

FIG. 3

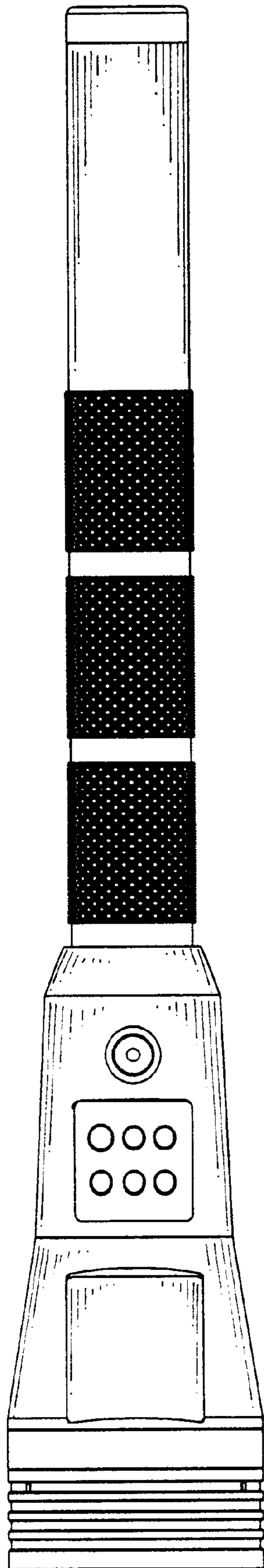

FIG. 4

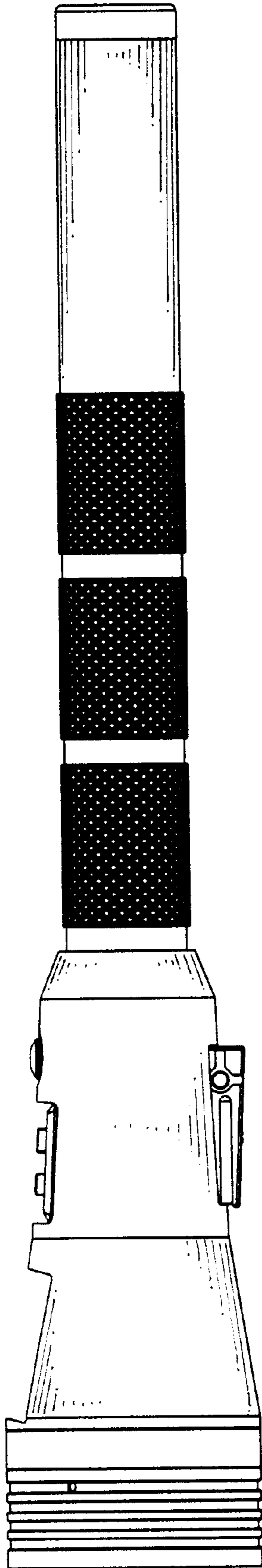

FIG. 5

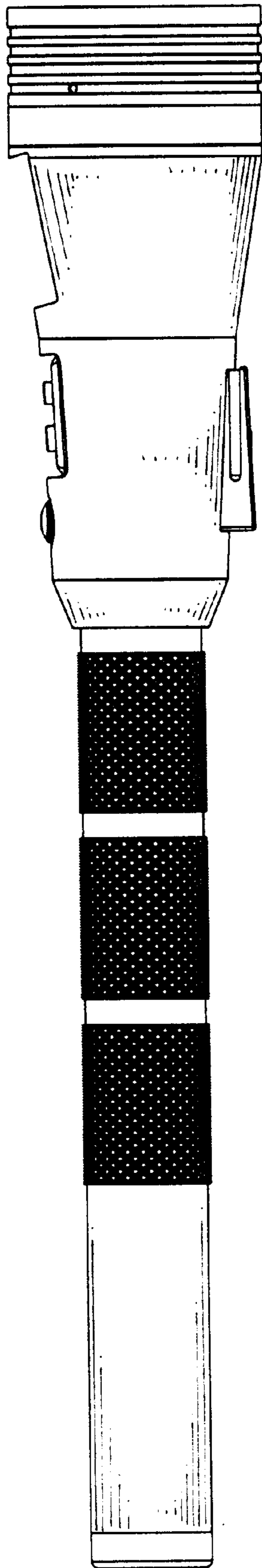

FIG. 6

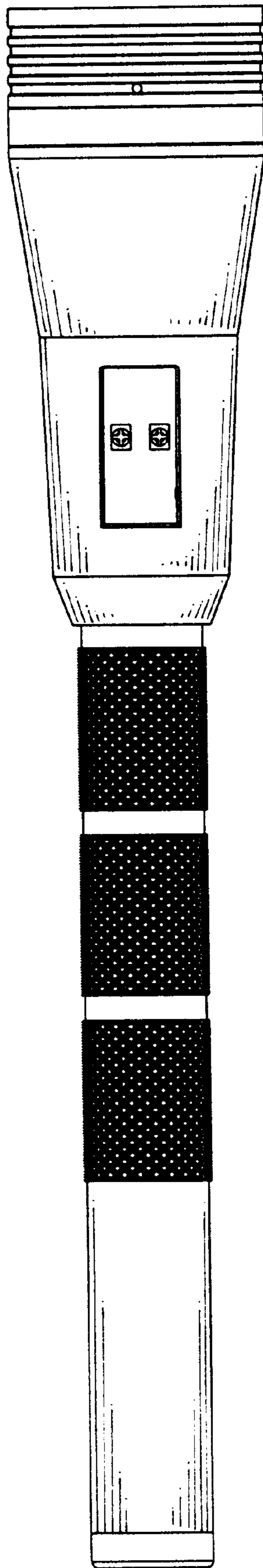

FIG. 7