



US00D523567S

(12) **United States Design Patent**
Whisler

(10) **Patent No.:** **US D523,567 S**

(45) **Date of Patent:** **** Jun. 20, 2006**

(54) **CEMENT BLOCK COVER**

2004/0079039 A1 * 4/2004 Shaw 52/300

(76) Inventor: **Wayne R. Whisler**, 1407 Jen-Ma-Jo
La., Lutz, FL (US) 33549

* cited by examiner

(**) Term: **14 Years**

Primary Examiner—Robert A. Delehanty

(74) *Attorney, Agent, or Firm*—Larson & Larson, PA;
Herbert W. Larson

(21) Appl. No.: **29/201,932**

(57) **CLAIM**

(22) Filed: **Mar. 23, 2004**

The ornamental design for a cement block cover, as shown
and described.

(51) **LOC (8) Cl.** **25-01**

DESCRIPTION

(52) **U.S. Cl.** **D25/199**

(58) **Field of Classification Search** D25/2,
D25/112–113, 119, 164, 199; 52/58, 102,
52/300, 717.03, 717.06, 750; 256/1, 13.1,
256/19

FIG. 1 is a front elevational view of the cement block cover
showing my novel design;

FIG. 2 is a rear elevational view thereof;

FIG. 3 is a left side view thereof;

FIG. 4 is a right side view thereof;

FIG. 5 is a top plan view thereof;

FIG. 6 is a bottom plan view thereof;

FIG. 7 is a perspective view of the cement block cover of the
present invention; and,

FIG. 8 is a perspective view of the cement block cover of the
present invention shown mounted over the top section of a
series of blocks.

See application file for complete search history.

The broken lines shown in FIG. 8 are for illustrative
purposes only and form no part of the overall claimed
design.

(56) **References Cited**

U.S. PATENT DOCUMENTS

2,233,308	A	*	2/1941	Duffy	52/300
2,291,974	A	*	8/1942	Miller et al.	52/300
3,142,069	A	*	7/1964	O'Connell et al.	52/300
3,802,140	A	*	4/1974	Hickman	52/300
3,822,863	A	*	7/1974	Bidwell	256/13.1
2003/0000166	A1	*	1/2003	Arignon	52/300

1 Claim, 5 Drawing Sheets

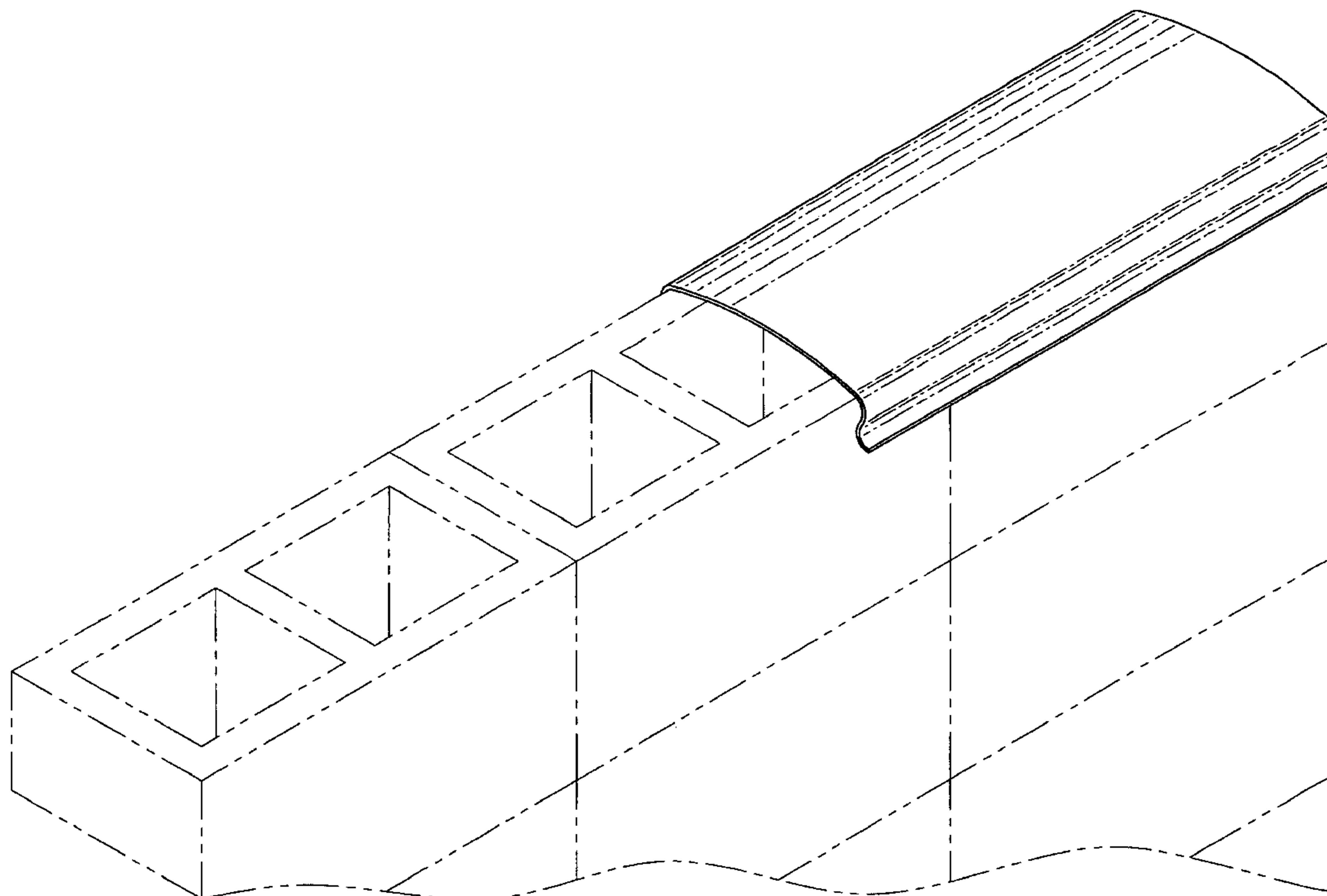

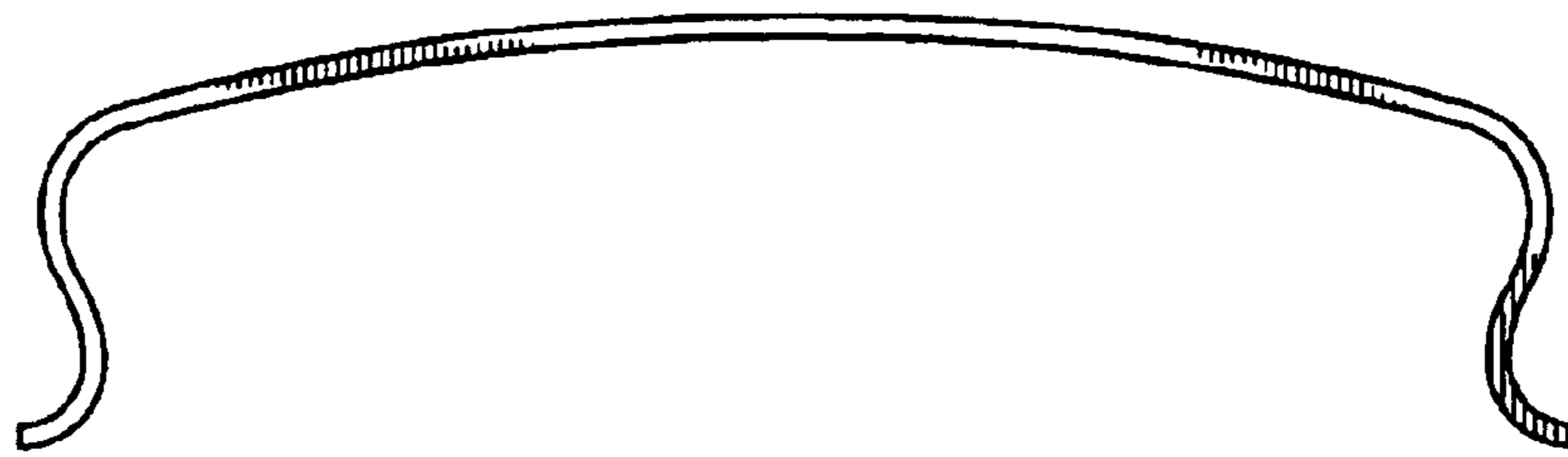

FIG. 1



FIG. 2

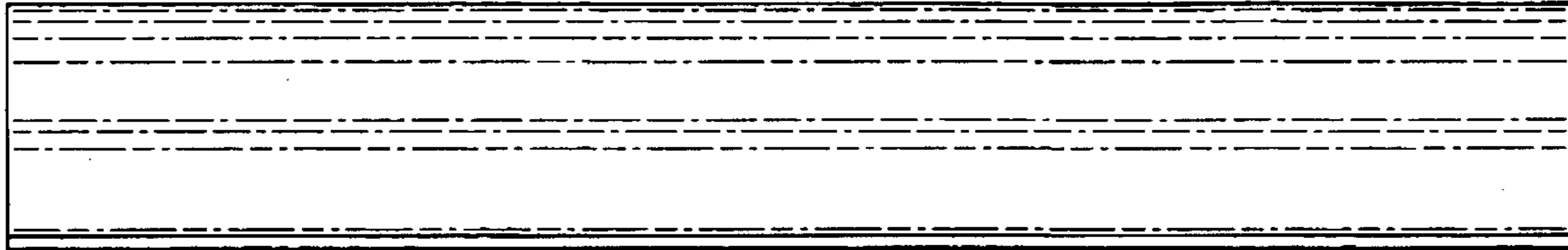

FIG. 3

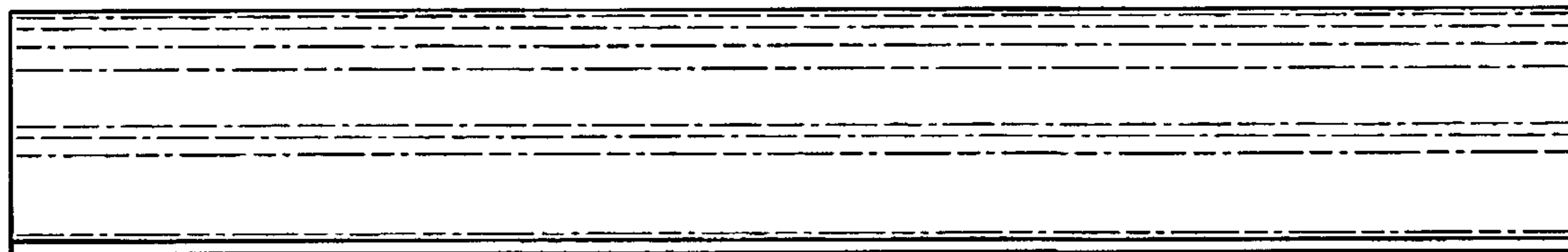

FIG. 4



FIG. 6

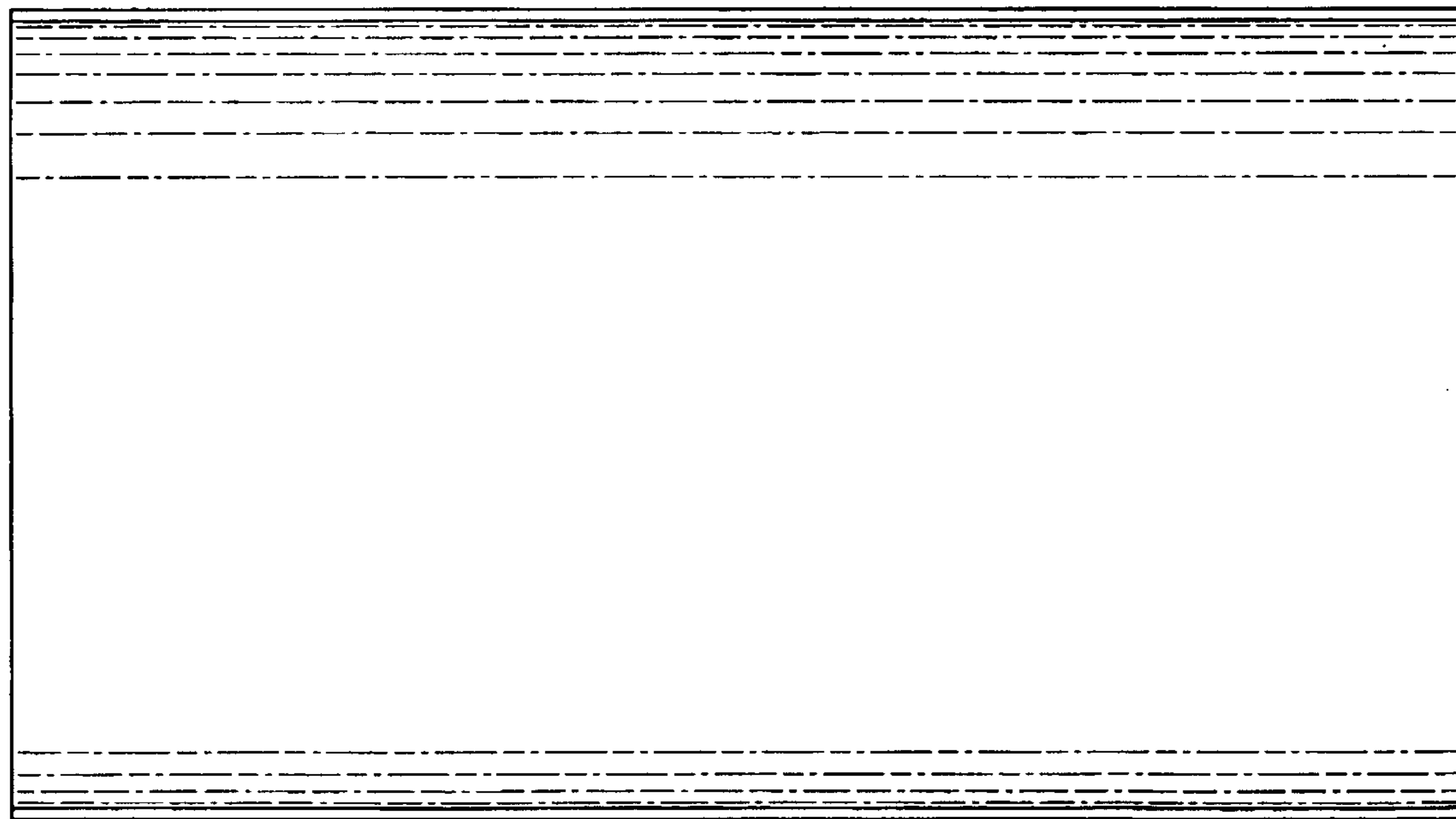

FIG. 5

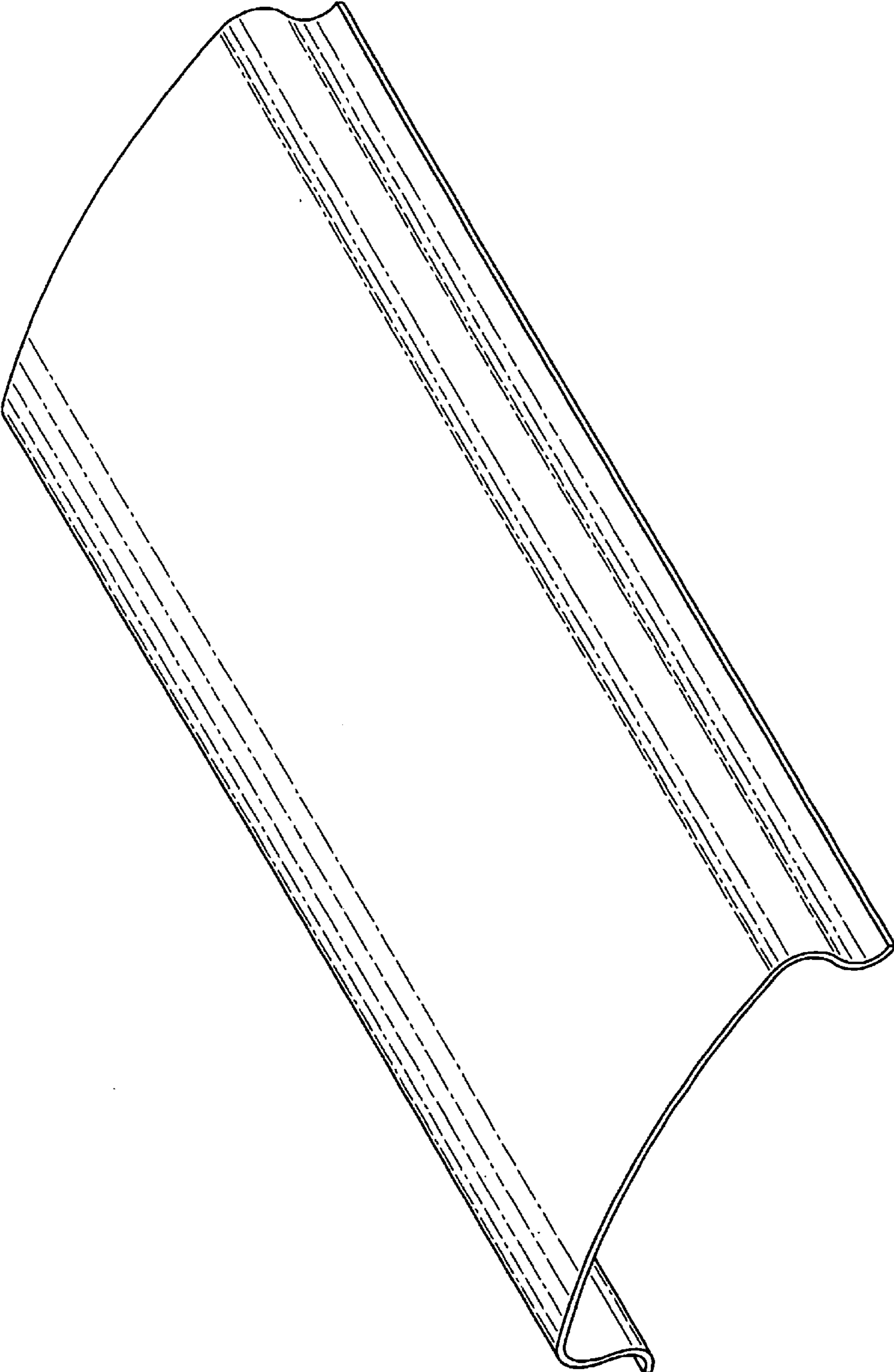

FIG. 7

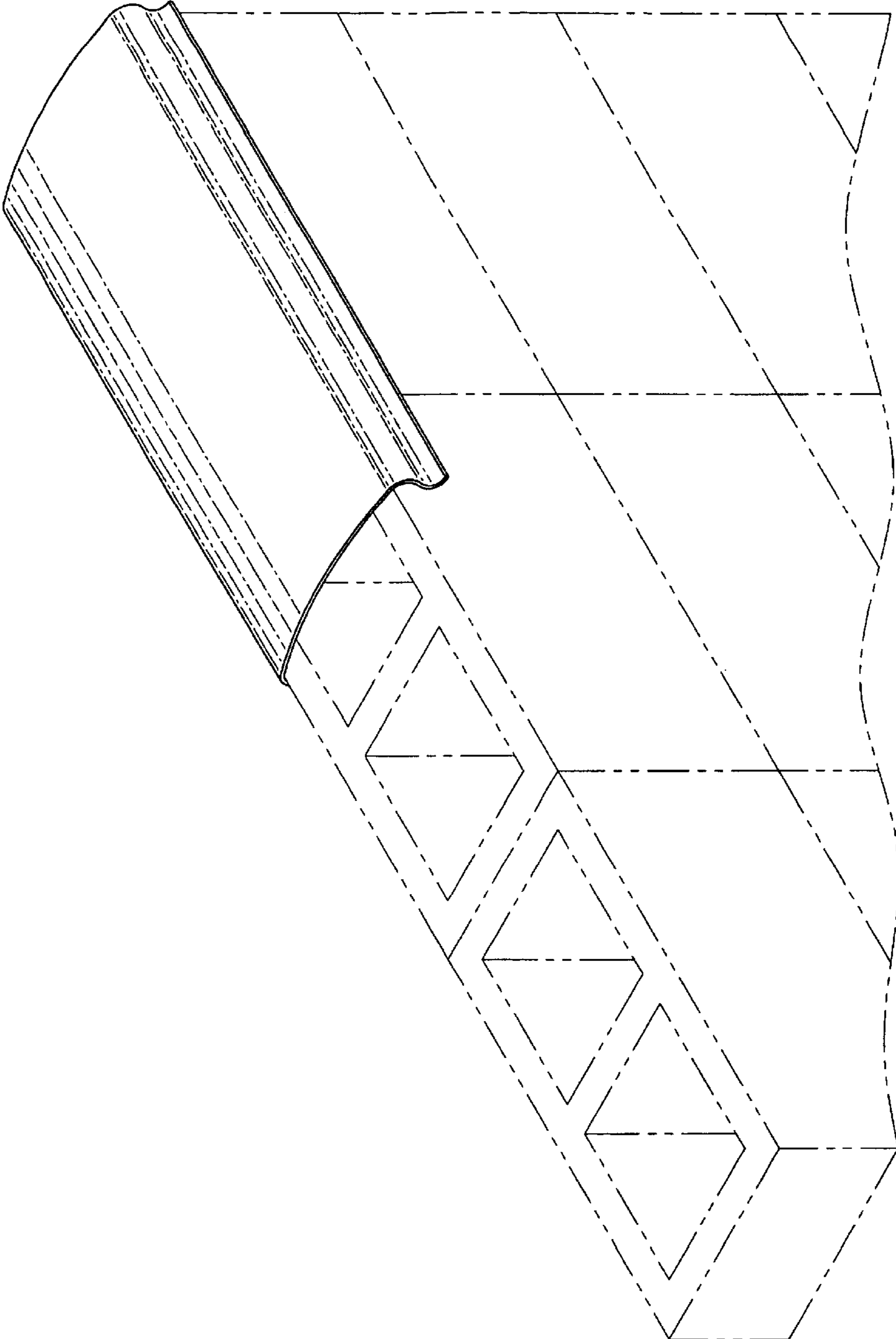

FIG. 8