



US00D523565S

(12) **United States Design Patent**  
**Antonic**

(10) **Patent No.:** **US D523,565 S**

(45) **Date of Patent:** **\*\* Jun. 20, 2006**

(54) **SILL PLATE**

(76) **Inventor:** **James P. Antonic**, 9111 Southmont  
Cove #406, Ft. Myers, FL (US) 33908

(\*\*) **Term:** **14 Years**

(21) **Appl. No.:** **29/233,443**

(22) **Filed:** **Jul. 1, 2005**

**Related U.S. Application Data**

(63) Continuation of application No. 11/116,769, filed on Apr. 28, 2005.

(51) **LOC (8) Cl.** ..... **25-01**

(52) **U.S. Cl.** ..... **D25/119**

(58) **Field of Classification Search** ..... D25/119;  
52/271, 272, 270, 317, 731.7; 49/467  
See application file for complete search history.

(56) **References Cited**

**U.S. PATENT DOCUMENTS**

D286,199	S	*	10/1986	Bancroft	.....	D25/119
4,630,547	A	*	12/1986	Przybylinski et al.	.....	105/416
5,611,173	A	*	3/1997	Headrick et al.	.....	49/468
5,644,888	A		7/1997	Johnson		
5,794,746	A	*	8/1998	Ketonen et al.	.....	187/333
6,003,279	A		12/1999	Schneider		
6,092,340	A		7/2000	Simmons		
6,216,395	B1	*	4/2001	Kelly	.....	49/467
D446,870	S	*	8/2001	Gardner	.....	D25/136
6,272,796	B1		8/2001	Metzler		
6,276,094	B1		8/2001	Hays		
D447,574	S	*	9/2001	Fening	.....	D25/119
6,314,704	B1		11/2001	Bryant		

6,427,403	B1		8/2002	Tambakis		
6,438,903	B1		8/2002	Weiss		
6,581,337	B1		6/2003	Skov et al.		
6,684,573	B1	*	2/2004	Heath et al.	.....	49/467
6,754,999	B1		6/2004	Urbanczyk		
6,789,358	B1	*	9/2004	Procton et al.	.....	49/471
2002/0069600	A1		6/2002	Bryant		
2002/0092245	A1		7/2002	Floyd et al.		
2003/0089066	A1		5/2003	Nelson		

**OTHER PUBLICATIONS**

U.S. Appl. No. 29/233,444, filed Jul. 1, 2005, Antonic.  
U.S. Appl. No. 29/233,441, filed Jul. 1, 2005, Antonic.  
U.S. Appl. No. 29/233,442, filed Jul. 1, 2005, Antonic.

\* cited by examiner

*Primary Examiner*—Doris Clark

(74) *Attorney, Agent, or Firm*—Laura G. Barrow

(57) **CLAIM**

I claim the ornamental design of a sill plate, as shown and described.

**DESCRIPTION**

FIG. 1 is a perspective view of the sill plate showing my new design, shown broken in the center with a double line to indicate that no particular length is claimed.

FIG. 2 is a front elevation thereof.

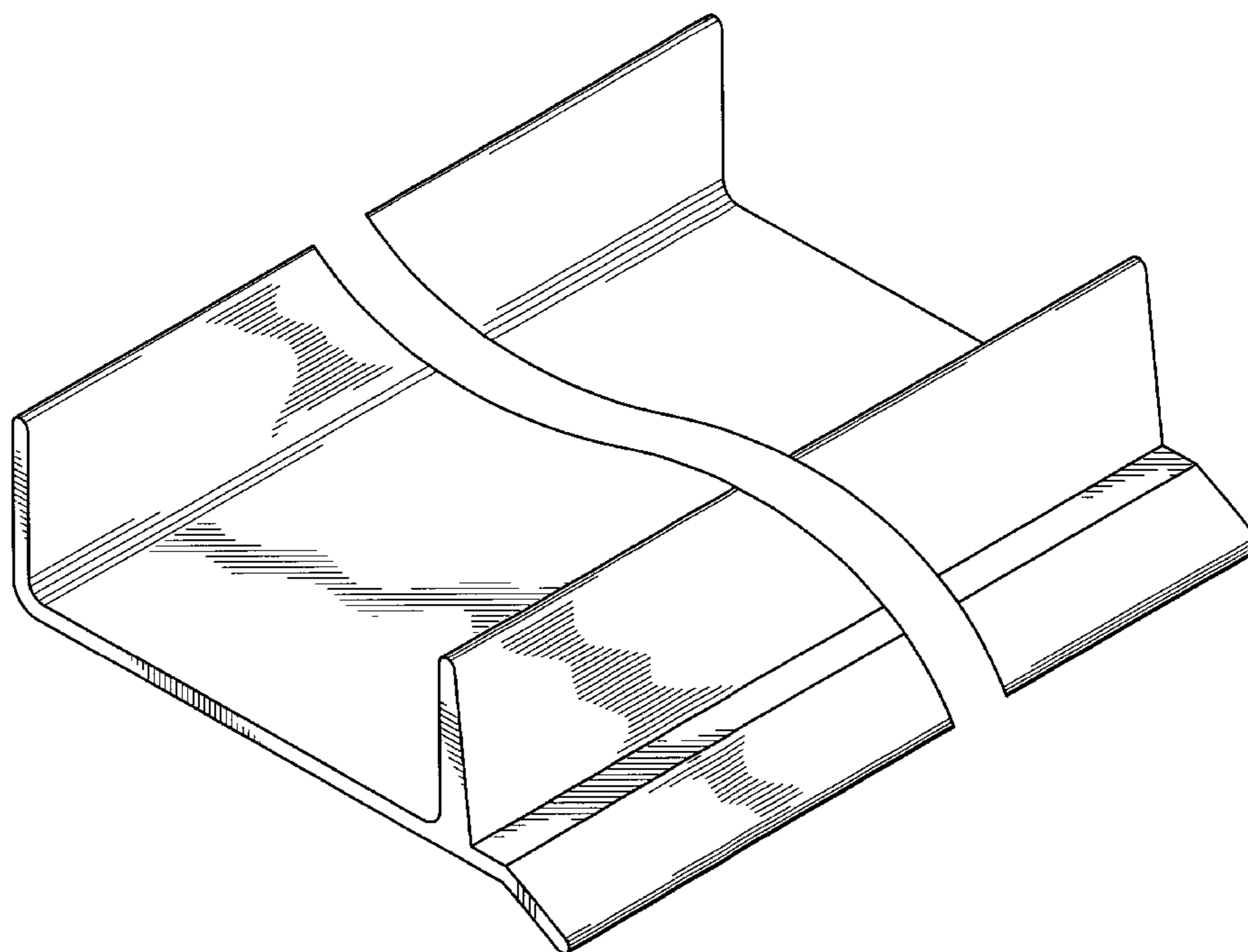
FIG. 3 is a rear elevation thereof.

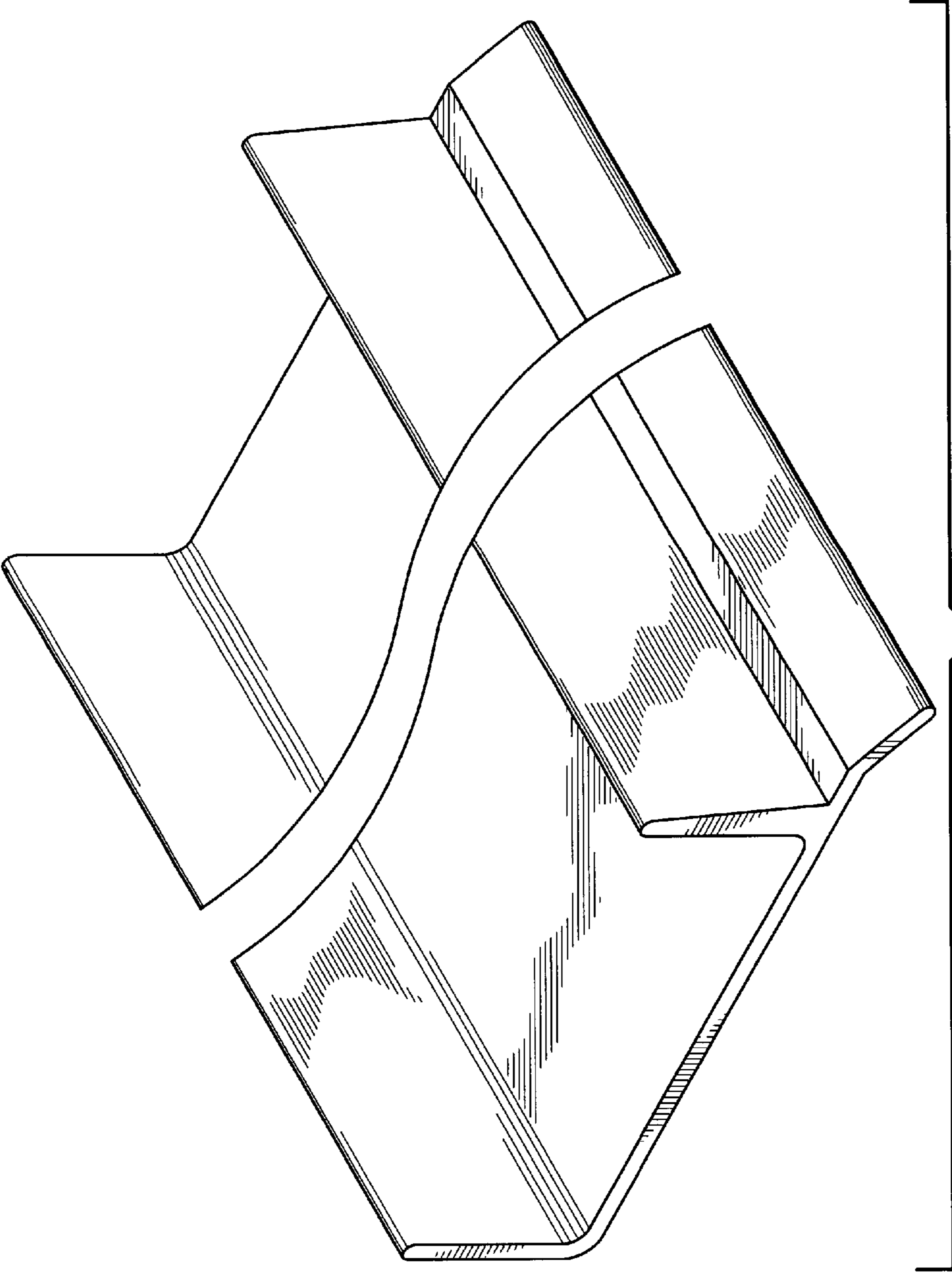
FIG. 4 is a side elevation views thereof. The right and left sides of the sill plate are identical.

FIG. 5 is a top plan view thereof; and,

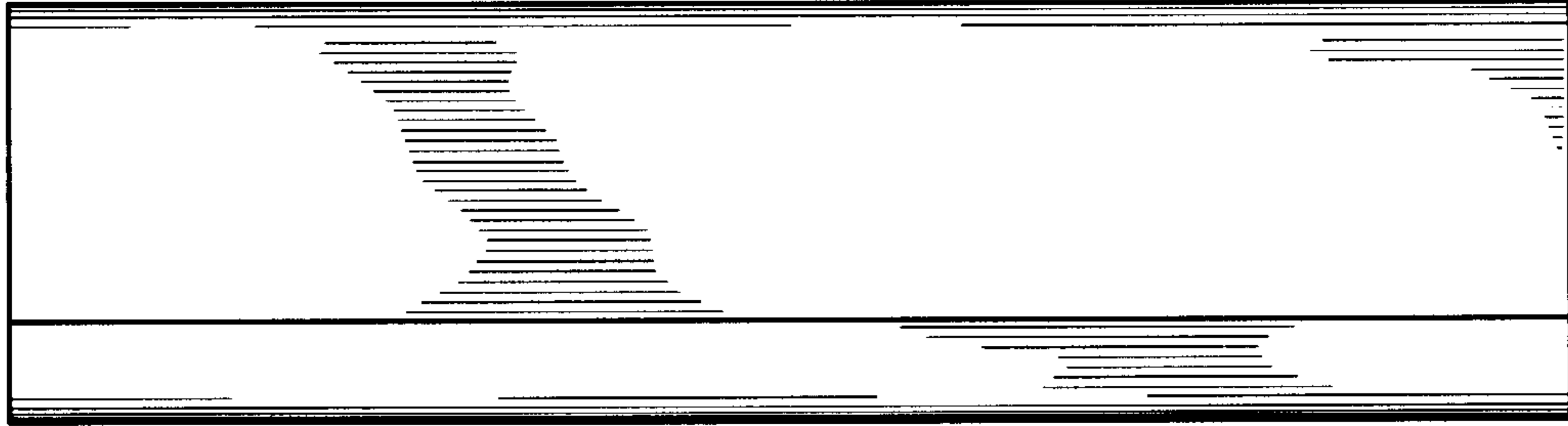
FIG. 6 is a bottom plan view thereof.

**1 Claim, 3 Drawing Sheets**

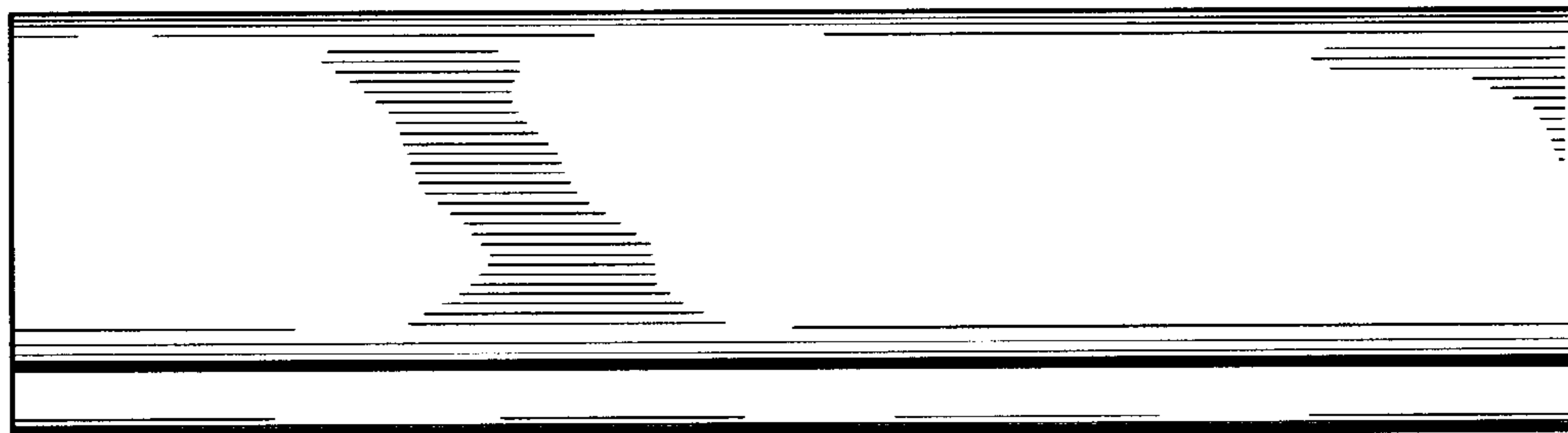




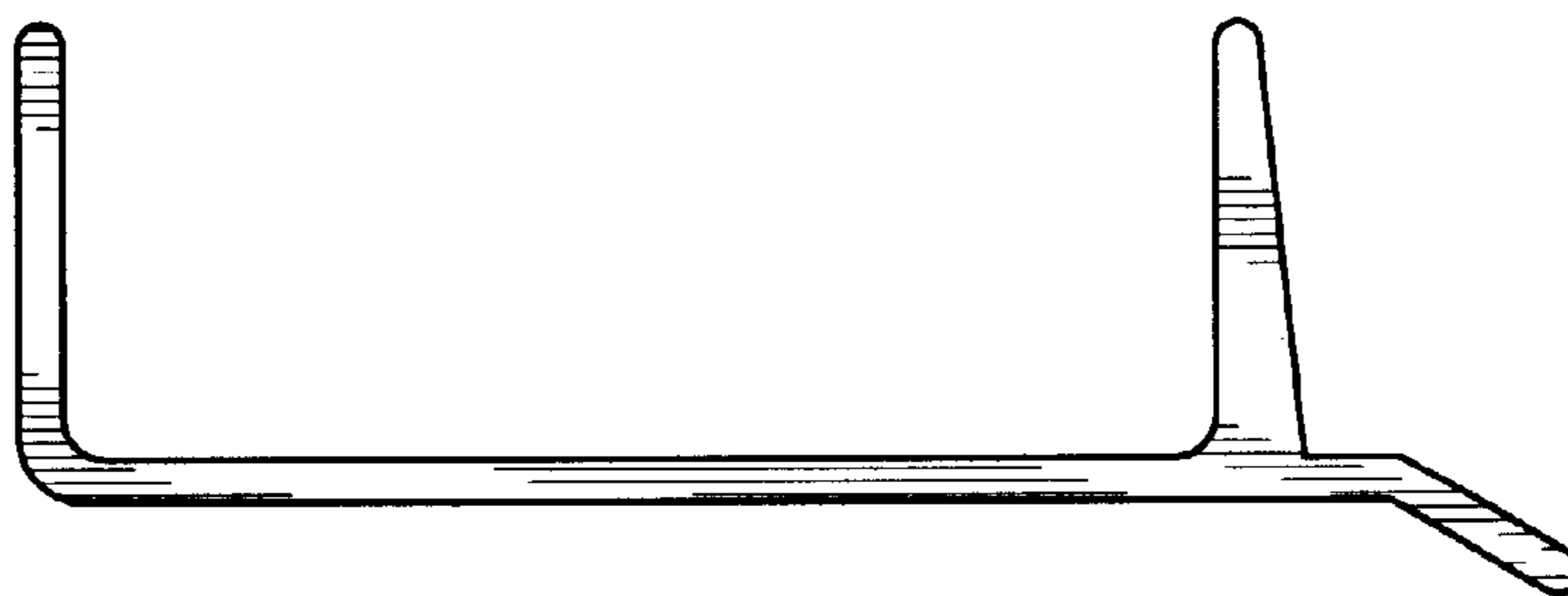
*Fig. 1*



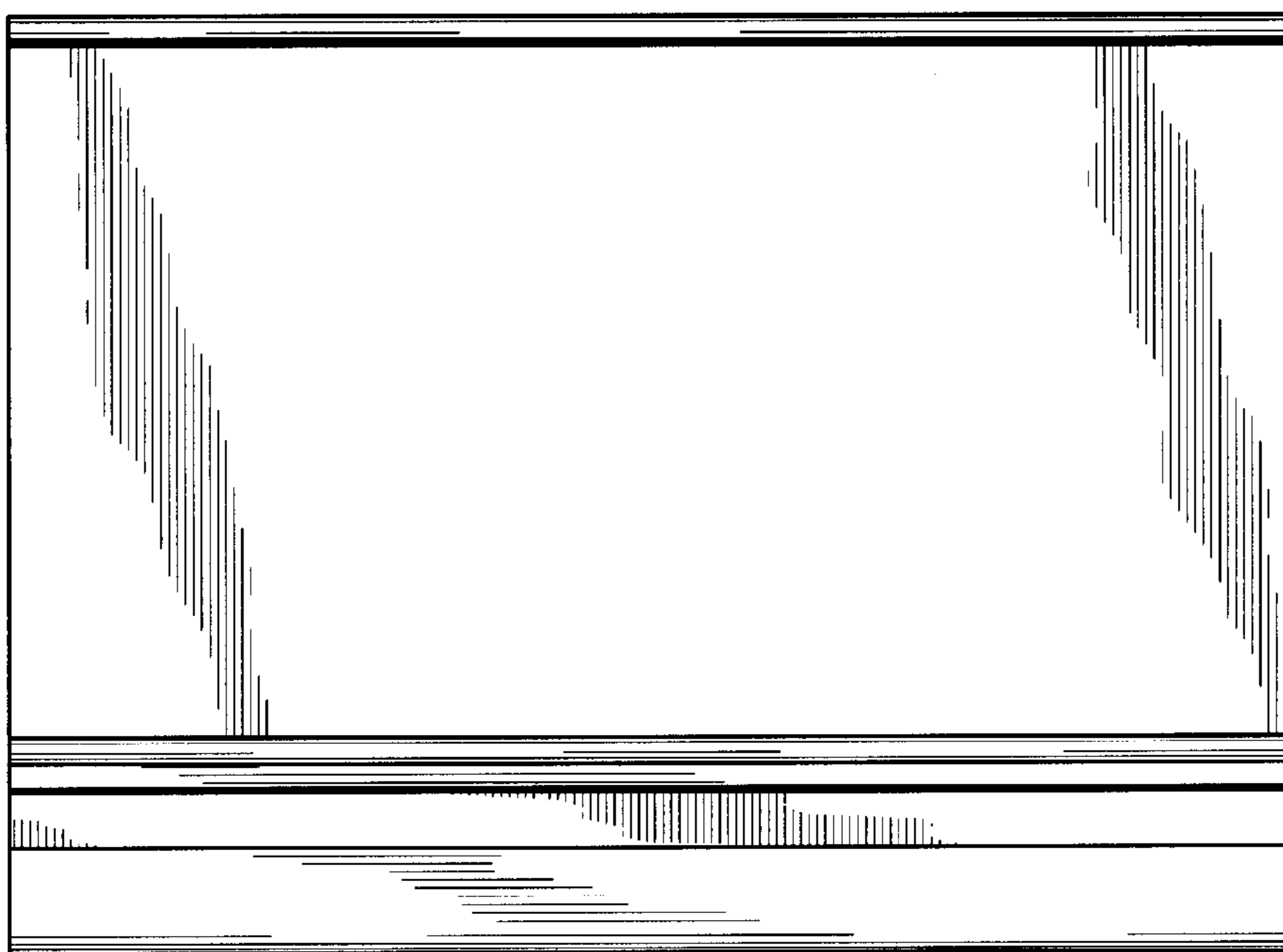
*Fig. 2*



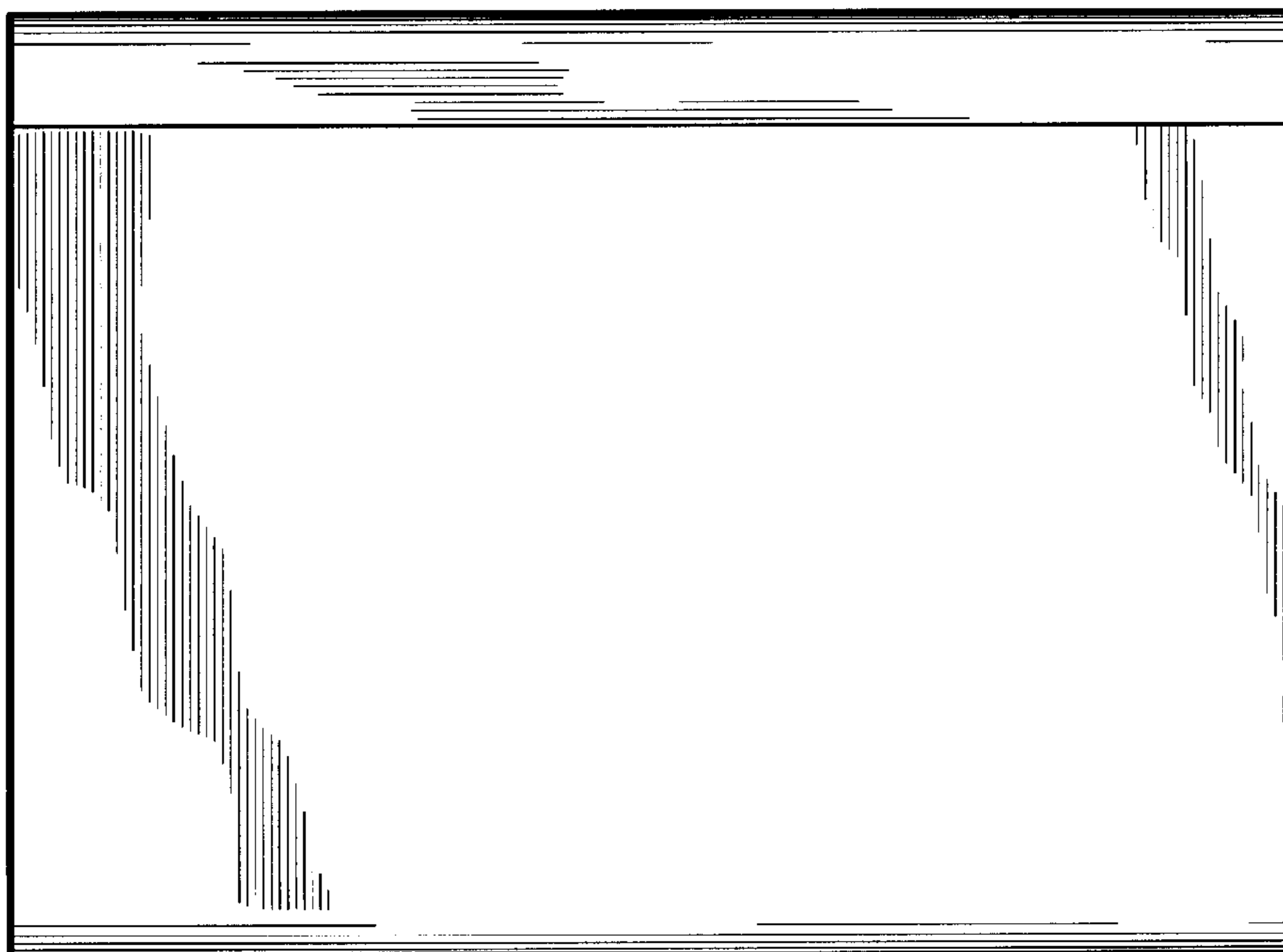
*Fig. 3*



*Fig. 4*



*Fig. 5*



*Fig. 6*