



US00D523435S

(12) **United States Design Patent**  
**Takiar et al.**

(10) **Patent No.:** **US D523,435 S**  
(45) **Date of Patent:** **\*\* Jun. 20, 2006**

(54) **MEMORY CARD**

(75) Inventors: **Hem P. Takiar**, Fremont, CA (US);  
**Michael W. Patterson**, Portland, OR (US)

(73) Assignee: **Sandisk Corporation**, Sunnyvale, CA (US)

(\*\*) Term: **14 Years**

(21) Appl. No.: **29/194,064**

(22) Filed: **Nov. 19, 2003**

**Related U.S. Application Data**

(63) Continuation-in-part of application No. 29/186,546, filed on Jul. 17, 2003.

(51) **LOC (8) Cl.** ..... **14-02**

(52) **U.S. Cl.** ..... **D14/436**

(58) **Field of Classification Search** ..... D14/432-38;  
361/736-7, 686; D13/182, 184; 40/124.01;  
235/487-95, 441-3, 375; 283/900, 904; 257/378-9;  
174/52.1; 439/135, 140, 76.1; D19/9, 10  
See application file for complete search history.

(56) **References Cited**

**U.S. PATENT DOCUMENTS**

D439,579 S 3/2001 Auclair et al.  
D442,598 S 5/2001 Wallace et al.

(Continued)

**FOREIGN PATENT DOCUMENTS**

JP D1076068 6/2000  
JP D1076069 6/2000

(Continued)

**OTHER PUBLICATIONS**

The MultiMedia Card System Summary, Version 3.2, MMCA Technical Committee, Jan. 2002.

“SanDisk Introduces the World’s Smallest-Removable Flash Card for Mobile Phones-The miniSD Card,” [www.sandisk.com/;pressrelease/031303\\_minisd.htm](http://www.sandisk.com/;pressrelease/031303_minisd.htm), Nov. 18, 2004.

Photograph of MiniSD, Japanese reference, Mar. 25, 2003.

Photograph of MiniSD Card, Mar. 25, 2003.

Photograph of MultiMedia Card, May 2000.

Photograph of SmartMedia Card, May 2000.

Photograph of SD Card, May 2001.

*Primary Examiner*—M. H. Tung

(74) *Attorney, Agent, or Firm*—Vierra Magen Marcus & DeNiro LLP

(57) **CLAIM**

The ornamental design for a memory card, as shown and described.

**DESCRIPTION**

FIG. 1 is a top perspective view of a memory card of the new design;

FIG. 2 is a bottom perspective view thereof;

FIG. 3 is a top view thereof;

FIG. 4 is a first side view thereof;

FIG. 5 is a second side view thereof;

FIG. 6 is a third side view thereof;

FIG. 7 is a bottom view thereof; and

FIG. 8 is a fourth side view thereof.

FIG. 9 is a top perspective view of a second embodiment thereof.

FIG. 10 is a bottom perspective view thereof;

FIG. 11 is a top view thereof;

FIG. 12 is a first side view thereof;

FIG. 13 is a second side view thereof;

FIG. 14 is a third side view thereof;

FIG. 15 is a bottom view thereof; and

FIG. 16 is a fourth side view thereof.

FIG. 17 is a top perspective view of a third embodiment thereof.

FIG. 18 is a bottom perspective view thereof;

FIG. 19 is a top view thereof;

FIG. 20 is a first side view thereof;

FIG. 21 is a second side view thereof;

FIG. 22 is a third side view thereof;

FIG. 23 is a bottom view thereof; and,

FIG. 24 is a fourth side view thereof.

The broken lines showing pins on the memory card are for illustrative purposes only and form no part of the claimed design.

**1 Claim, 3 Drawing Sheets**

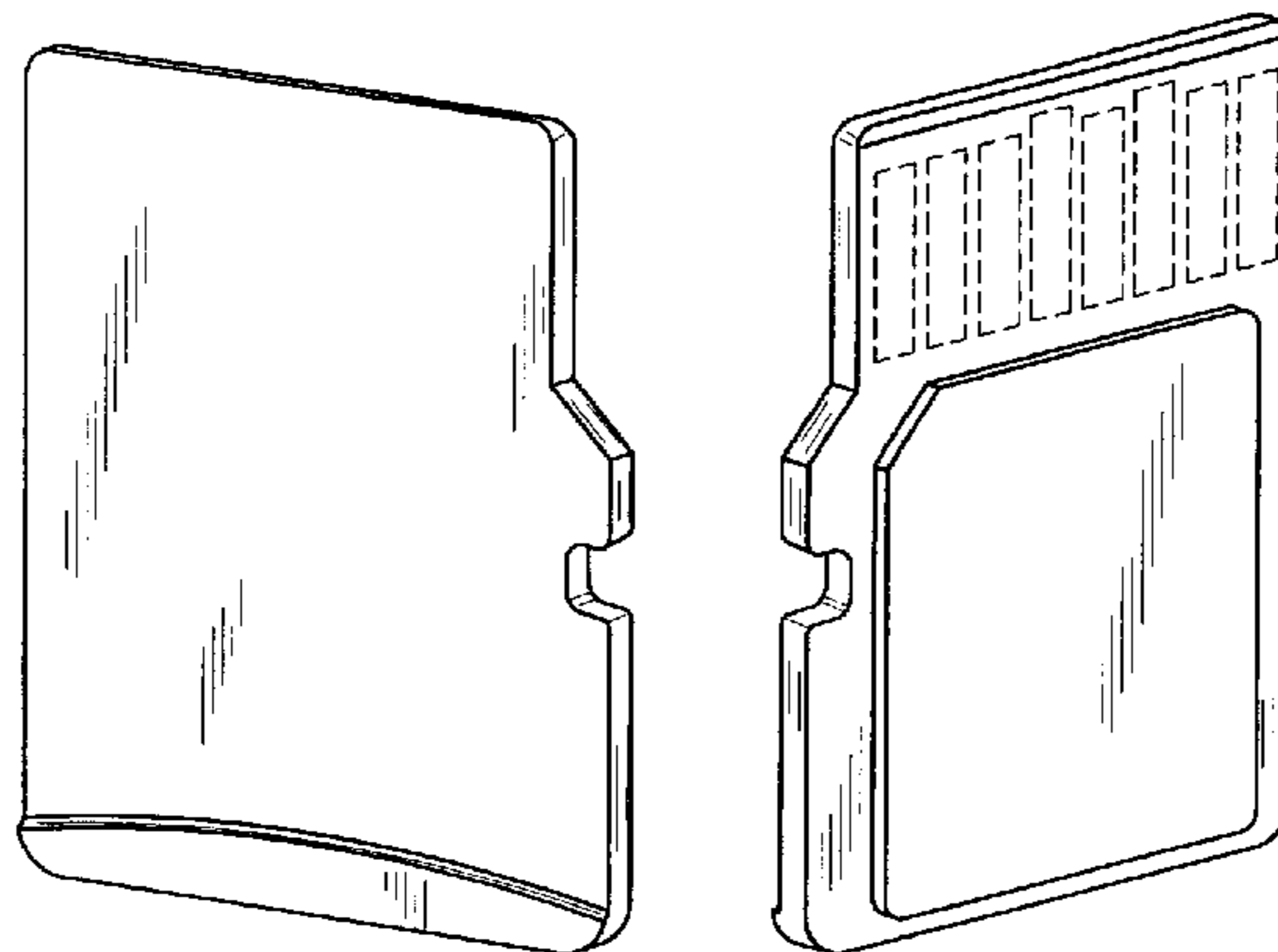

# US D523,435 S

## U.S. PATENT DOCUMENTS

D444,473 S	7/2001	Okamoto et al.	JP	D1092477 12/2000
D445,096 S	7/2001	Wallace	JP	D1092478 12/2000
D445,111 S	7/2001	Okamoto et al.	JP	D1095466 1/2001
D446,525 S	8/2001	Okamoto et al.	JP	D1100574 2/2001
D447,481 S	9/2001	Wallace et al.	JP	D1111788 6/2001
D452,243 S	12/2001	Wallace	JP	D1115151 7/2001
D452,244 S	12/2001	Wallace et al.	JP	D1126565 11/2001
D452,245 S	12/2001	Wallace et al.	JP	D1140248 4/2002
D452,246 S	12/2001	Wallace et al.	JP	D1140249 4/2002
D452,690 S	1/2002	Wallace et al.	JP	D1155269 10/2002
D452,864 S	1/2002	Wallace et al.	JP	D1174469 6/2003
D452,865 S	1/2002	Wallace et al.	JP	D1175213 6/2003
D453,515 S	2/2002	Brewer et al.	JP	D1177525 6/2003
D453,934 S	2/2002	Wallace et al.	JP	D1177757 6/2003
D457,887 S *	5/2002	Kadonaga ..... D14/436	JP	D1186655 10/2003
D459,355 S	6/2002	Shimoda et al.	JP	D1186656 10/2003
6,410,355 B1	6/2002	Wallace	JP	D1187137 10/2003
D460,456 S	7/2002	Shimoda et al.	JP	D1200593 3/2004
D467,586 S	12/2002	Shimoda et al.	JP	D1200640 3/2004
D487,747 S *	3/2004	Yu et al. .... D14/436	JP	D12100591 3/2004
D488,476 S *	4/2004	Yu et al. .... D14/436	JP	D1210422 6/2004
D488,477 S *	4/2004	Yu et al. .... D14/436	JP	D1210467 6/2004
D492,688 S *	7/2004	Wallace et al. .... D14/437	JP	D1210509 6/2004

## FOREIGN PATENT DOCUMENTS

JP	D1076070	6/2000	JP	D1210842 7/2004
JP	D1076071	6/2000	JP	D1210843 7/2004
JP	D1076072	6/2000	JP	D1210844 7/2004
JP	D1076730	6/2000	JP	D1210917 7/2004
JP	D1076731	6/2000	JP	D1210918 7/2004
JP	D1076732	6/2000	JP	D1211213 7/2004
JP	D1076733	6/2000	JP	D1211215 7/2004
JP	D1086348	9/2000	JP	D1211372 7/2004
JP	D1089092	10/2000	JP	D1212214 7/2004
JP	D1089310	10/2000	JP	D1212647 7/2004
JP	D1092476	12/2000	JP	D1212850 7/2004
			JP	D1212851 7/2004

\* cited by examiner

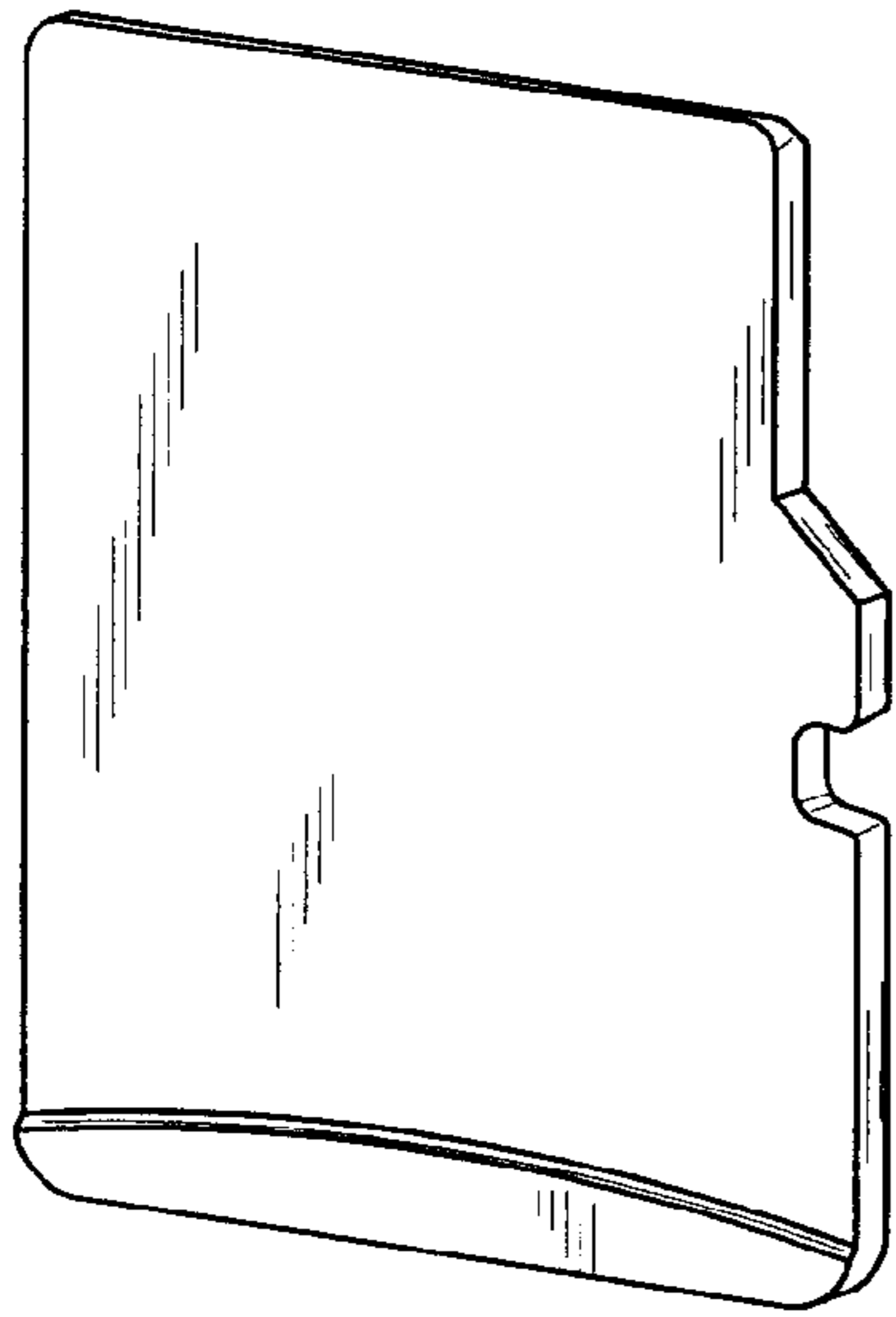

FIG. 1

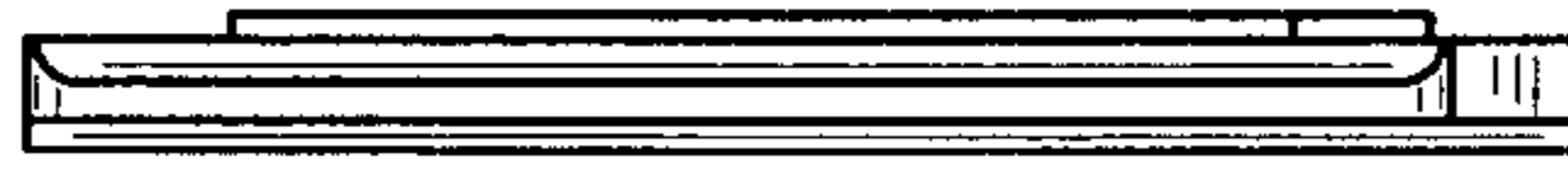

FIG. 5



FIG. 3



FIG. 4

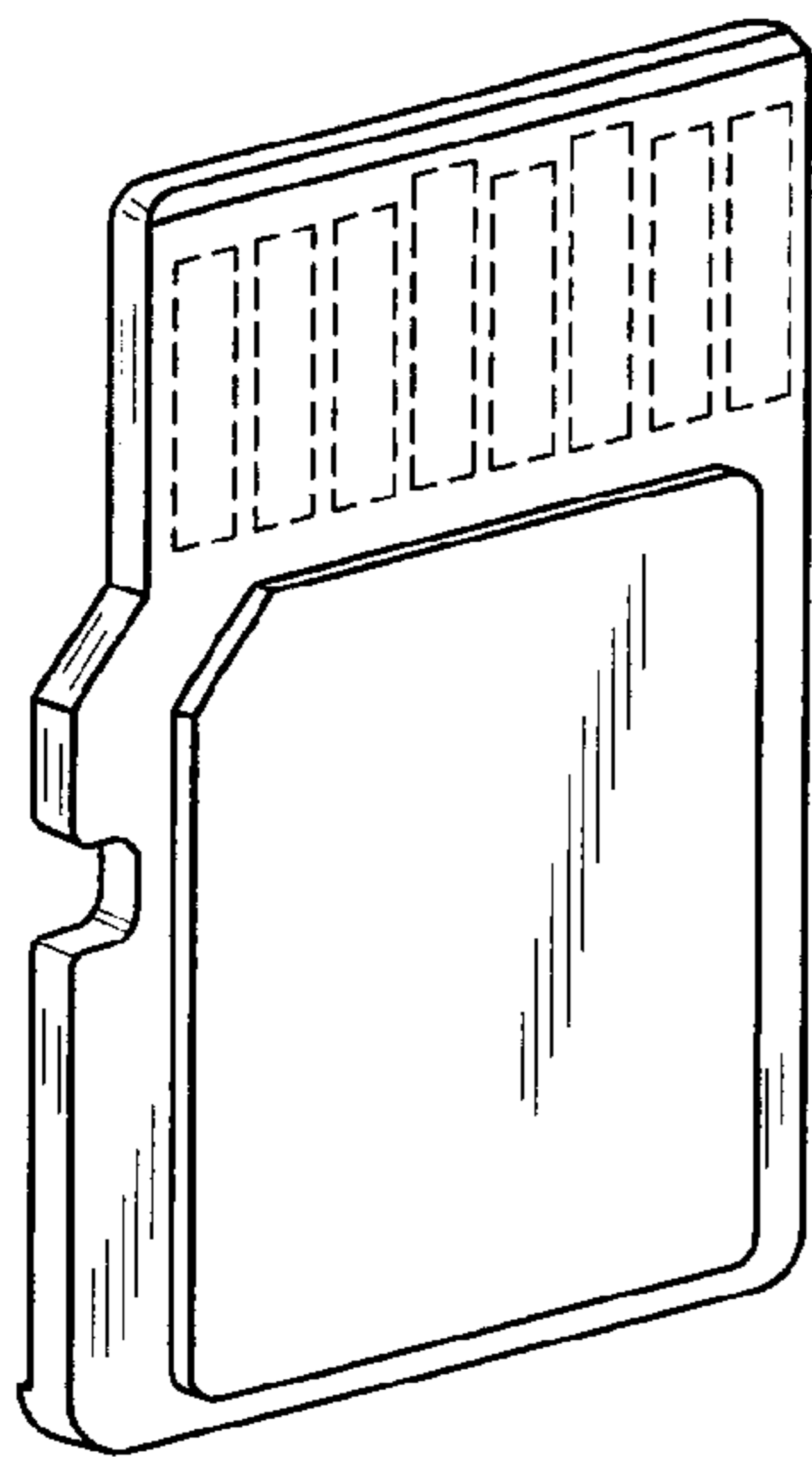

FIG. 2



FIG. 6

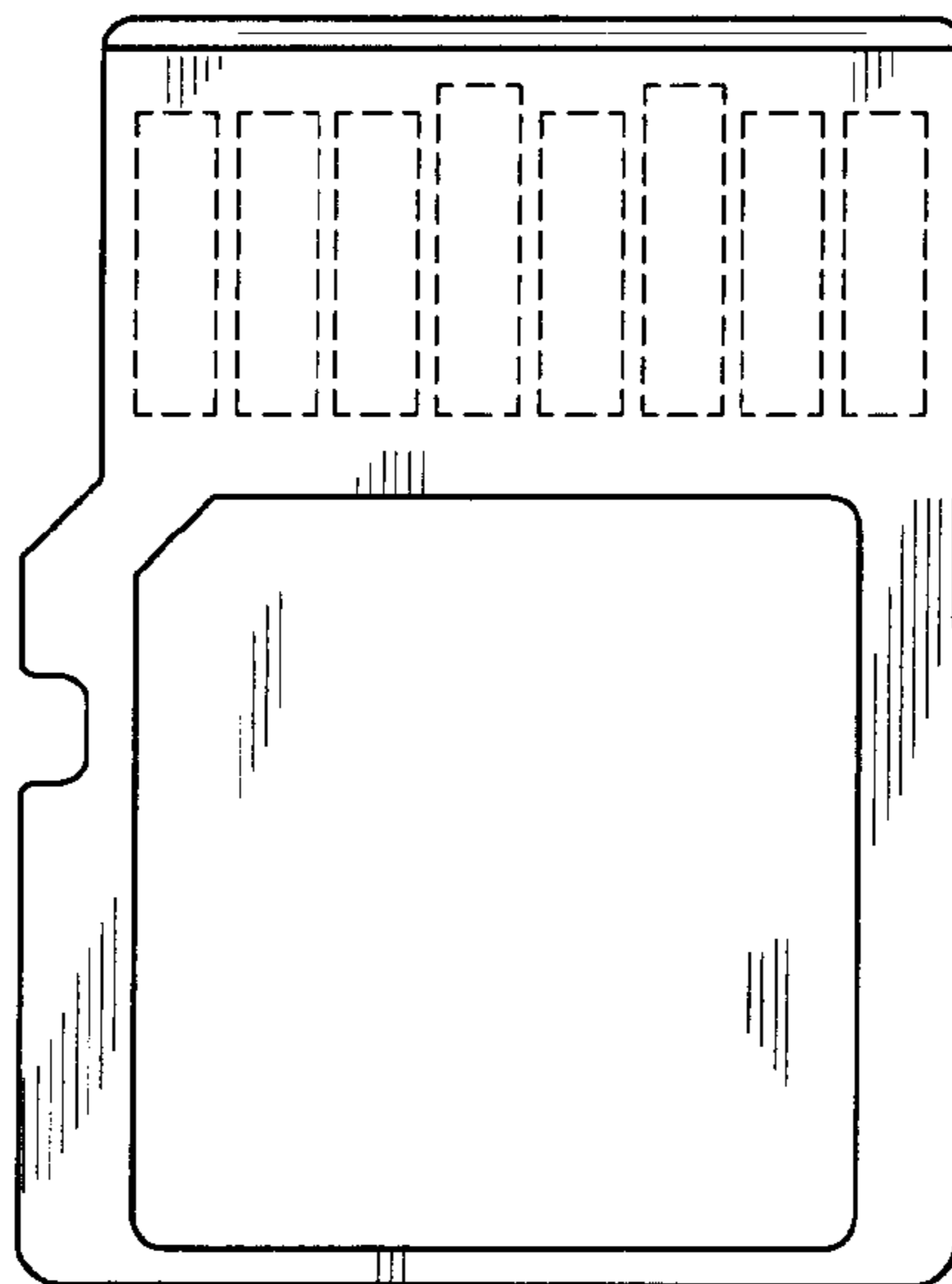

FIG. 7



FIG. 8

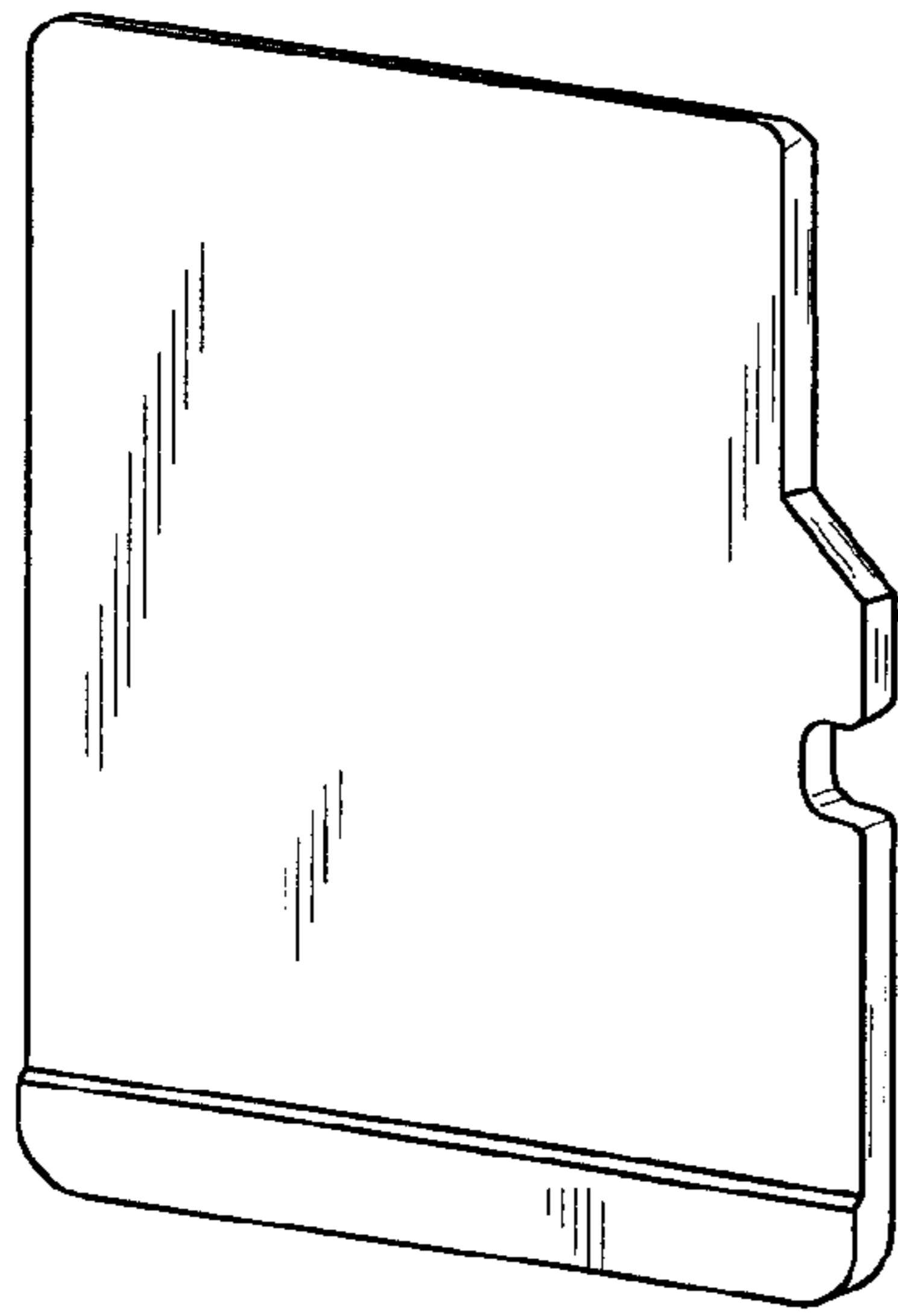

FIG. 9

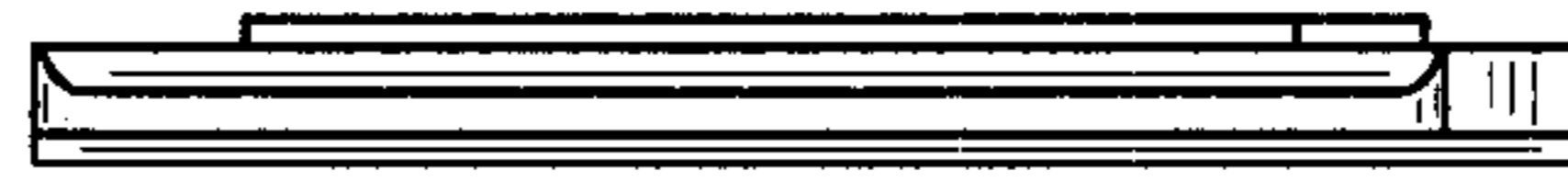

FIG. 13

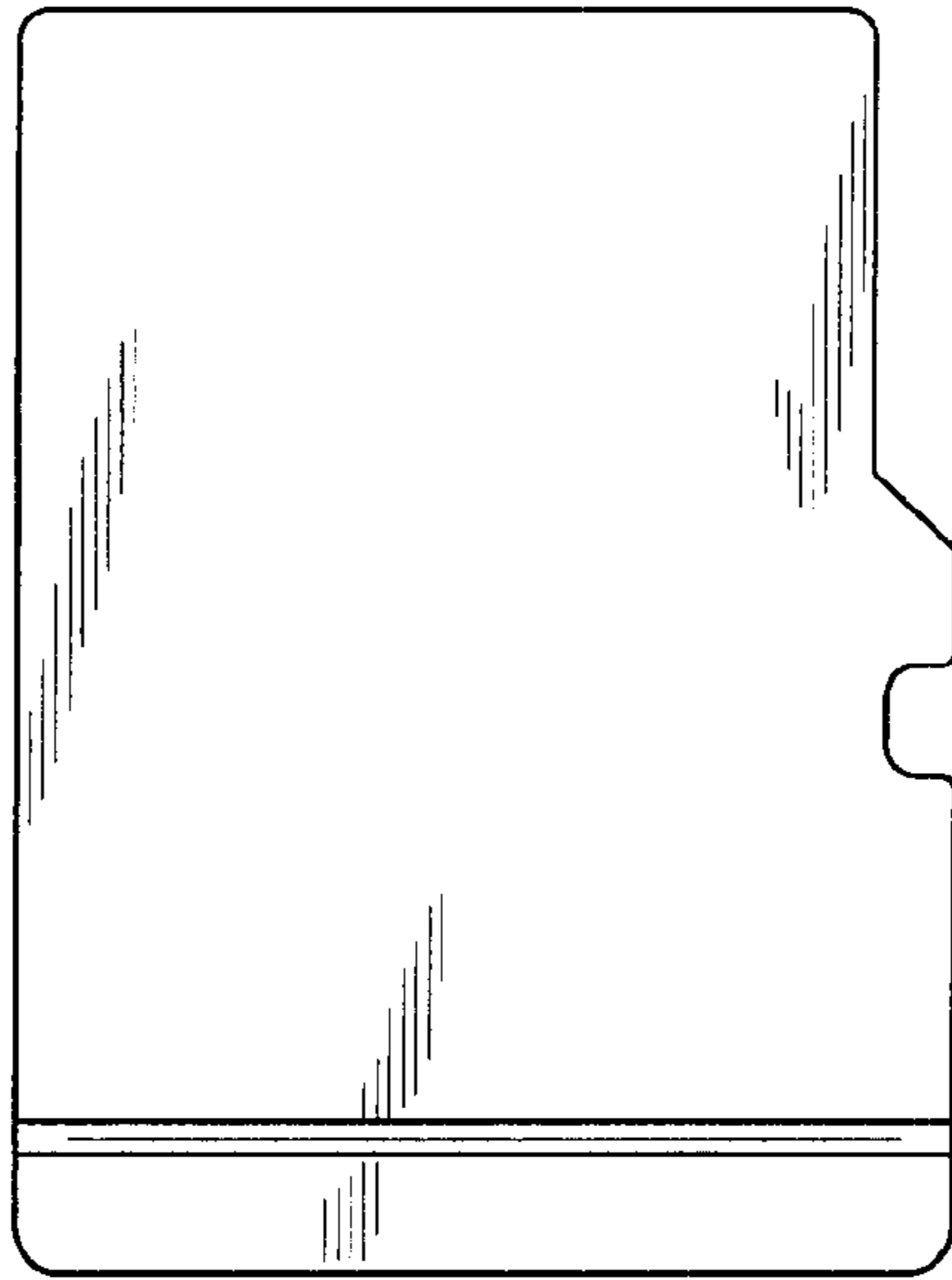

FIG. 11



FIG. 12

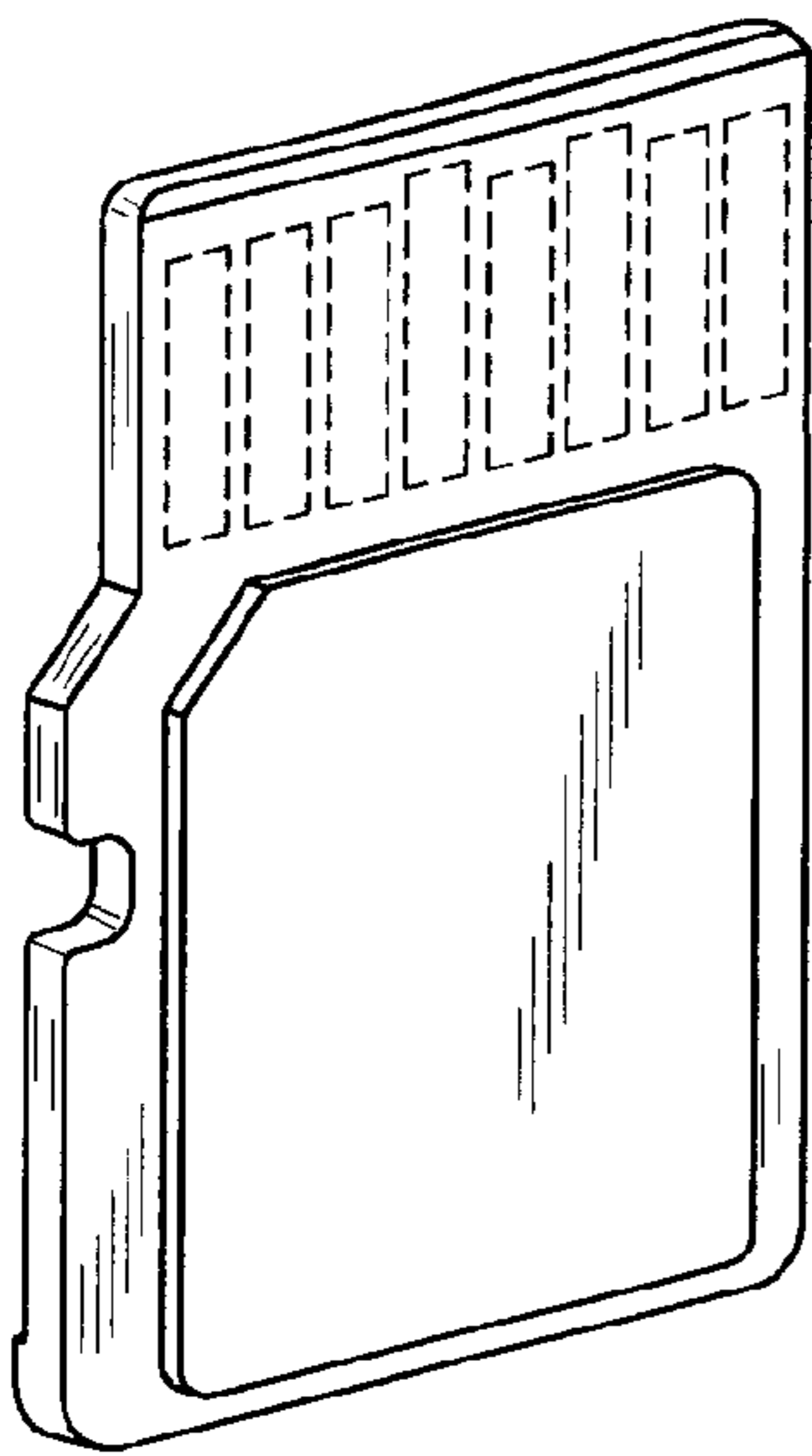

FIG. 10

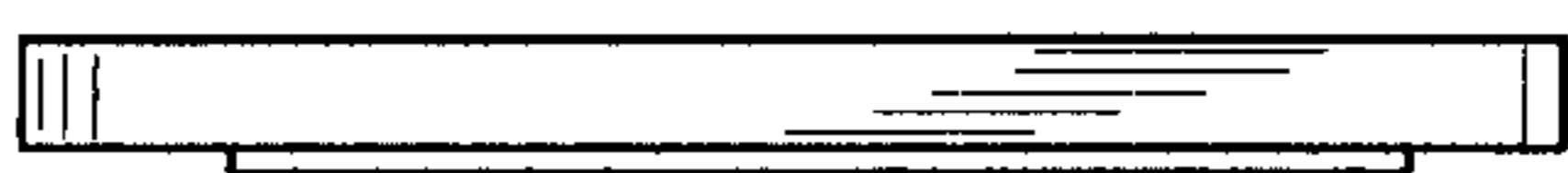

FIG. 14

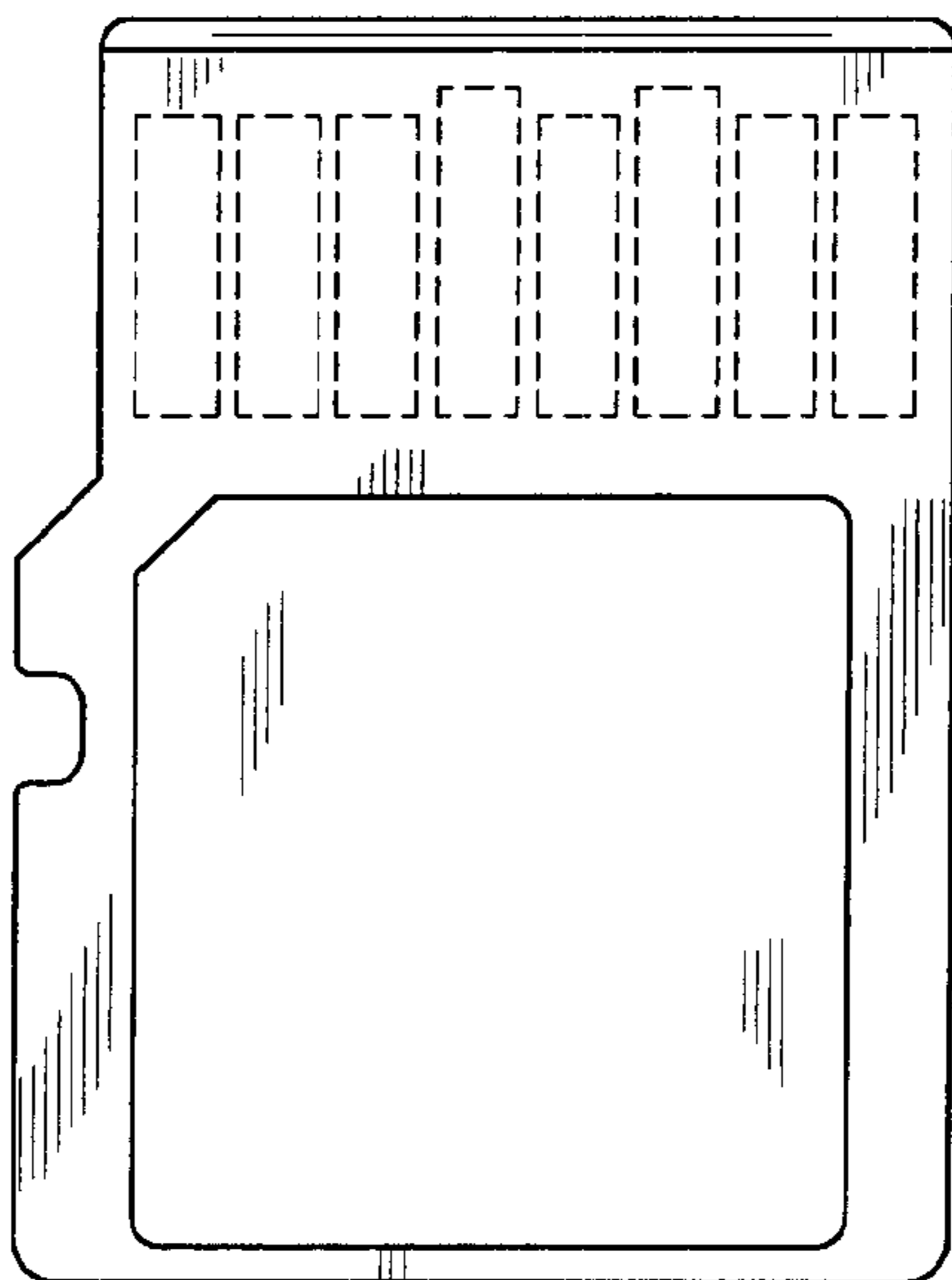

FIG. 15



FIG. 16

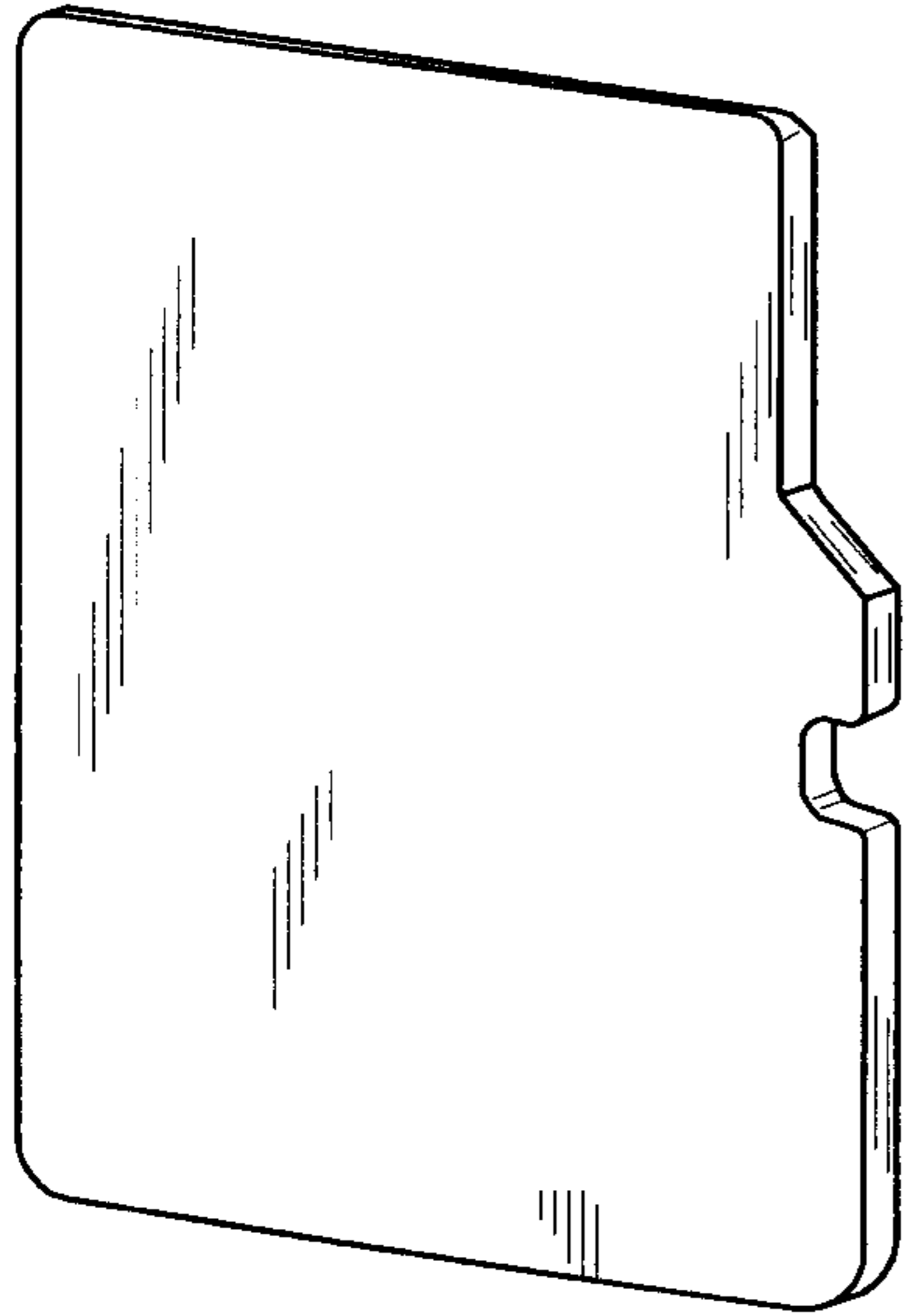

FIG. 17

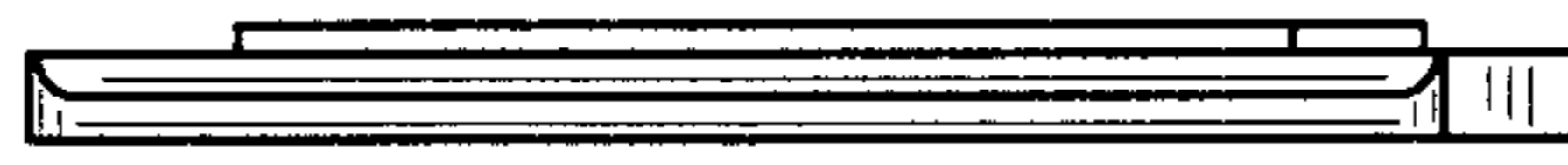

FIG. 21

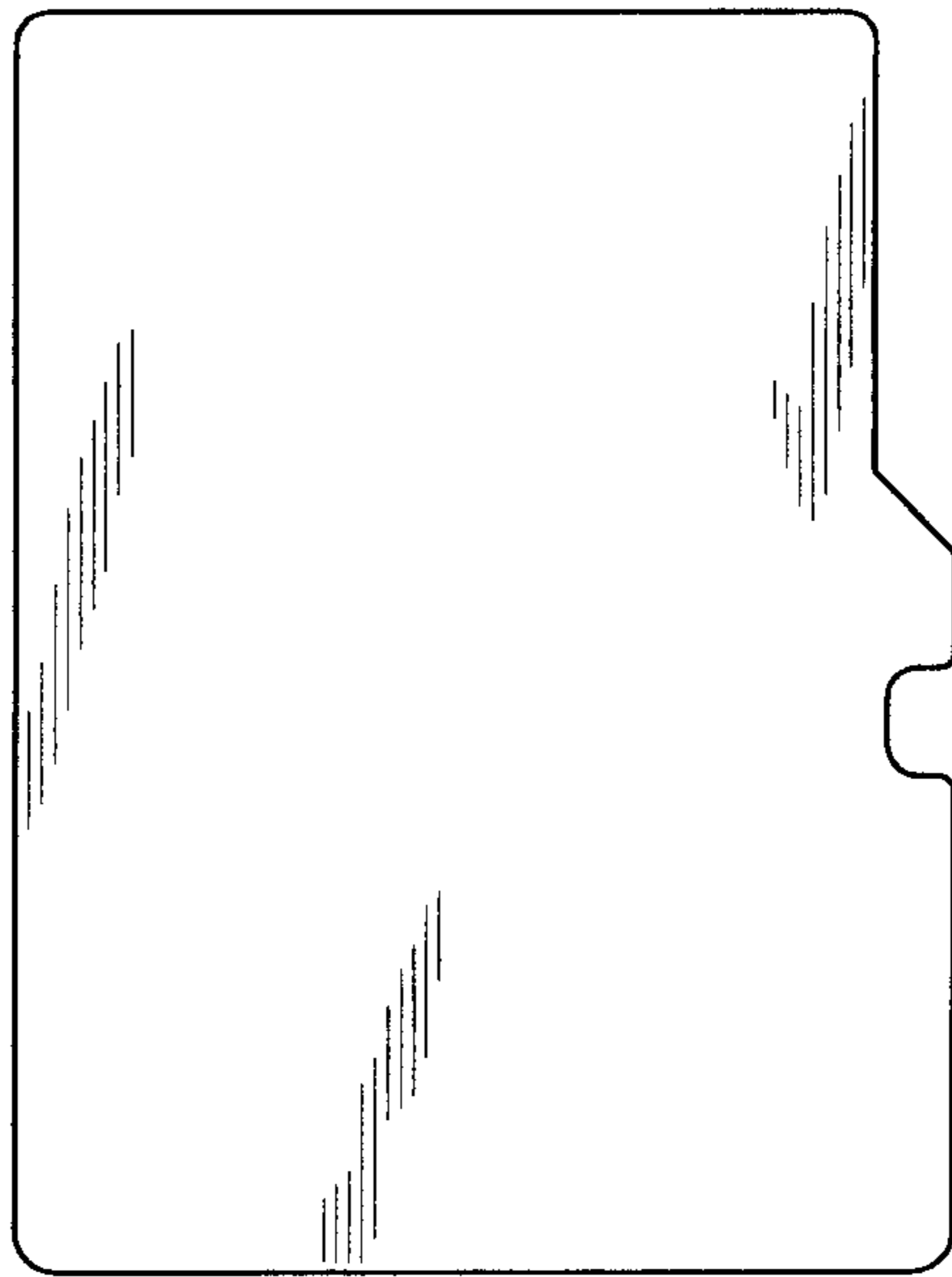

FIG. 19



FIG. 20



FIG. 22

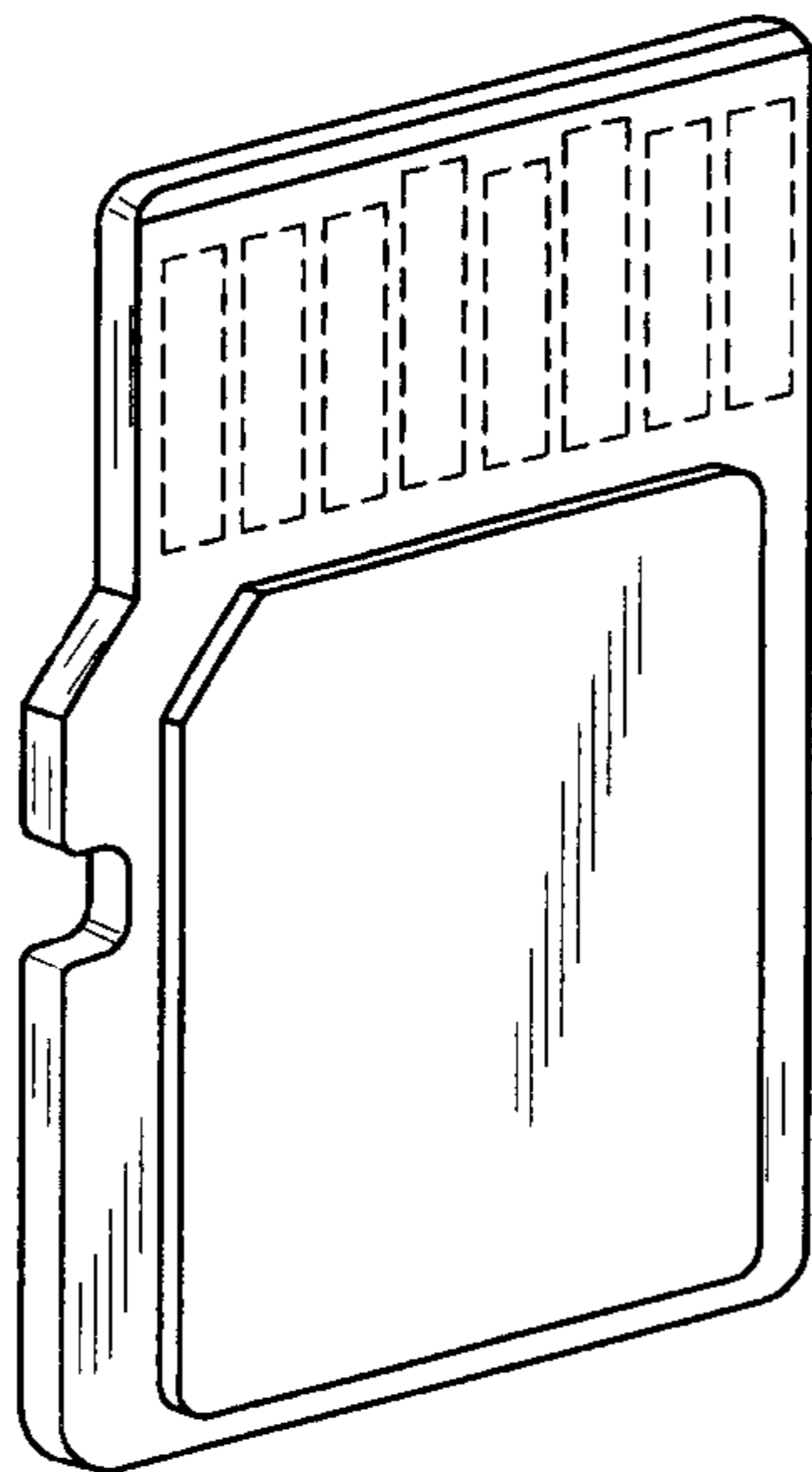

FIG. 18

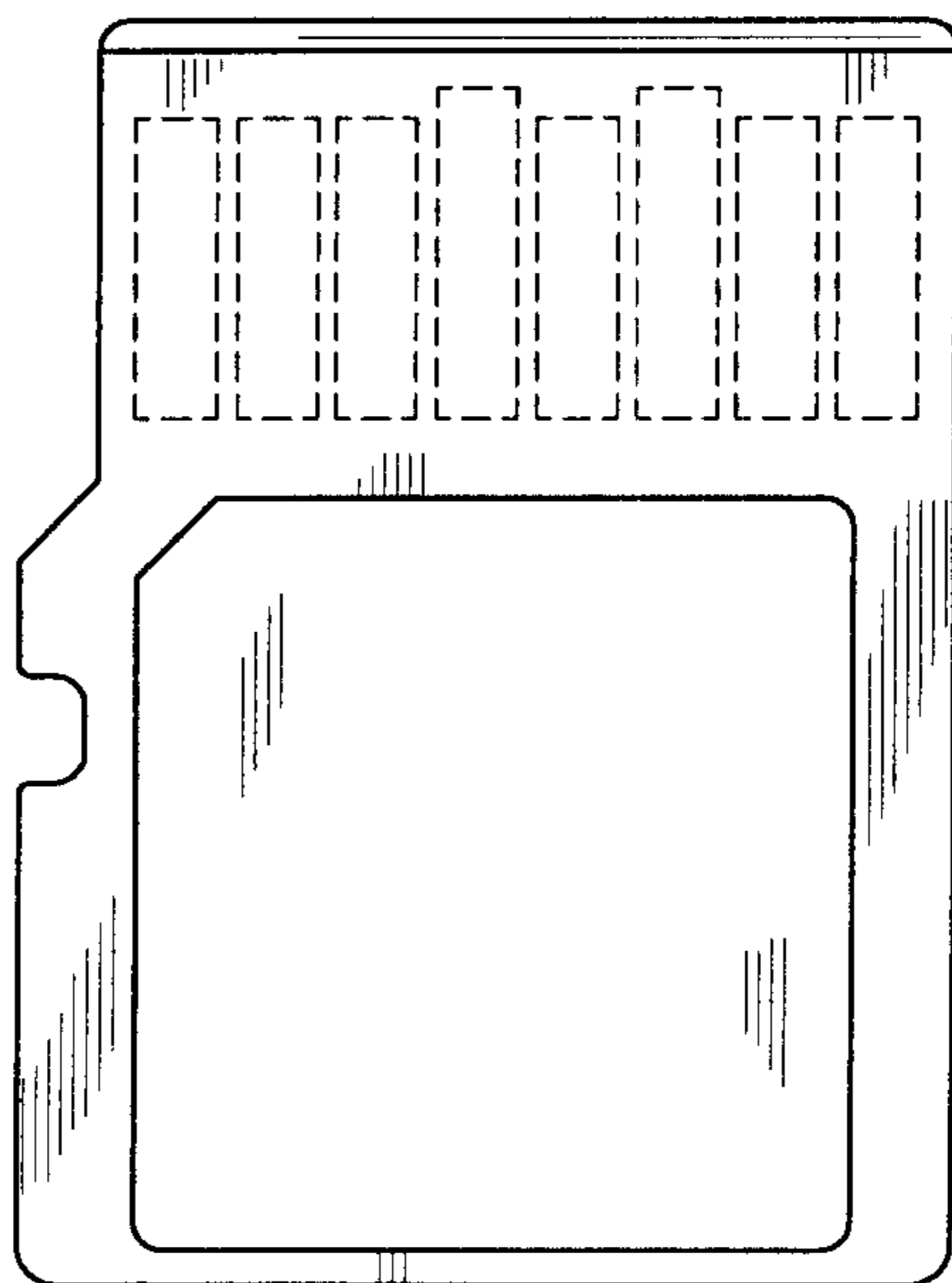

FIG. 23



FIG. 24