

US00D523374S

(12) **United States Design Patent**
Raid et al.

(10) **Patent No.:** **US D523,374 S**
(45) **Date of Patent:** **** Jun. 20, 2006**

(54) **PASSION CROSS**

(76) Inventors: **Shech Yosef Raid**, Post No. 1856, 1 Street, No. 20, Taibe (IL), 40400;
Mordechai Gafni, Post No. 1856, 1 Street, No. 20, Tiberias (IL), 40400;
Avner Zilberman, 21 Harechasim Street, Ramat-Gan (IL), 52355

(**) Term: **14 Years**

(21) Appl. No.: **29/225,609**

(22) Filed: **Mar. 18, 2005**

(51) **LOC (8) Cl.** **02-01**

(52) **U.S. Cl.** **D11/96**

(58) **Field of Classification Search** D11/1-2,
D11/7, 40-44, 46-49, 53, 56-57, 59-61,
D11/63, 65, 79-83, 86-87, 89-90, 99, 91-92,
D11/101, 106, 114-116, 200-201; 63/1.11,
63/18-20; D3/207-211
See application file for complete search history.

(56) **References Cited**

U.S. PATENT DOCUMENTS

D26,013 S	*	9/1896	Dutemple	D11/97
D119,993 S		4/1940	Brandt et al.		
D224,914 S		10/1972	David	D45/16
D226,624 S		4/1973	Maze	D45/16 B
D236,019 S		7/1975	Scott	D45/16 B
D408,318 S		4/1999	Zuzul	D11/96
D485,206 S	*	1/2004	Pachachi	D11/96
D500,261 S		12/2004	Pachachi	D11/96

* cited by examiner

Primary Examiner—Ralf Seifert

(74) *Attorney, Agent, or Firm*—Sullivan & Worcestor LLP

(57) **CLAIM**

The ornamental design for a passion cross, as shown and described.

DESCRIPTION

FIG. 1 is a perspective view of an embodiment of a passion cross.

FIG. 2 is a top view of the embodiment of FIG. 1.

FIG. 3 is a first side of the embodiment of FIG. 1.

FIG. 4 is a second side view of the embodiment of FIG. 1.

FIG. 5 is a third side view of the embodiment of FIG. 1.

FIG. 6 is a bottom view of the embodiment of FIG. 1.

FIG. 7 is a top view of the vertical member of the embodiment of FIG. 1.

FIG. 8 is a perspective view of the vertical member of the embodiment of FIG. 1.

FIG. 9 is a first side view of the vertical member of the embodiment of FIG. 1.

FIG. 10 is a second side of the vertical member of the embodiment of FIG. 1.

FIG. 11 is a bottom view of the vertical member of the embodiment of FIG. 1.

FIG. 12 is a top view of one of the horizontal members of the embodiment of FIG. 1.

FIG. 13 is a perspective view of one of the horizontal members of the embodiment of FIG. 1.

FIG. 14 is a first side view of one of the horizontal members of the embodiment of FIG. 1.

FIG. 15 is a second side view of one of the horizontal members of the embodiment of FIG. 1; and,

FIG. 16 is a bottom view of one of the horizontal members of the embodiment of FIG. 1.

1 Claim, 2 Drawing Sheets

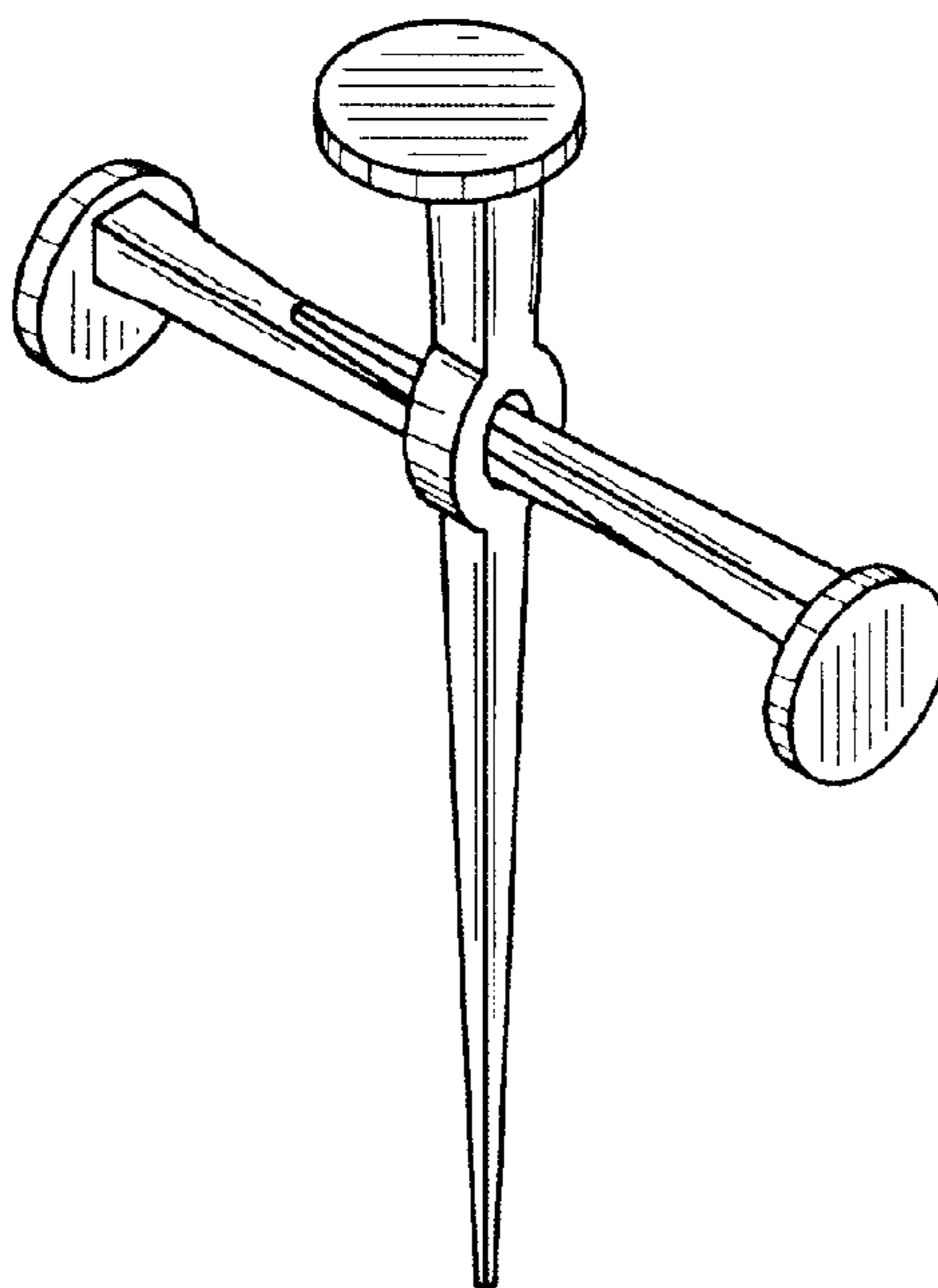

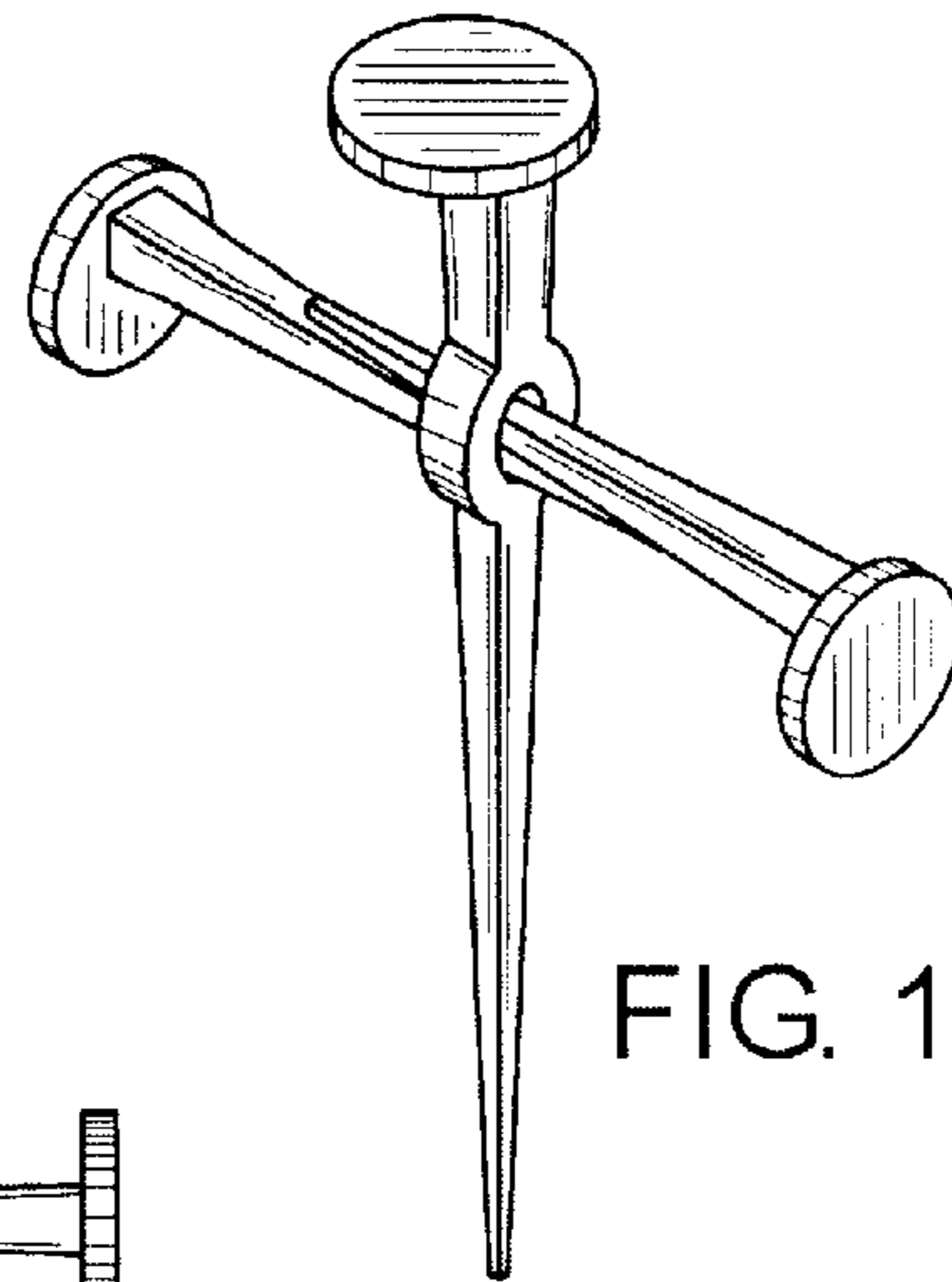

FIG. 1

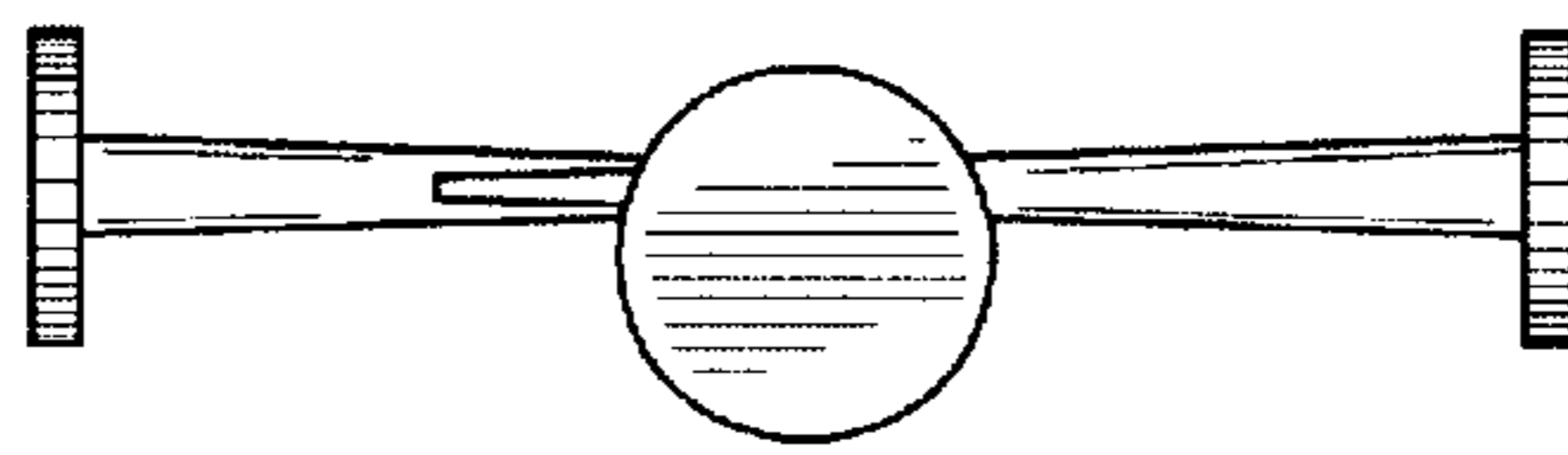

FIG. 2

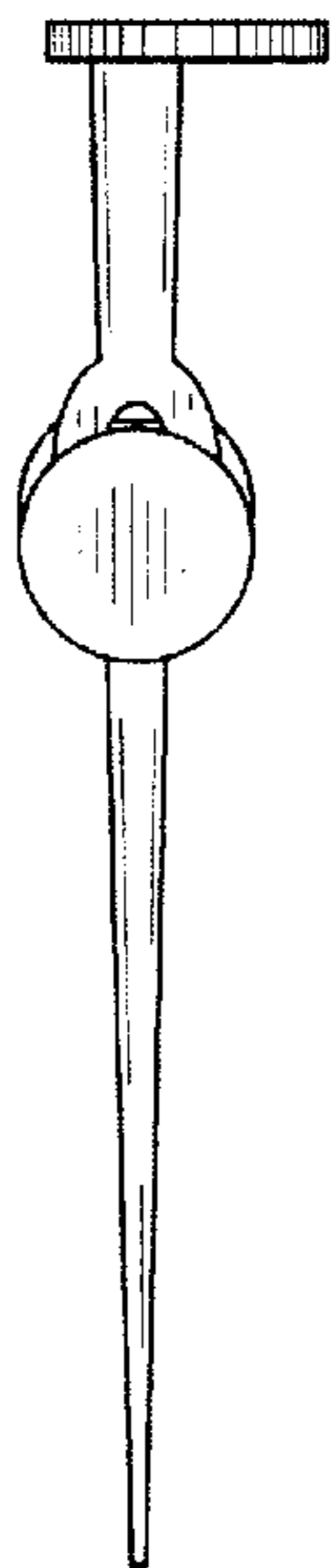

FIG. 3

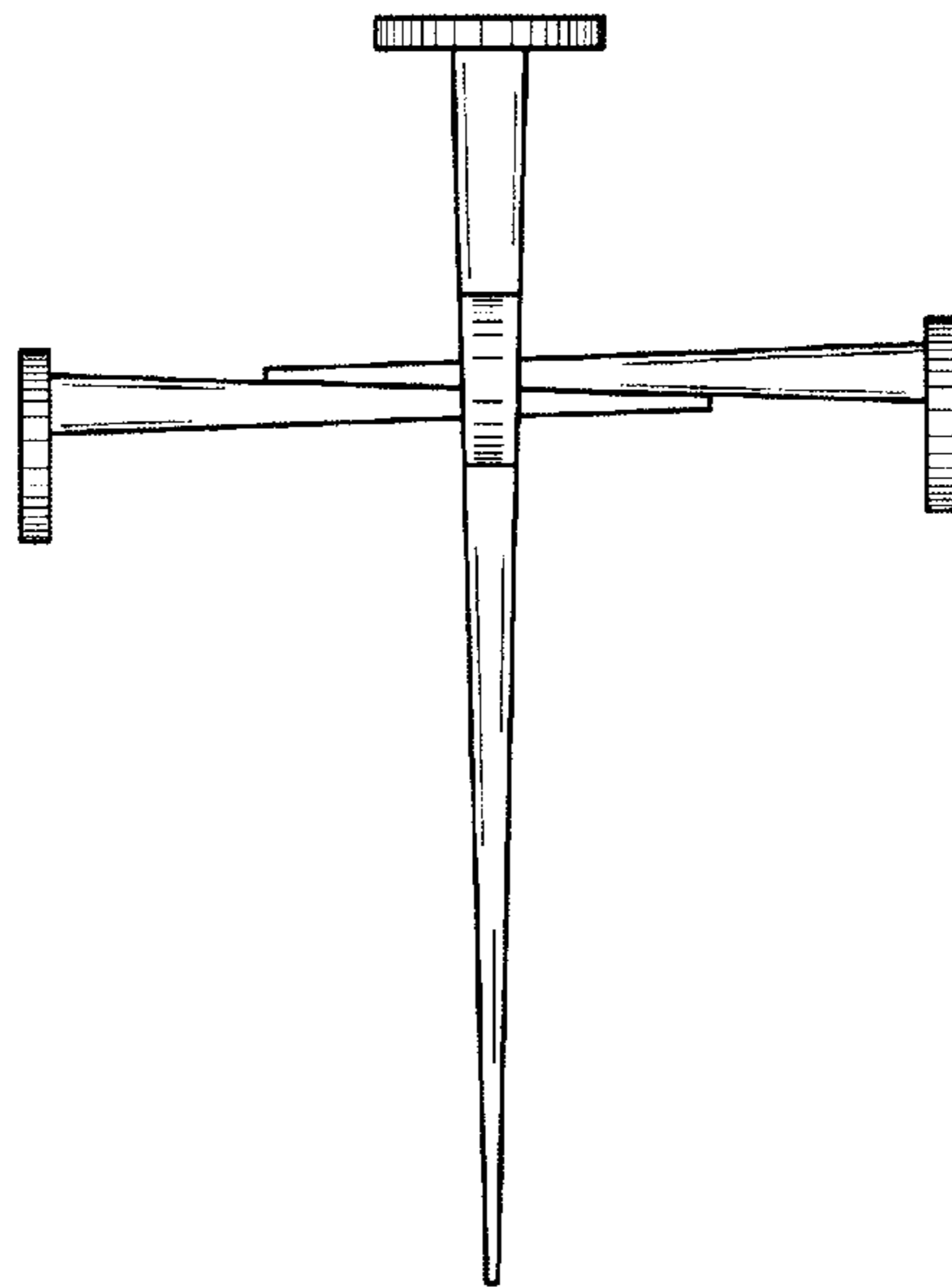

FIG. 4

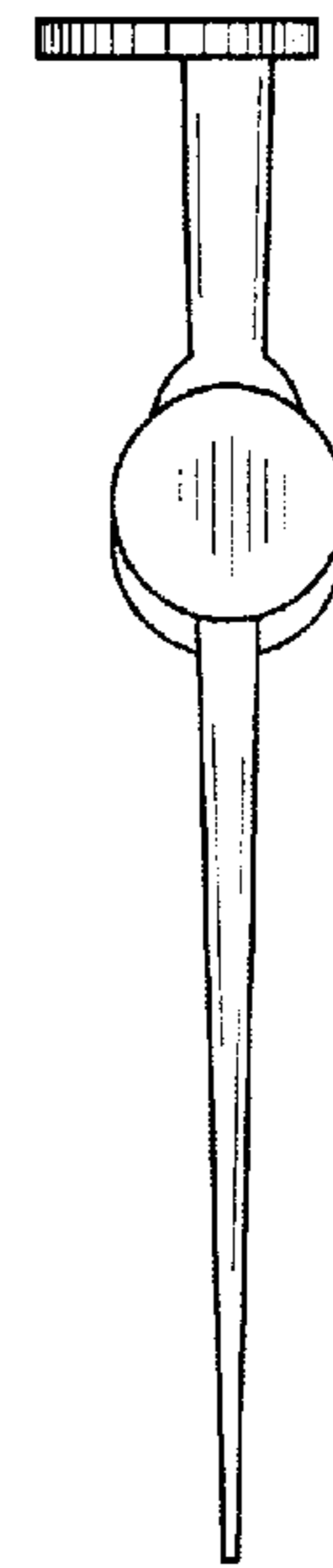

FIG. 5

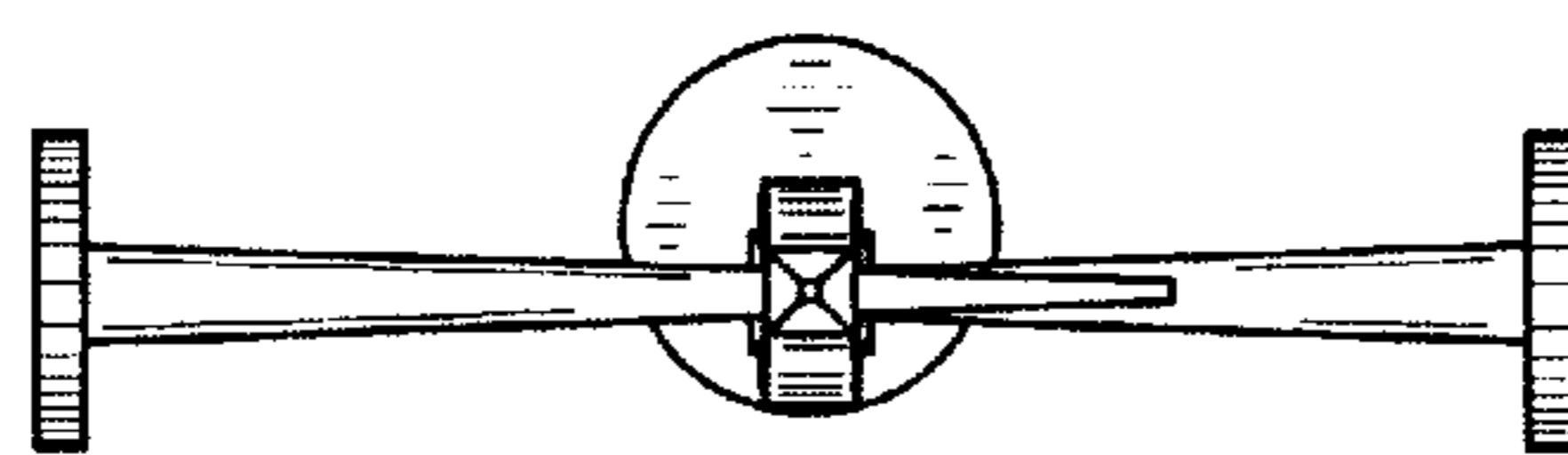

FIG. 6

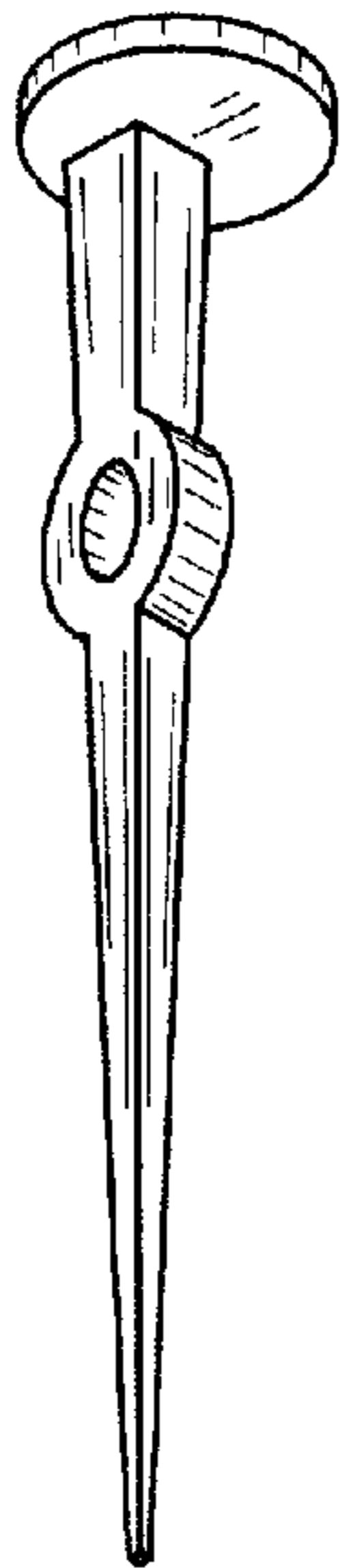
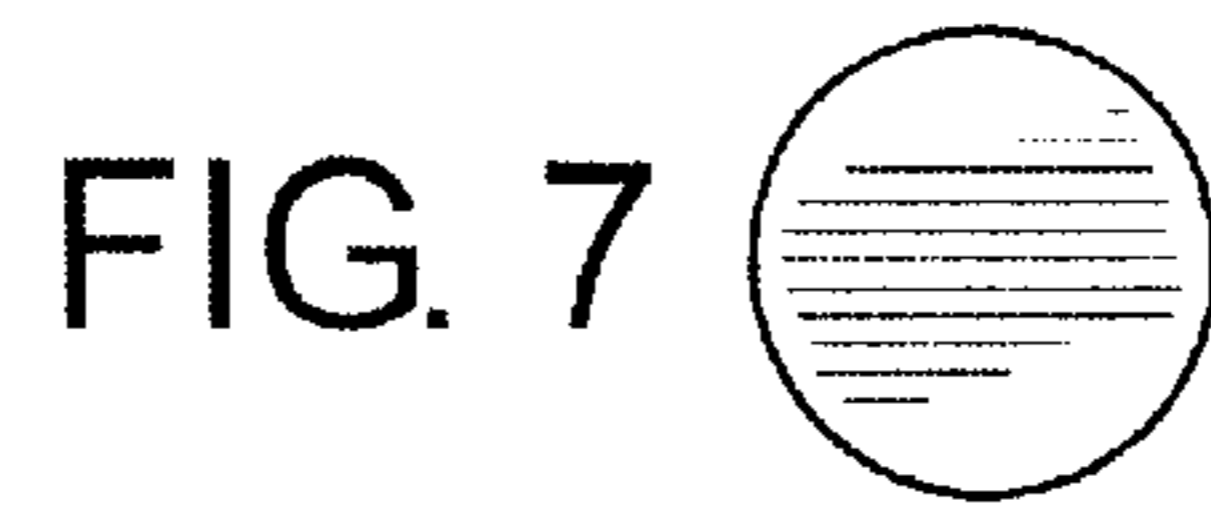

FIG. 8

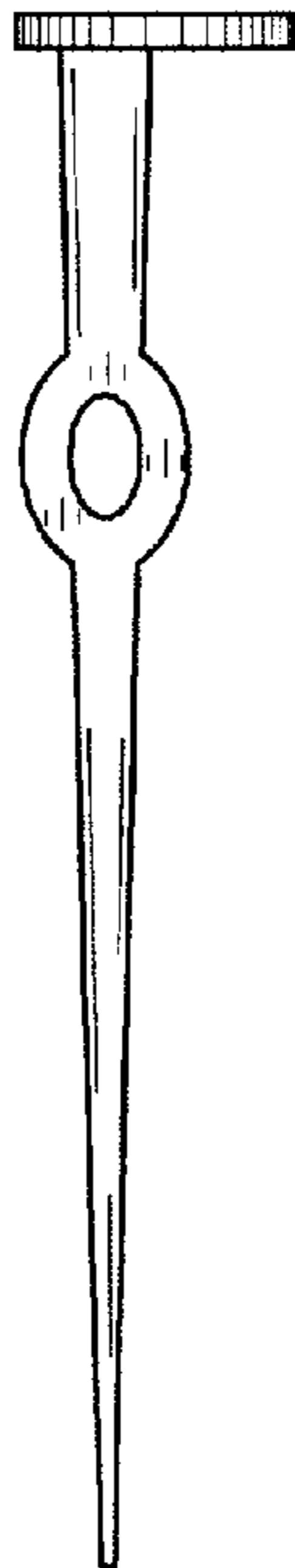

FIG. 9

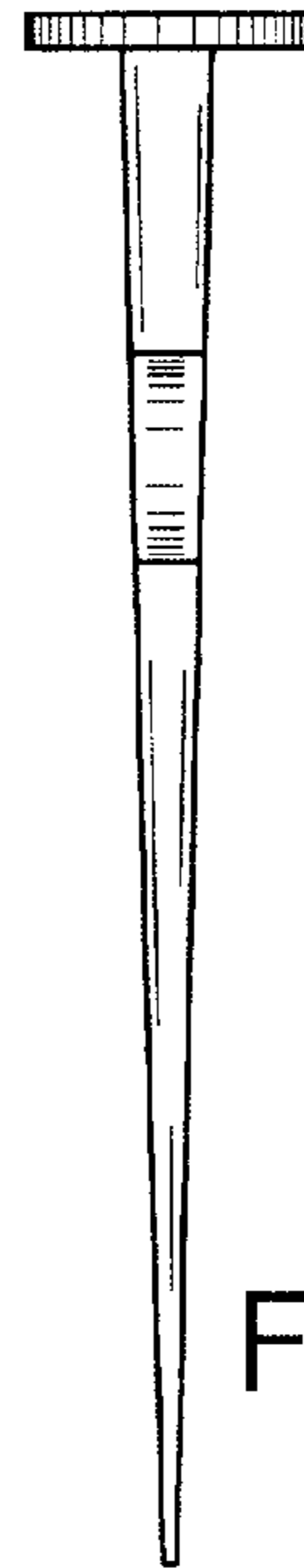

FIG. 10

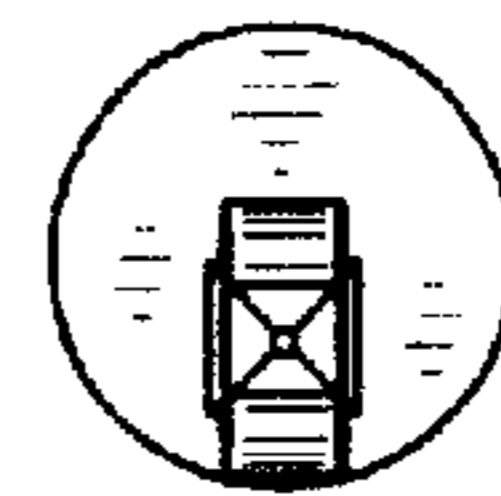

FIG. 11

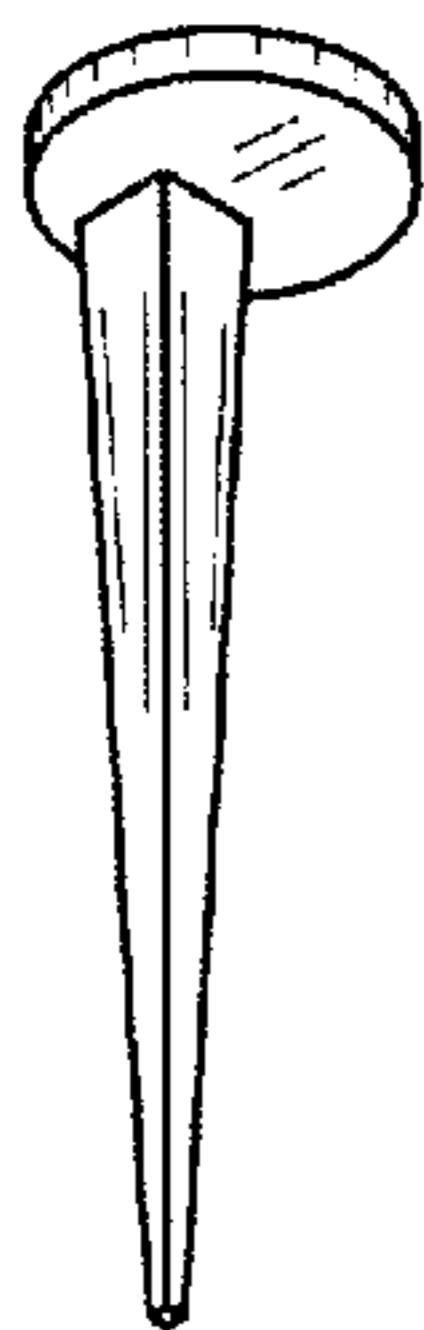
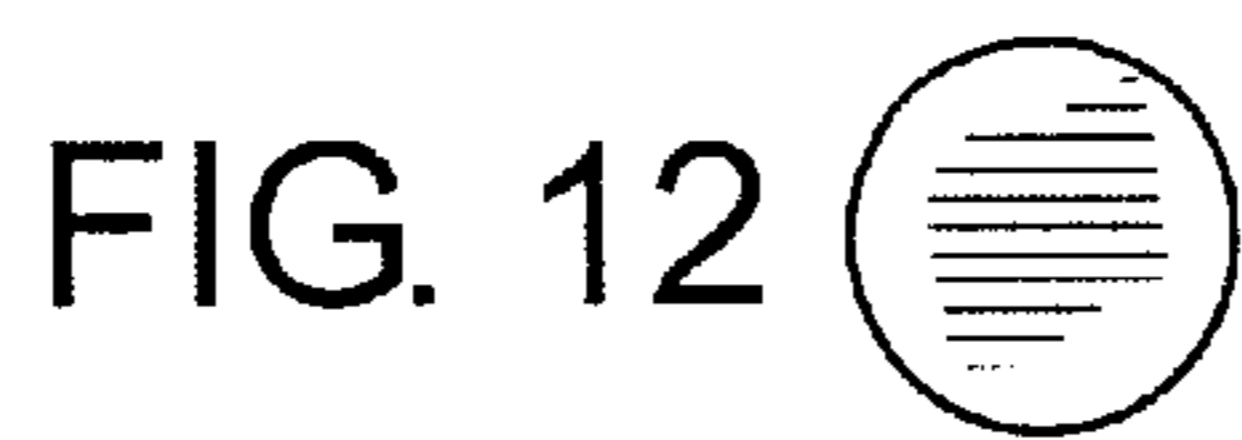

FIG. 13

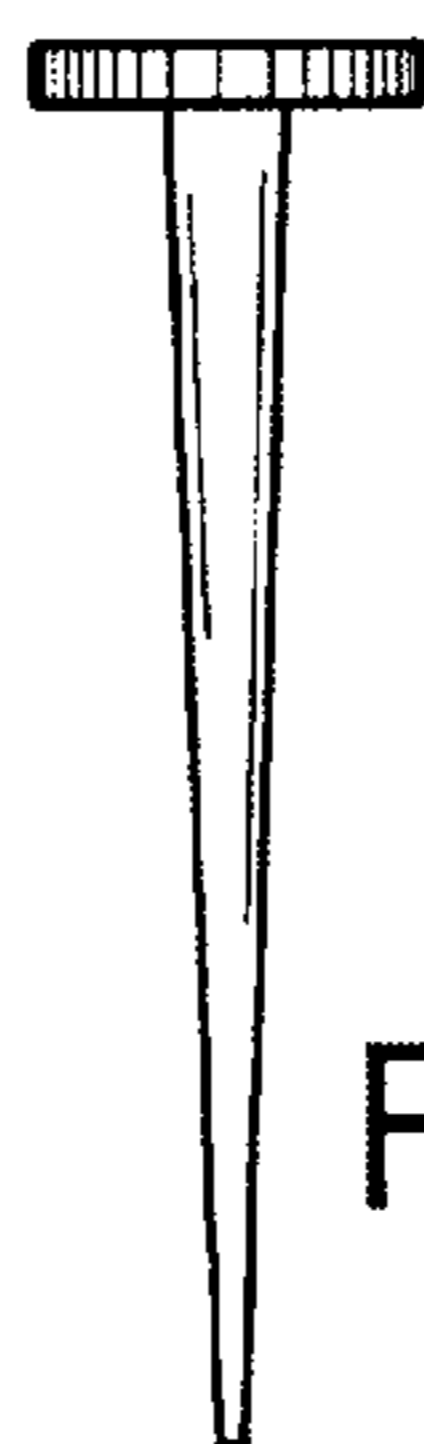

FIG. 14



FIG. 15



FIG. 16