

US00D523267S

(12) **United States Design Patent**
Mays-Hobbs

(10) **Patent No.:** **US D523,267 S**

(45) **Date of Patent:** **** Jun. 20, 2006**

(54) **TRASH BAG DISPENSER**

D392,482 S * 3/1998 Seenath D6/515
D427,825 S 7/2000 Mooney

(76) Inventor: **Jacqueline Mays-Hobbs**, 1304 Martin Luther King South, Bastrop, LA (US) 71220

* cited by examiner

Primary Examiner—Brian N Vinson

(**) Term: **14 Years**

(74) *Attorney, Agent, or Firm*—Crossley Patent Law; Mark A. Crossley

(21) Appl. No.: **29/223,452**

(57) **CLAIM**

(22) Filed: **Feb. 15, 2005**

The ornamental design for a trash bag dispenser, as shown and described.

(51) **LOC (8) Cl.** **20-02**

(52) **U.S. Cl.** **D6/518**

(58) **Field of Classification Search** D6/515–523; 206/225, 233, 389, 391, 812, 824; 211/13.1, 211/45; 222/173, 180; 221/26, 33, 282–283; 224/925; 242/570, 590; 248/309.1, 309.2, 248/905; D12/17, 19

DESCRIPTION

See application file for complete search history.

FIG. 1 is a front elevation view of a trash bag dispenser showing my new design;
FIG. 2 is a rear elevation view of my invention;
FIG. 3 is a left side elevation view;
FIG. 4 is a right side elevation view with the side cover partially removed for clarity;
FIG. 5 is a top plan view;
FIG. 6 is a bottom plan view; and,
FIG. 7 is a left side isometric view of a trash bag dispenser showing my new design.

(56) **References Cited**

U.S. PATENT DOCUMENTS

D195,140 S * 4/1963 Johnson D6/520
D201,912 S * 8/1965 Simpkins D6/520
D219,168 S * 11/1970 Chase et al. D6/520
5,657,900 A 8/1997 Scherr

The broken lines of an exemplary trash bag are for illustrative purposes only and form no part of the claimed design.

1 Claim, 3 Drawing Sheets

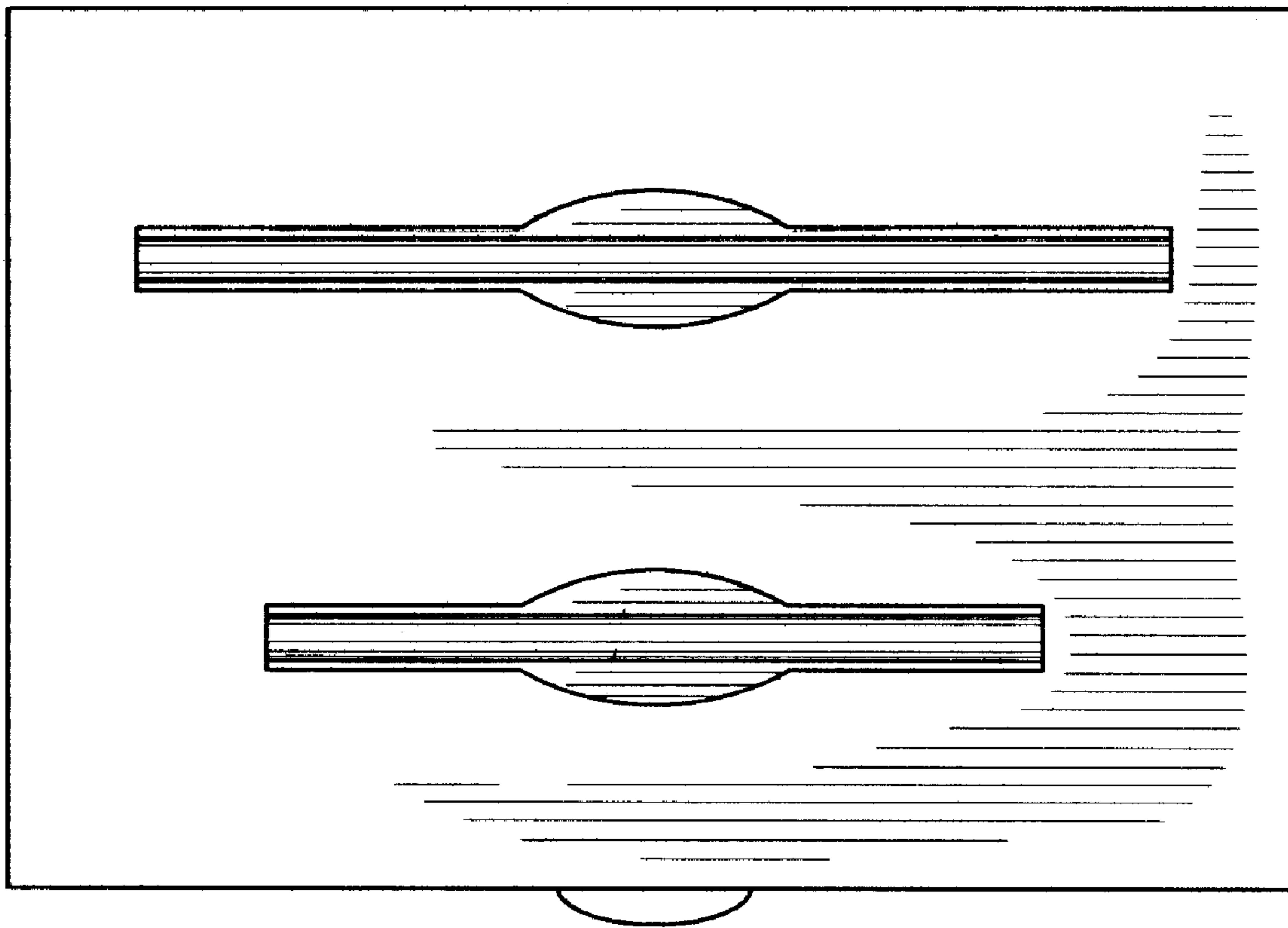

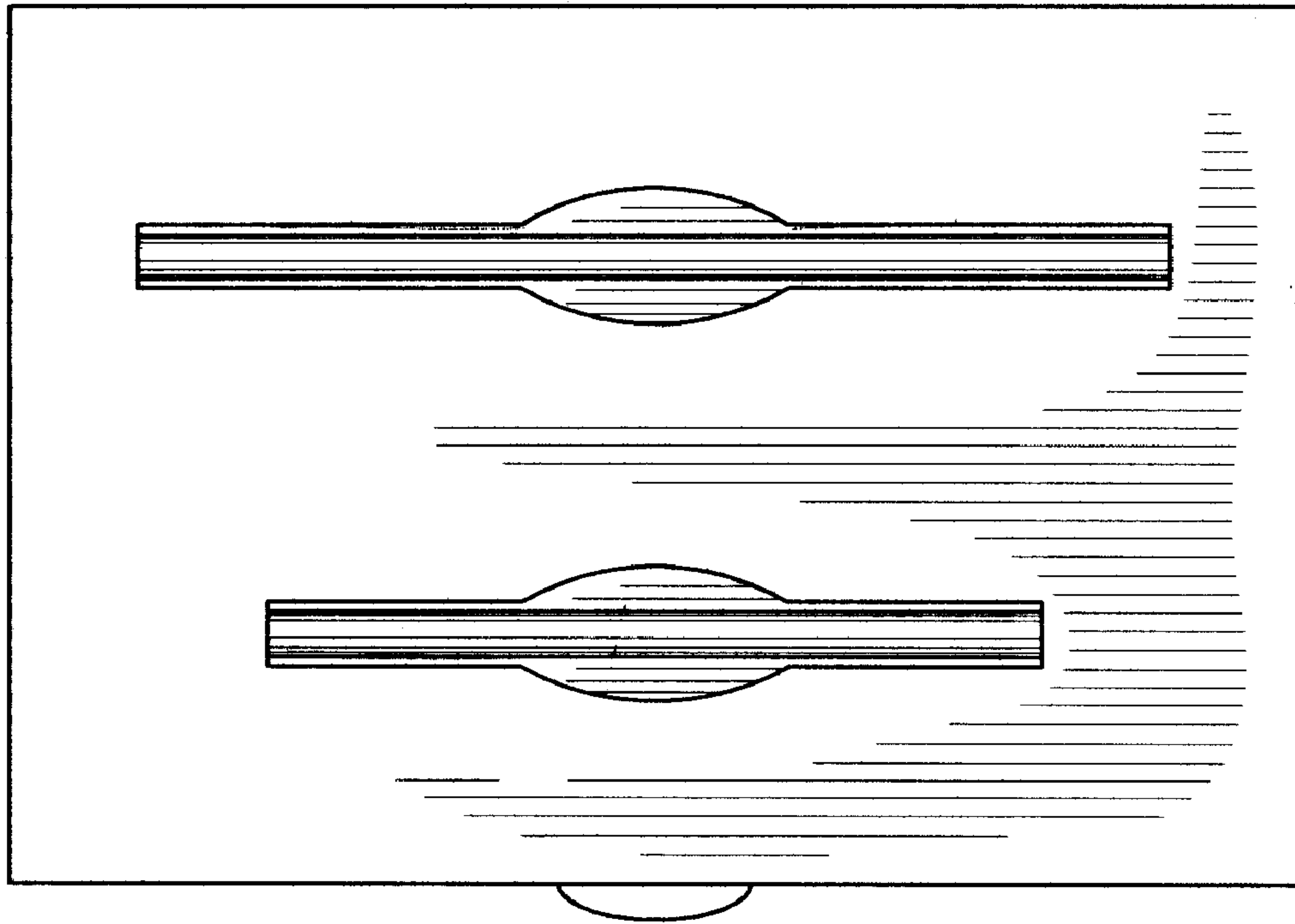

FIG. 1

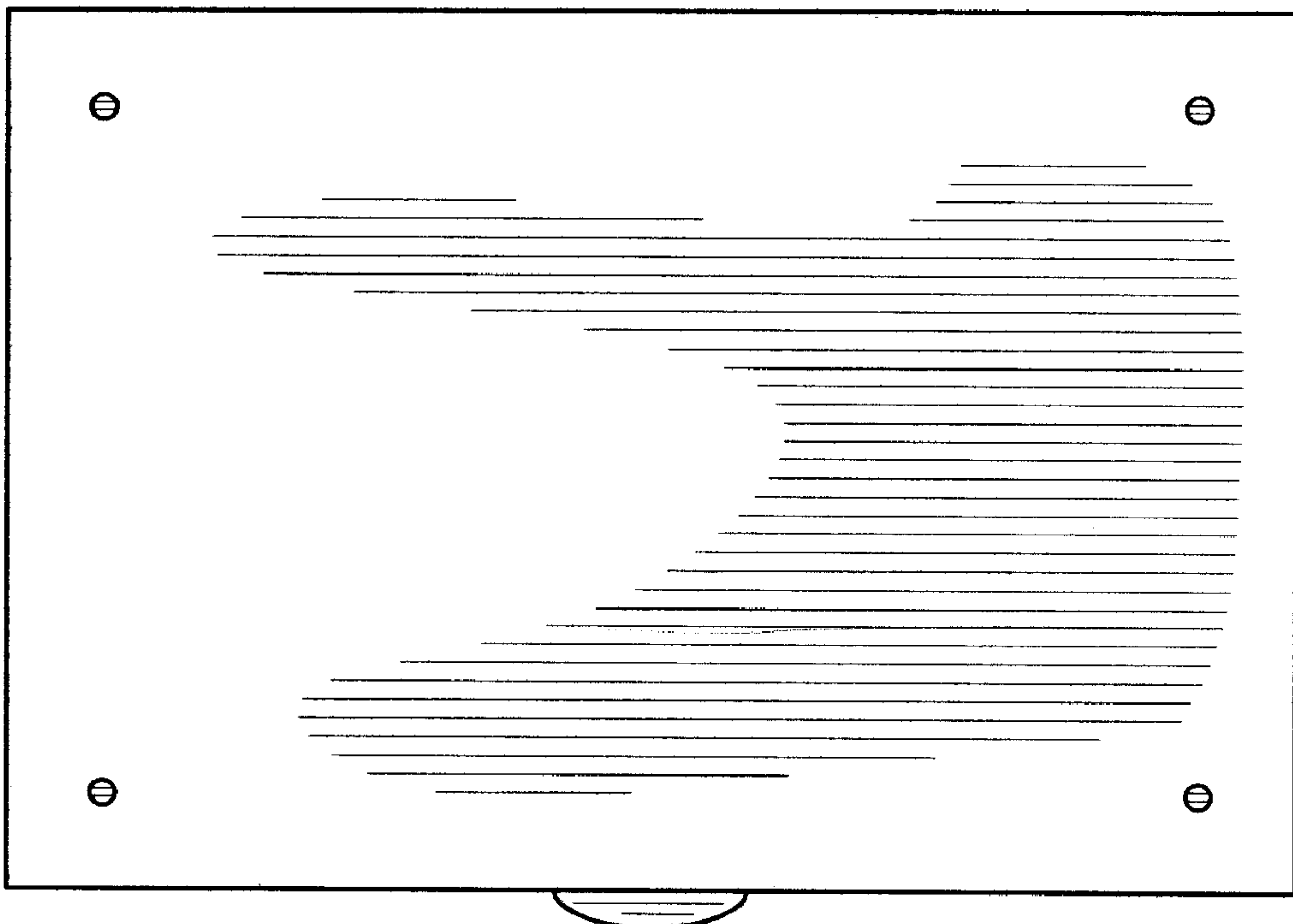

FIG. 2

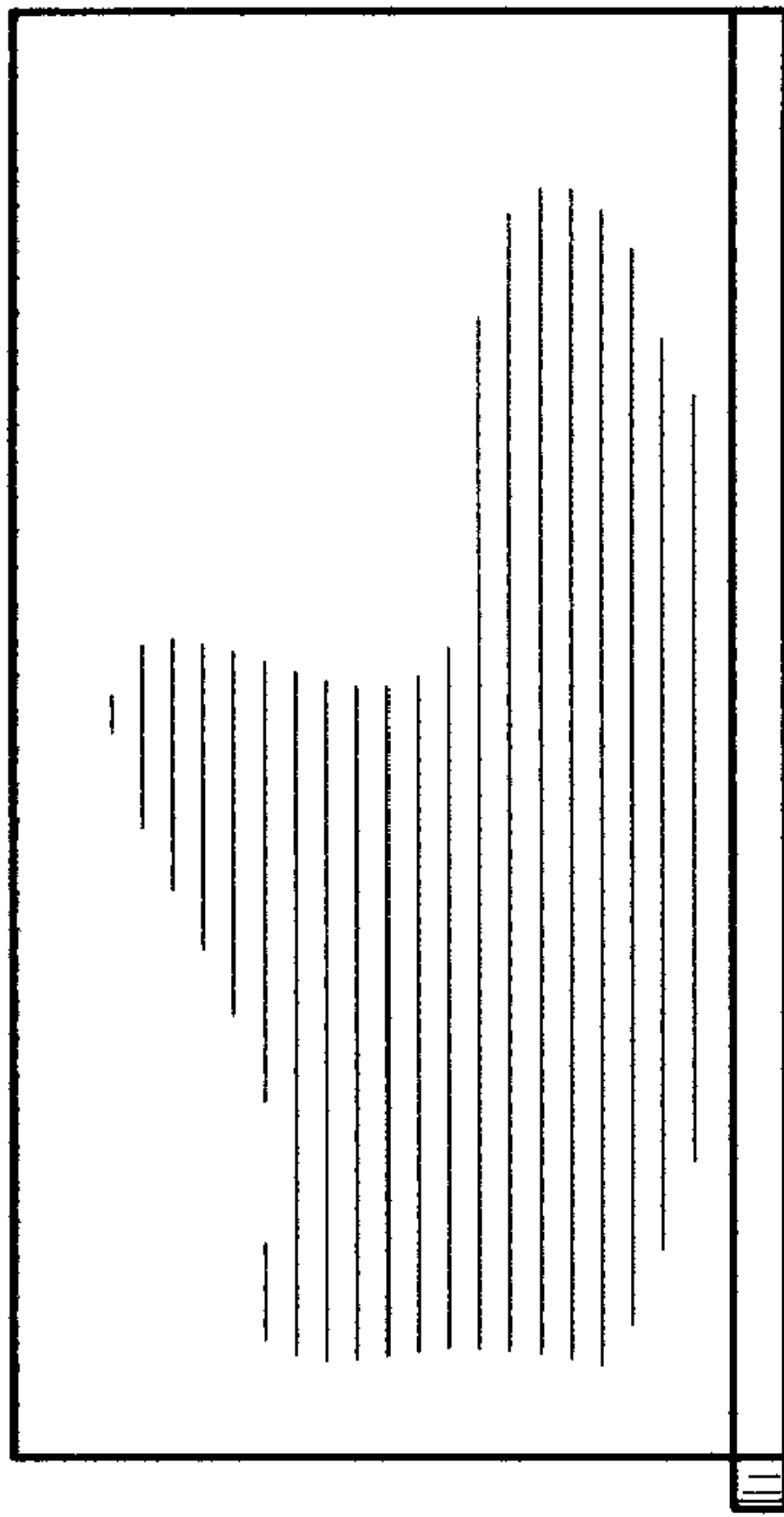

FIG. 3

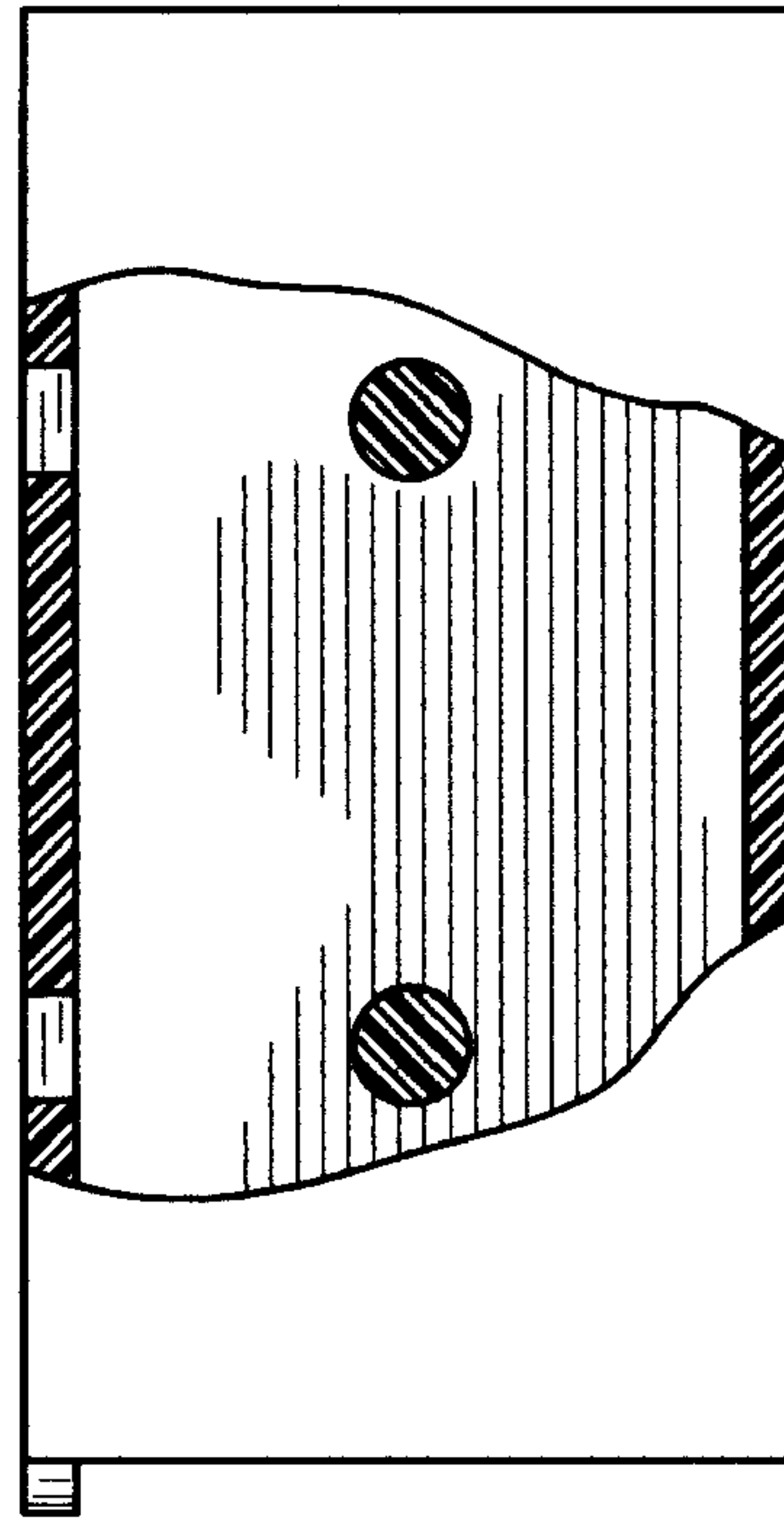

FIG. 4

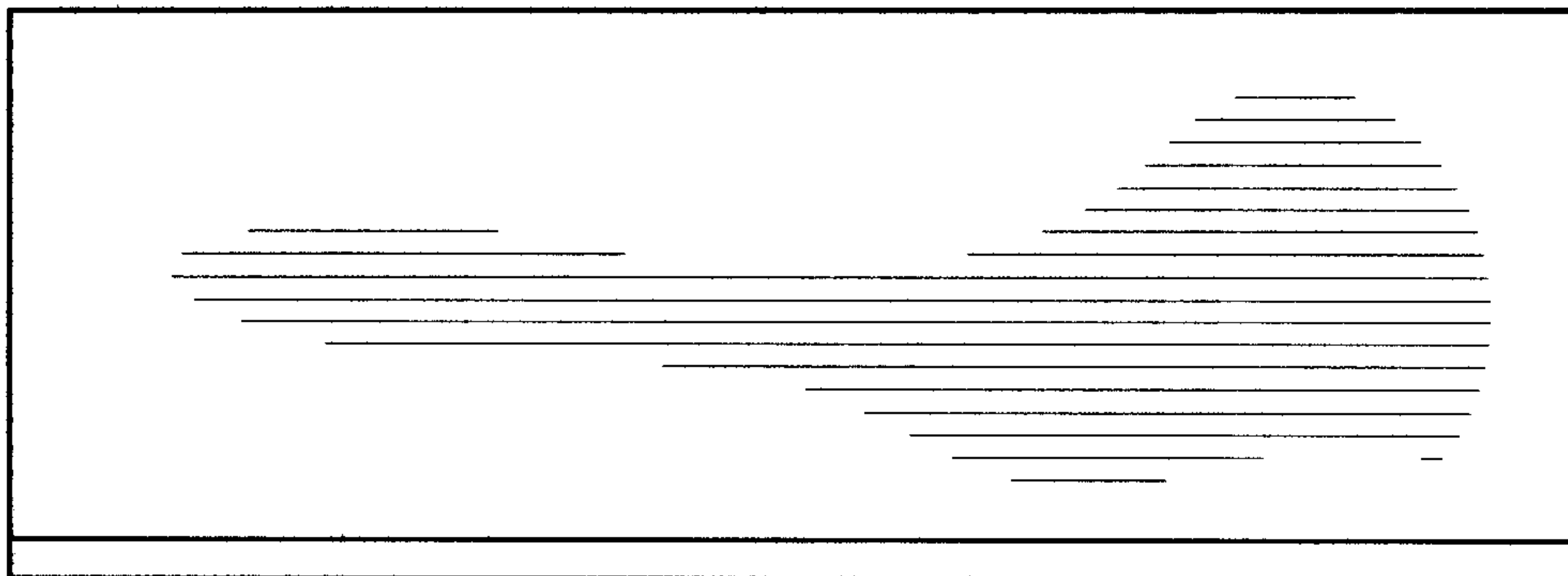

FIG. 5

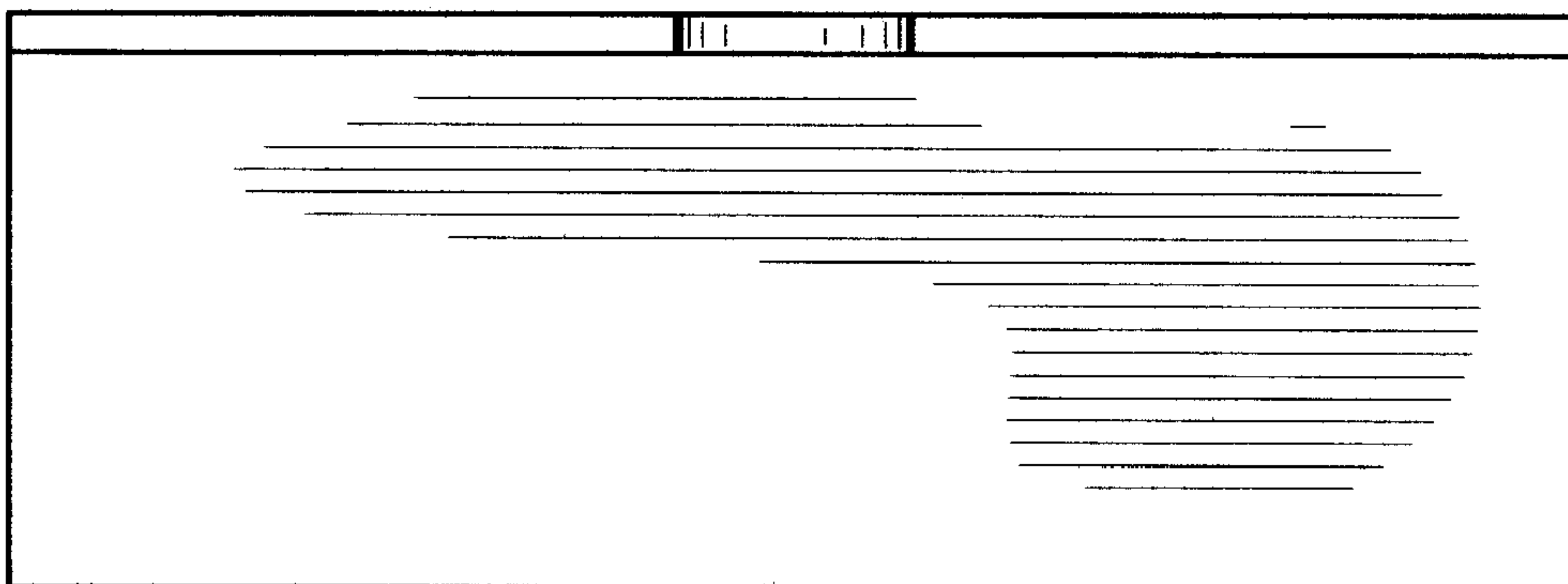

FIG. 6

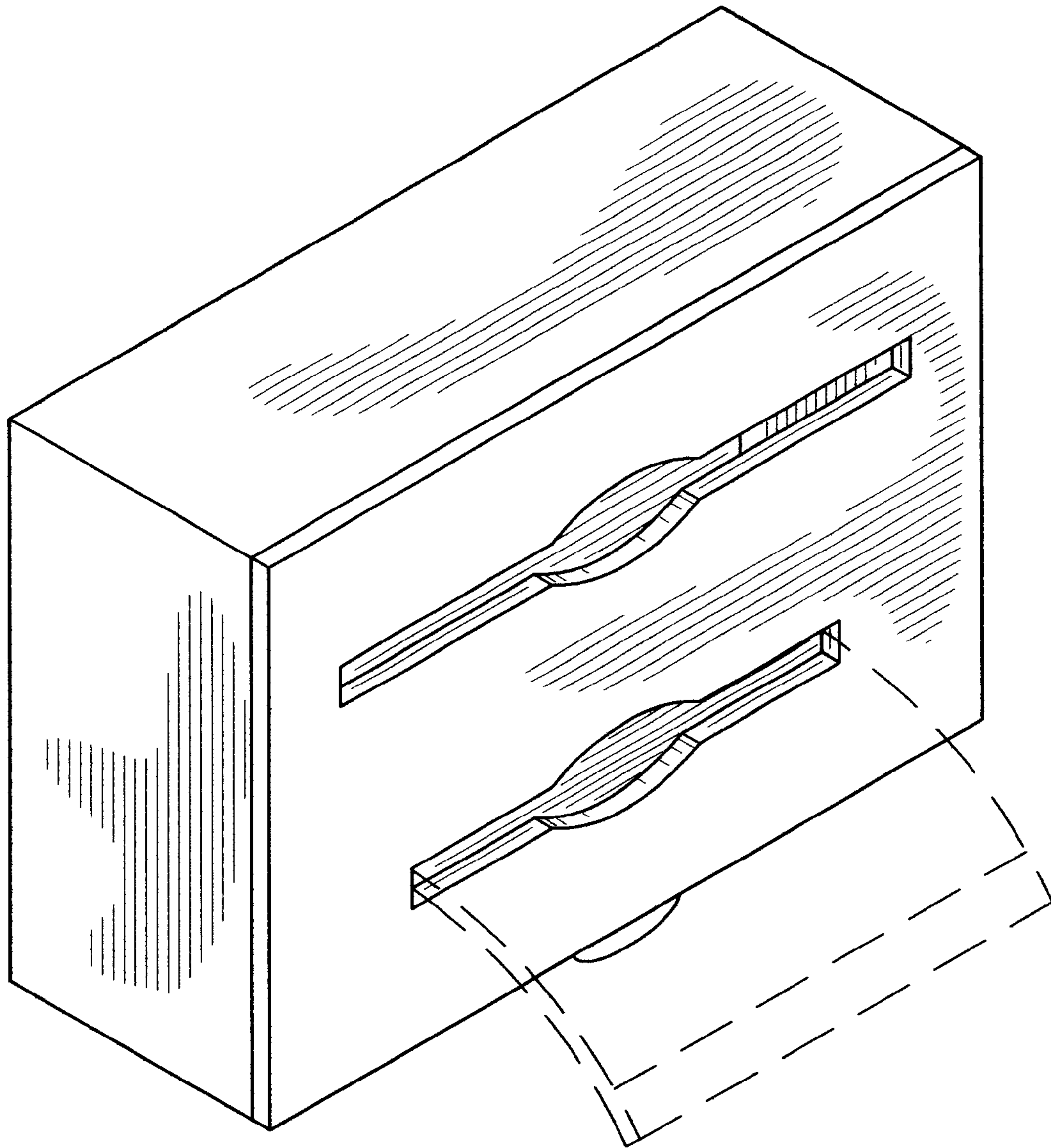

FIG. 7