

US00D523183S

(12) **United States Design Patent**
Harrington

(10) **Patent No.:** **US D523,183 S**
(45) **Date of Patent:** **** Jun. 13, 2006**

(54) **PROTECTIVE HOUSING FOR ANIMAL
FOOD AND WATER BOWLS**

Primary Examiner—Alan P. Douglas
Assistant Examiner—Susan Moon Lee

(76) Inventor: **Robin Joseph Harrington**, P.O. Box
700453, Kapolei, HI (US) 96709

(57) **CLAIM**

The ornamental design for a protective housing for animal food and water bowls, as shown and described.

(**) Term: **14 Years**

(21) Appl. No.: **29/223,725**

DESCRIPTION

(22) Filed: **Feb. 18, 2005**

(51) **LOC (8) Cl.** **30-02**

(52) **U.S. Cl.** **D30/109**

(58) **Field of Classification Search** 119/416,
119/452-54, 482, 496-97, 500-501, 514-15,
119/751, 801; D30/108, 109, 114, 119, 120-21,
D30/161, 199; 190/39; 220/476; 312/138.1
See application file for complete search history.

FIG. 1 is a front perspective view of a protective housing for animal food and water bowls showing my new design;
FIG. 2 is a front elevation view thereof;
FIG. 3 is a first side elevation view thereof;
FIG. 4 is a second side elevation view thereof;
FIG. 5 is a rear elevation view thereof;
FIG. 6 is a top plan view thereof;
FIG. 7 is a bottom plan view thereof; and
FIG. 8 is a front perspective view thereof with the door shown open.

(56) **References Cited**

U.S. PATENT DOCUMENTS

1,395,976 A	*	11/1921	Riley	312/137
2,079,458 A	*	5/1937	Leichtfuss	220/7
D193,769 S	*	10/1962	Kerr	D30/109
D211,526 S	*	6/1968	Ikelheimer	D30/109
D254,631 S	*	4/1980	Albright	D30/109
D293,762 S	*	1/1988	Polley	D7/391
D298,870 S	*	12/1988	Heisler	D30/109
5,020,684 A	*	6/1991	Jow	220/4.24
5,357,900 A	*	10/1994	Ho	119/479
D432,740 S	*	10/2000	Morley	D30/119
D456,710 S	*	5/2002	Persson	D9/431

FIG. 9 is a front perspective view of a protective housing for animal food and water bowls showing my new design according to a second embodiment.
FIG. 10 is a front elevation view thereof;
FIG. 11 is a first side elevation view thereof;
FIG. 12 is a second side elevation view thereof;
FIG. 13 is a rear elevation view thereof;
FIG. 14 is a top plan view thereof; and
FIG. 15 is a bottom plan view thereof.

* cited by examiner

1 Claim, 5 Drawing Sheets

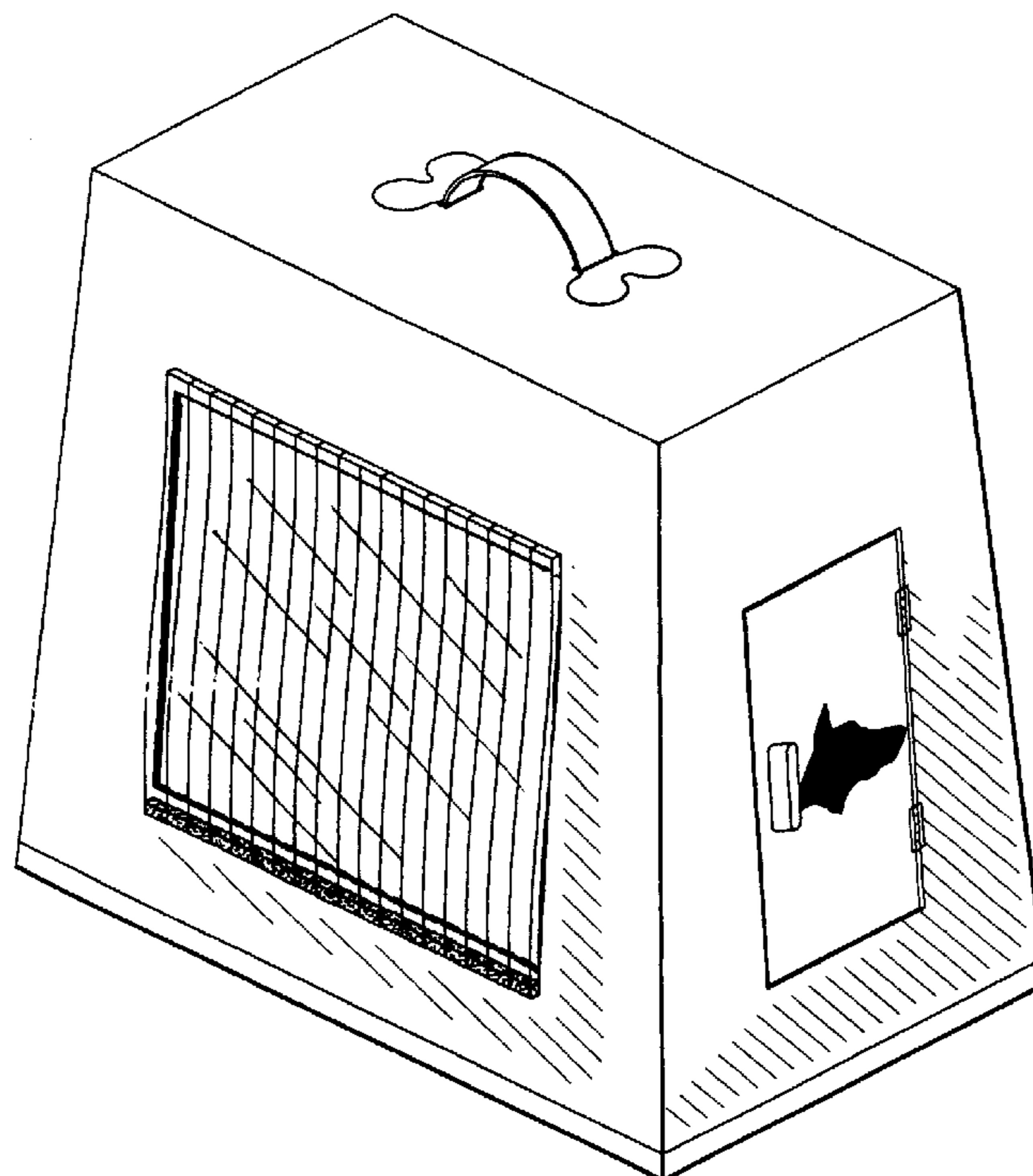

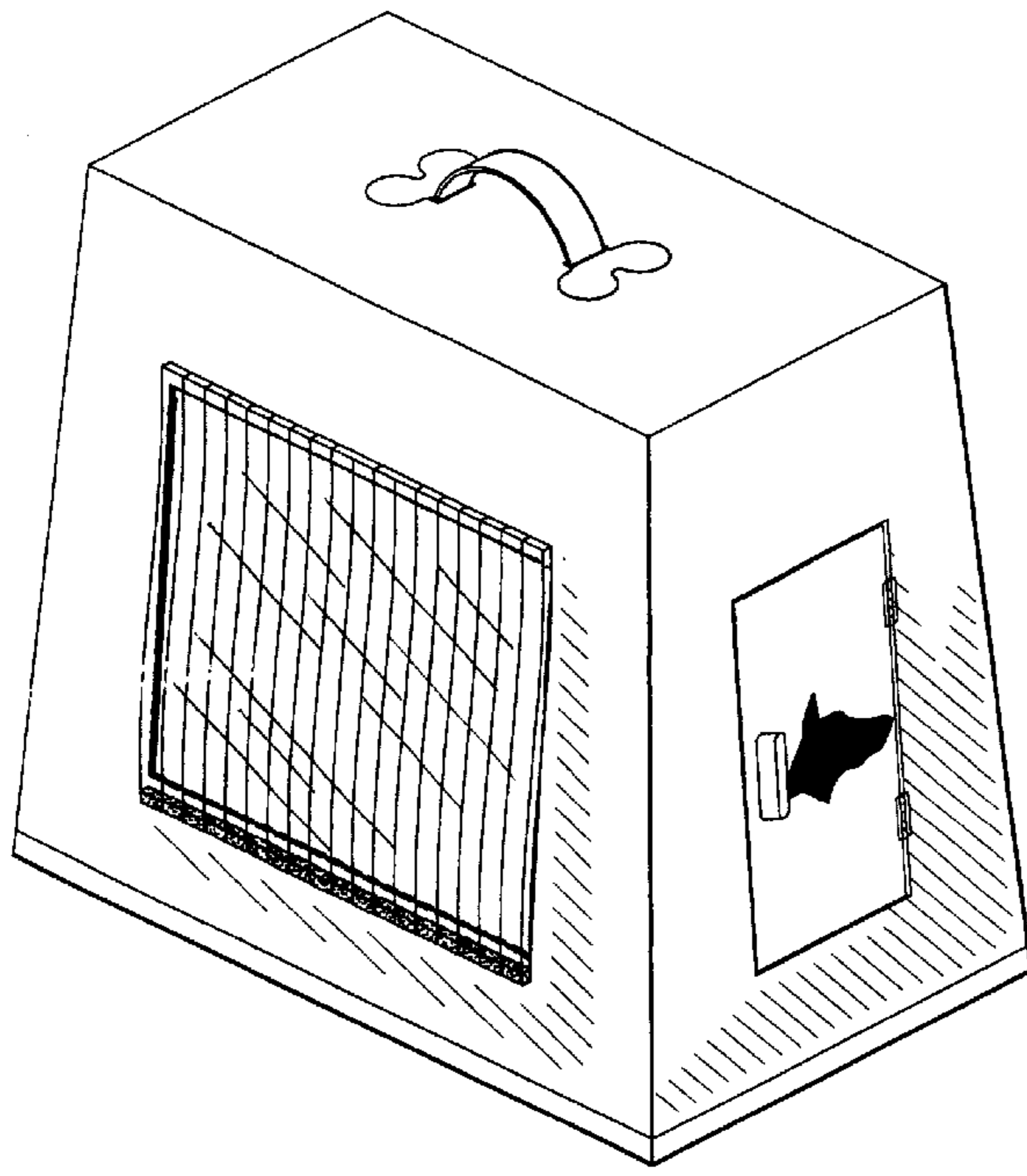

FIG. 1

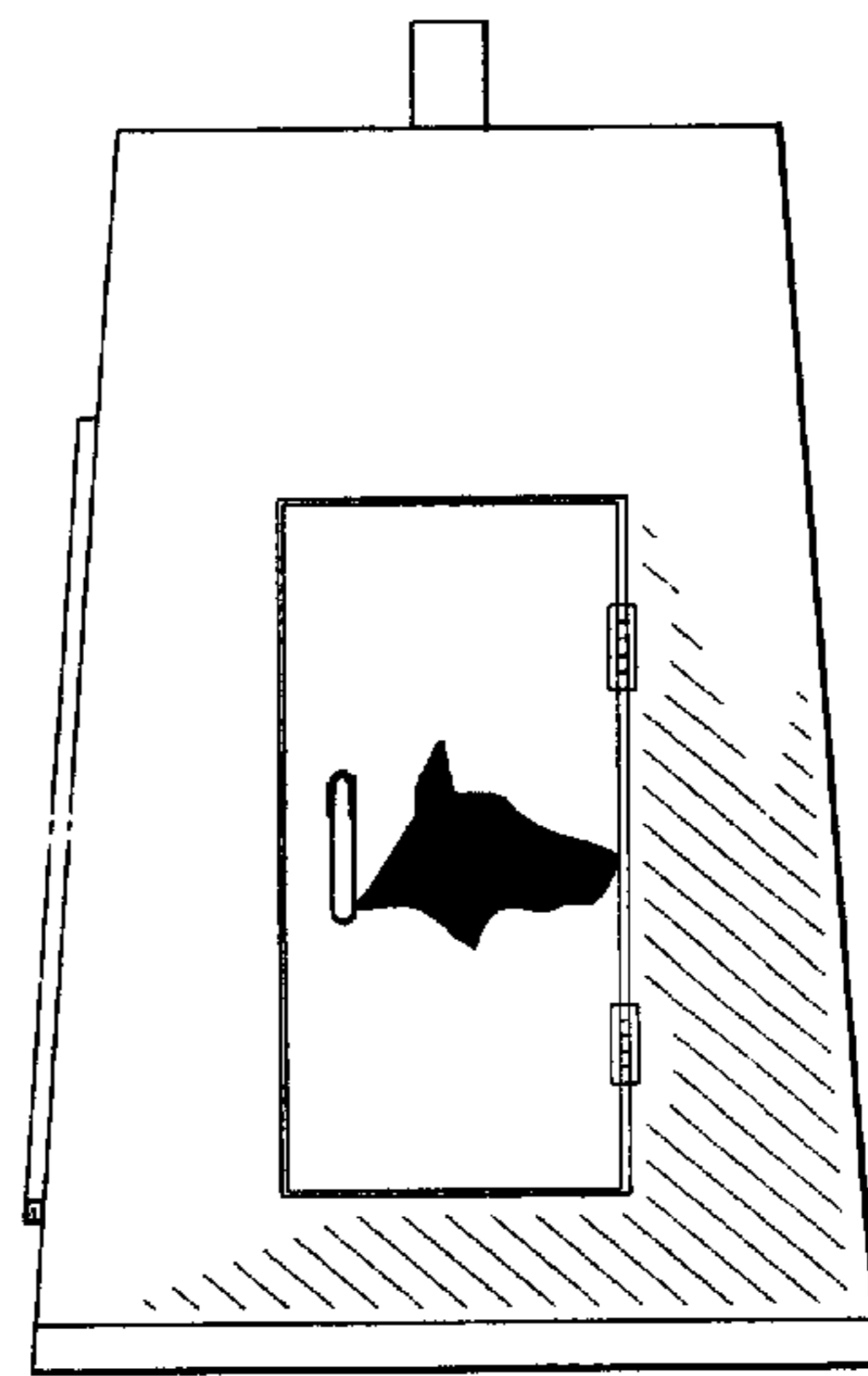

FIG. 3

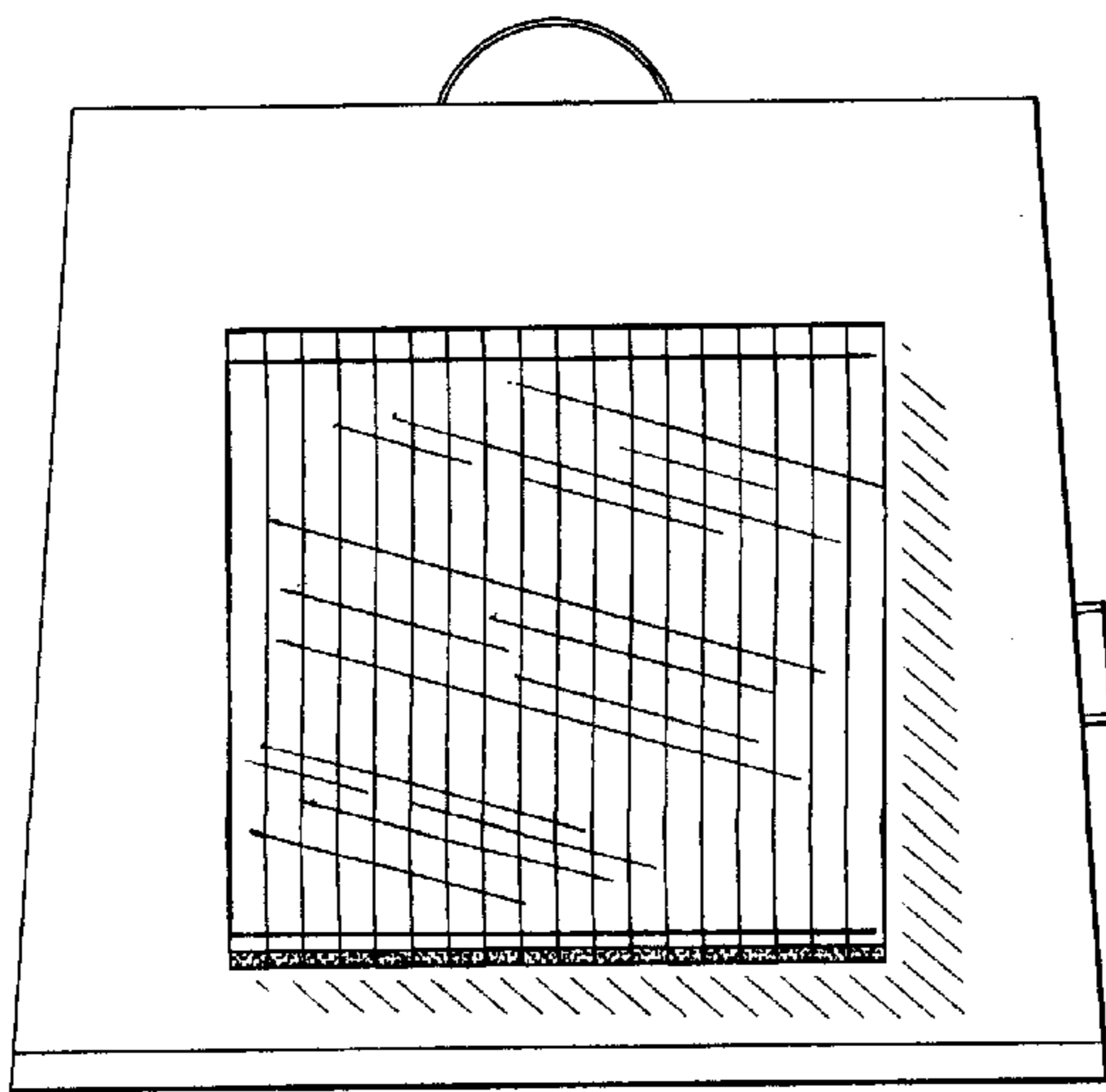

FIG. 2

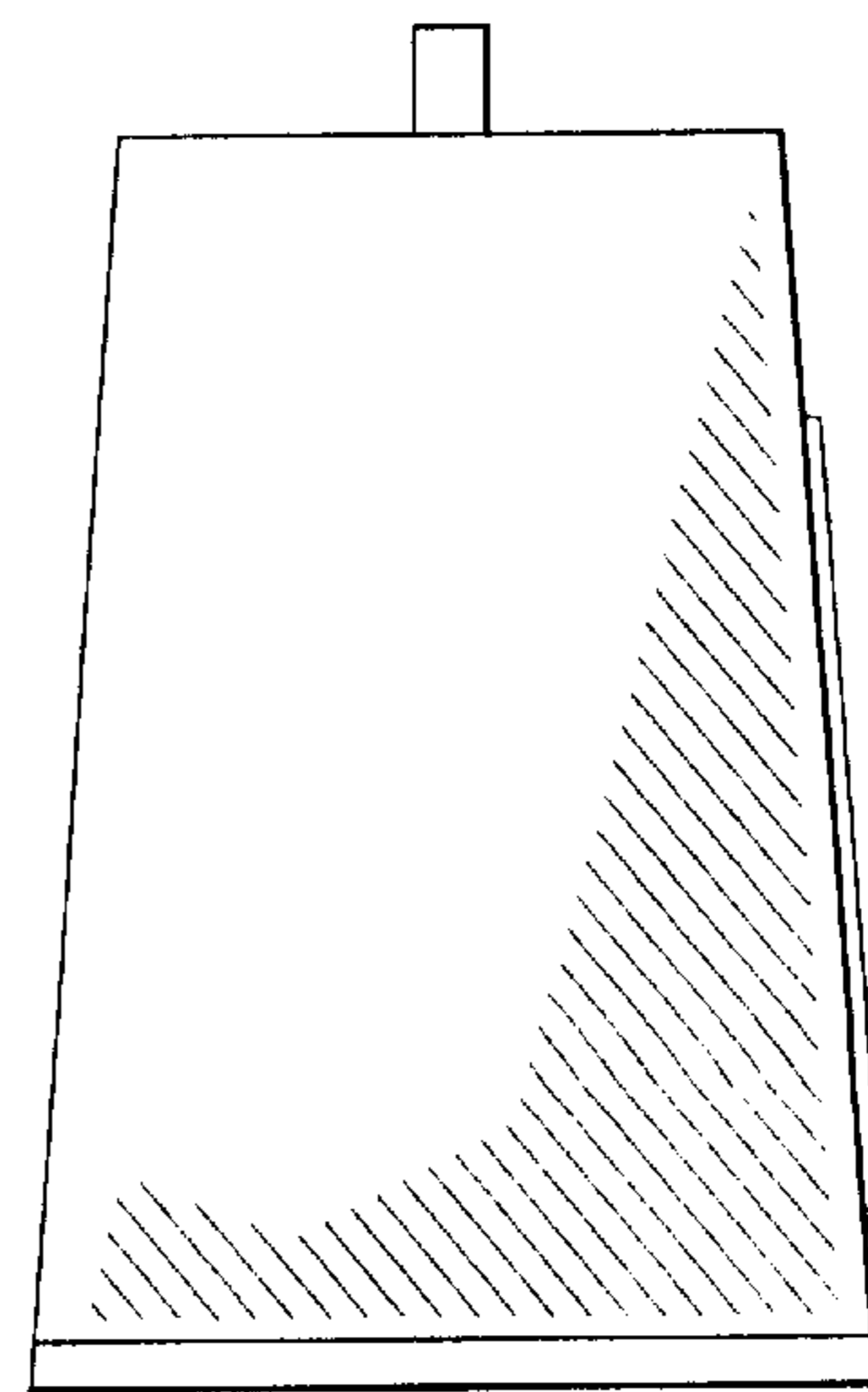

FIG. 4

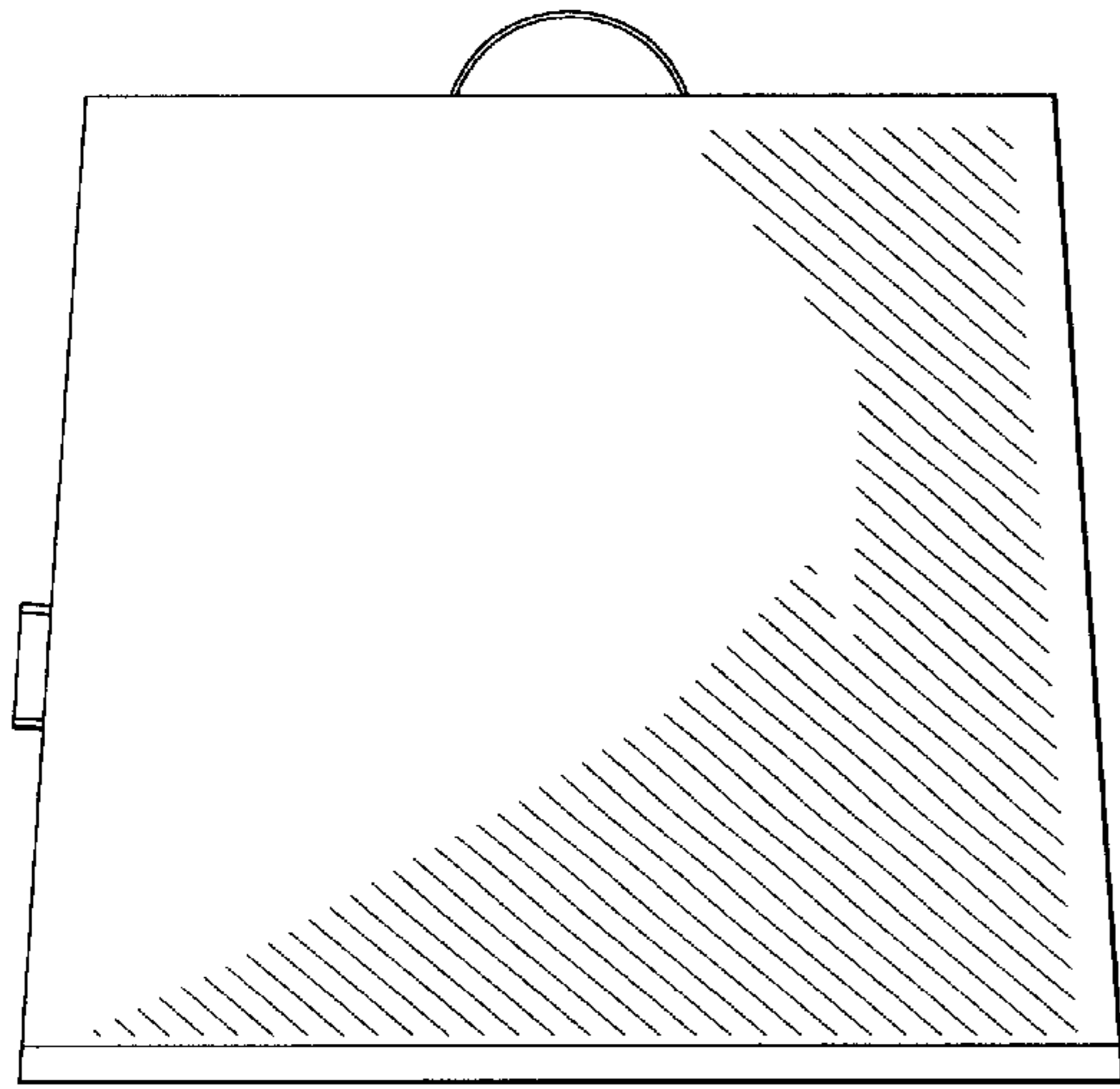

FIG. 5

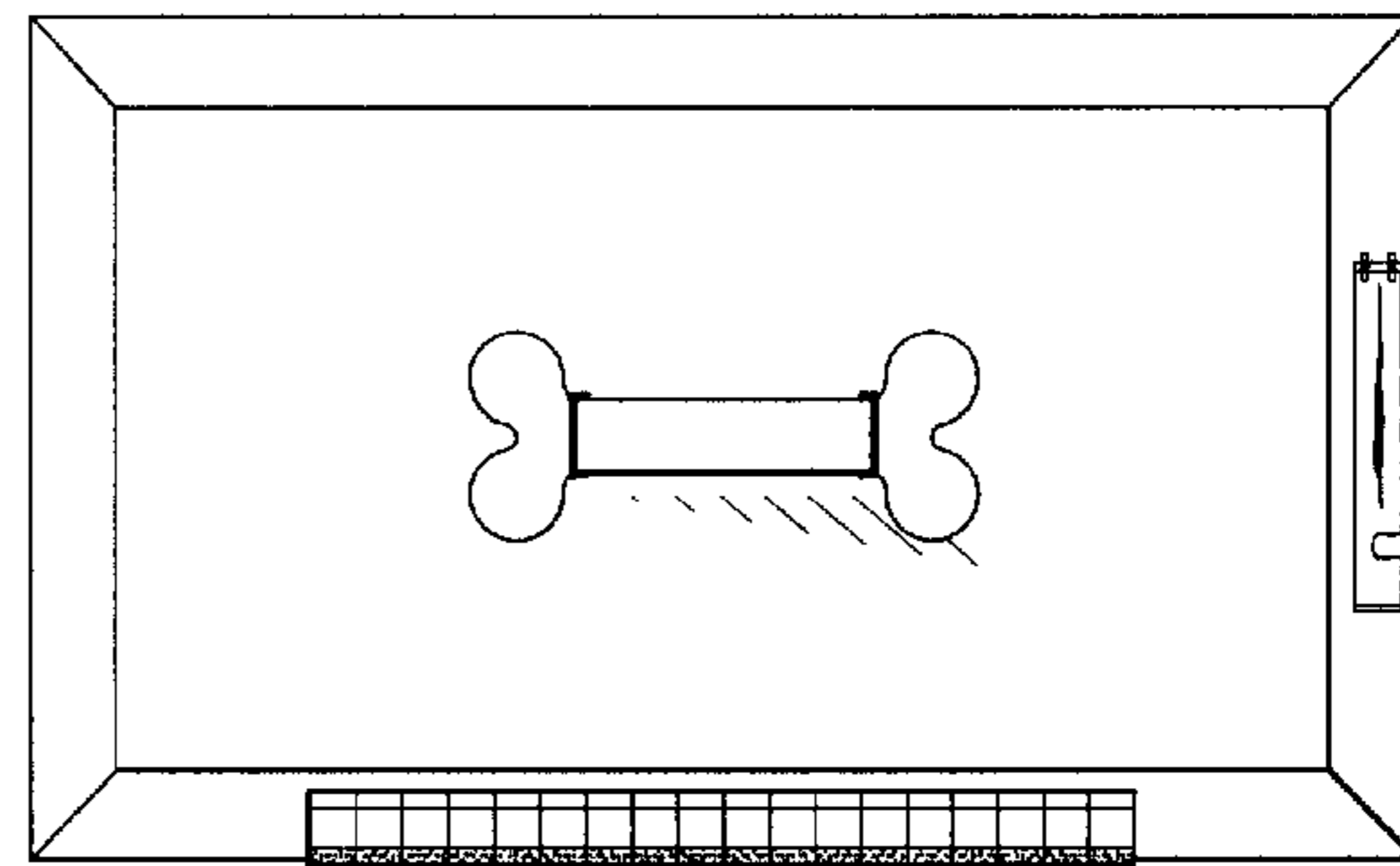

FIG. 6

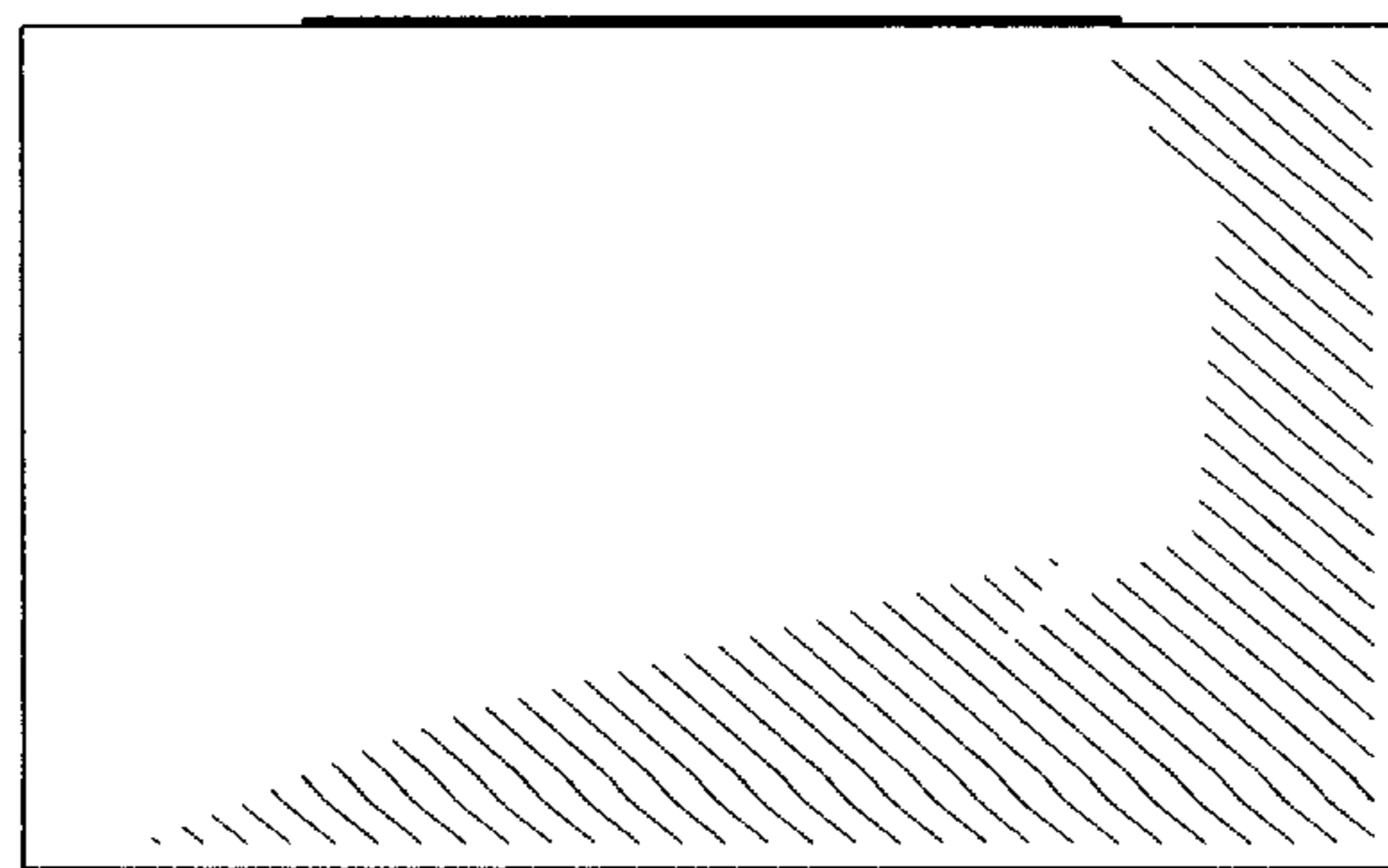

FIG. 7

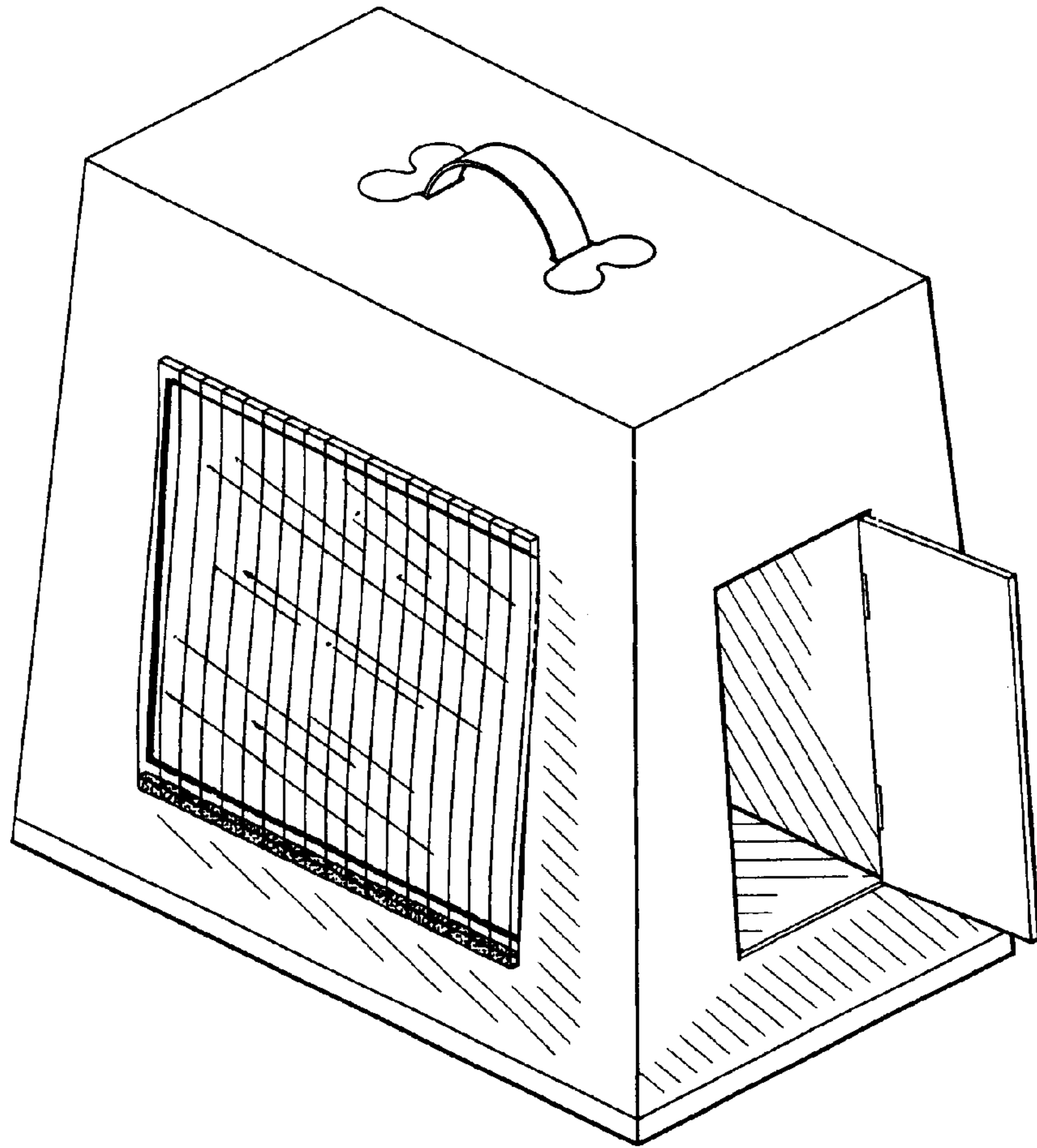

FIG. 8

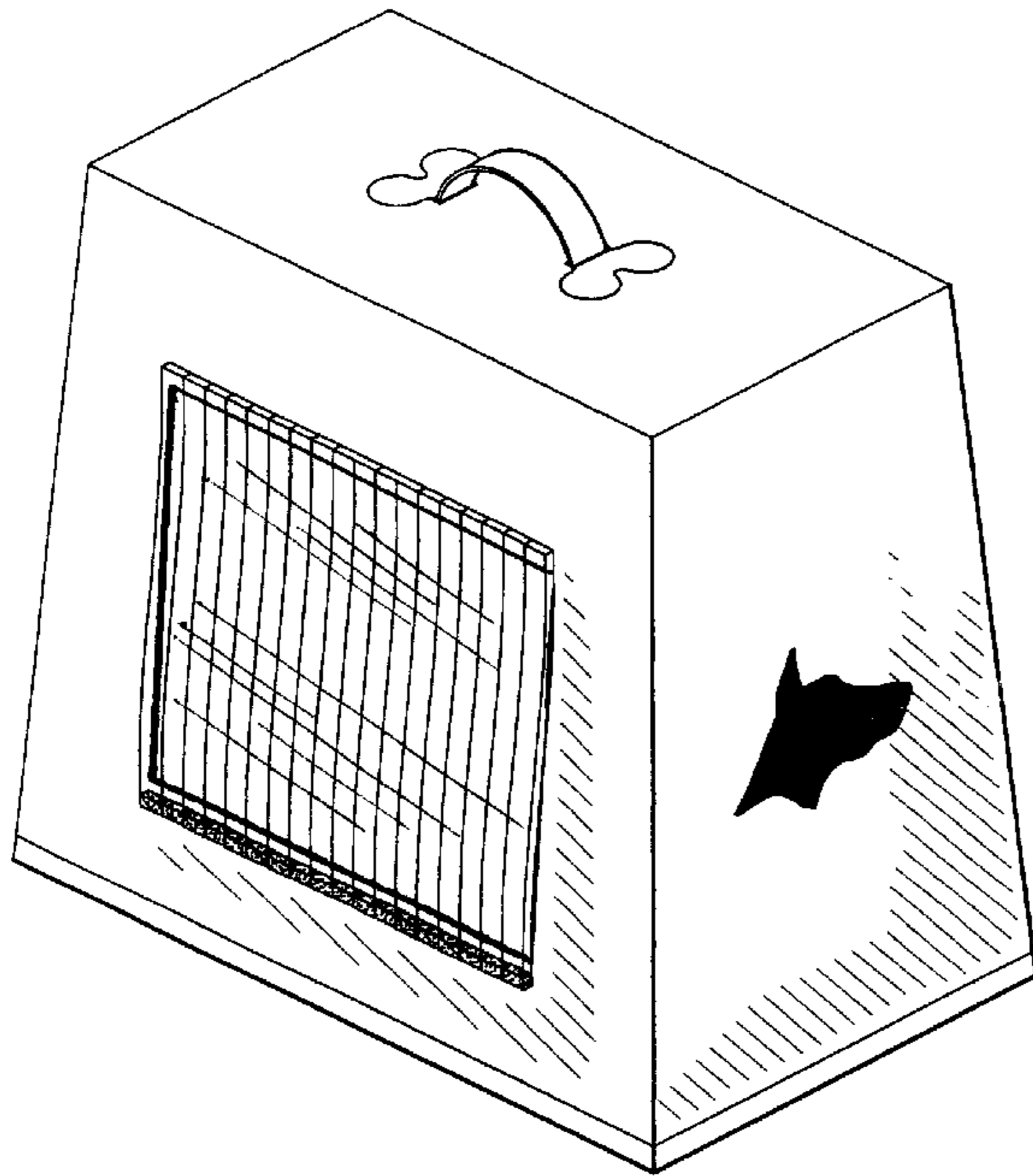

FIG. 9

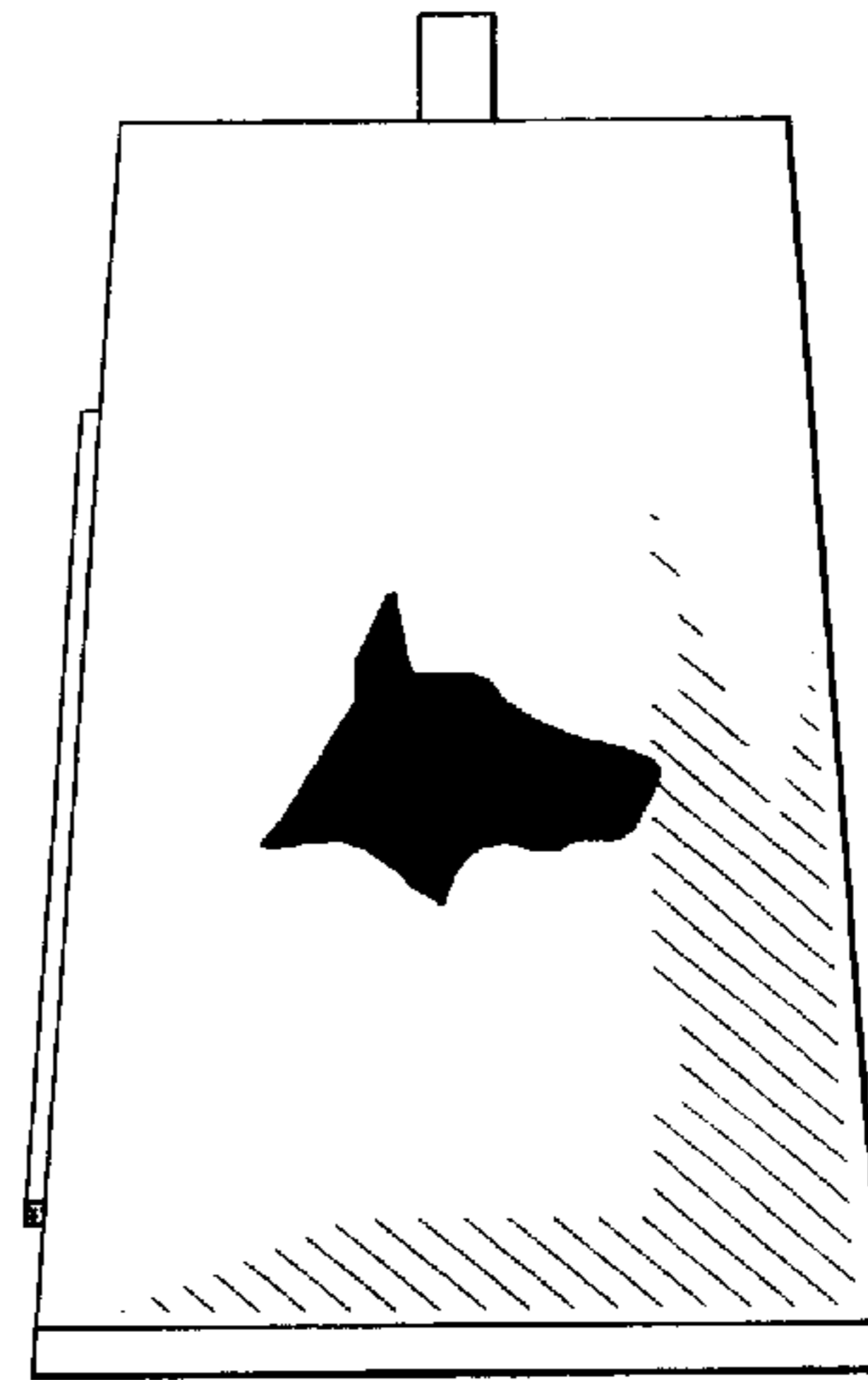

FIG. 11

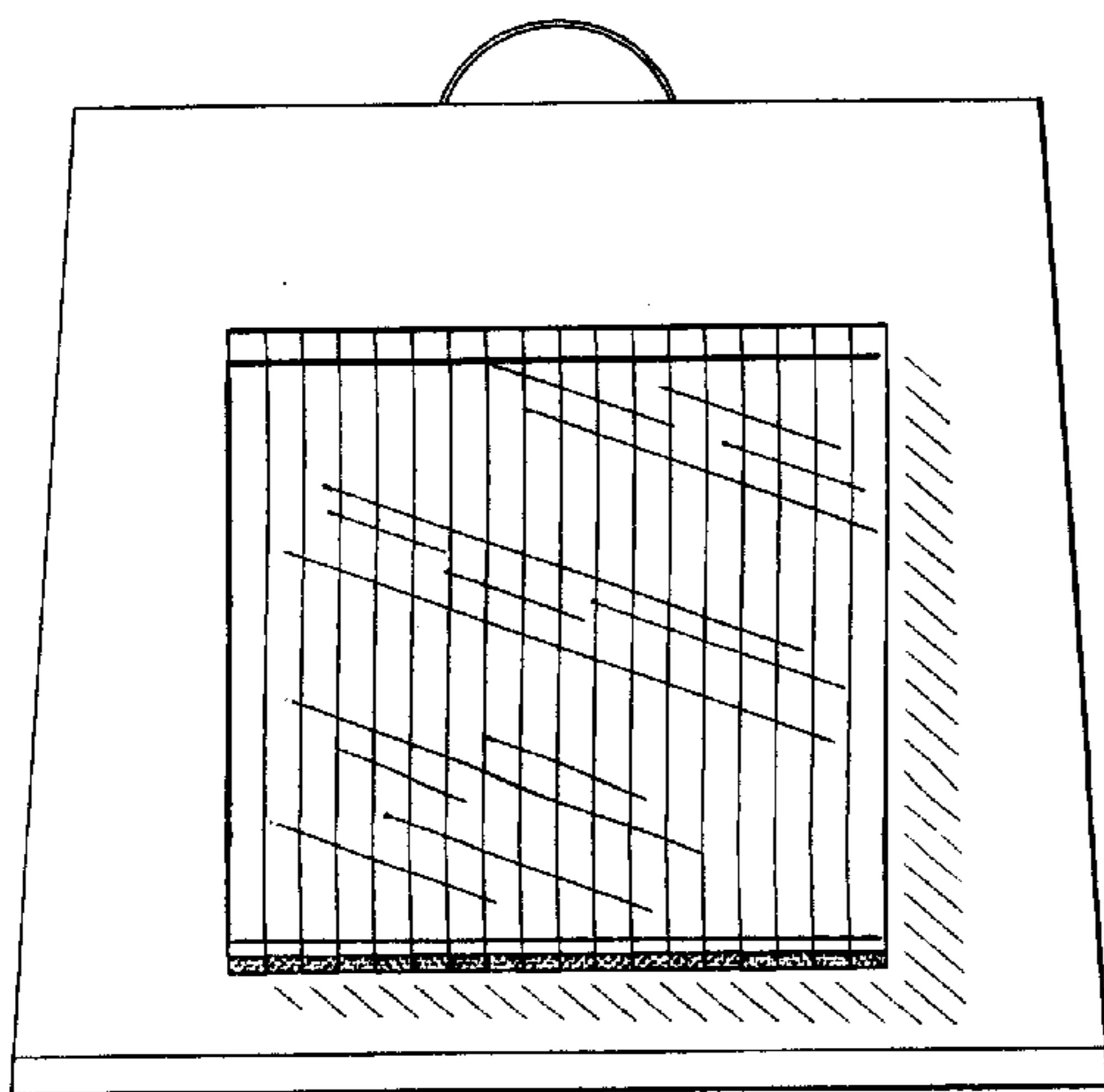

FIG. 10

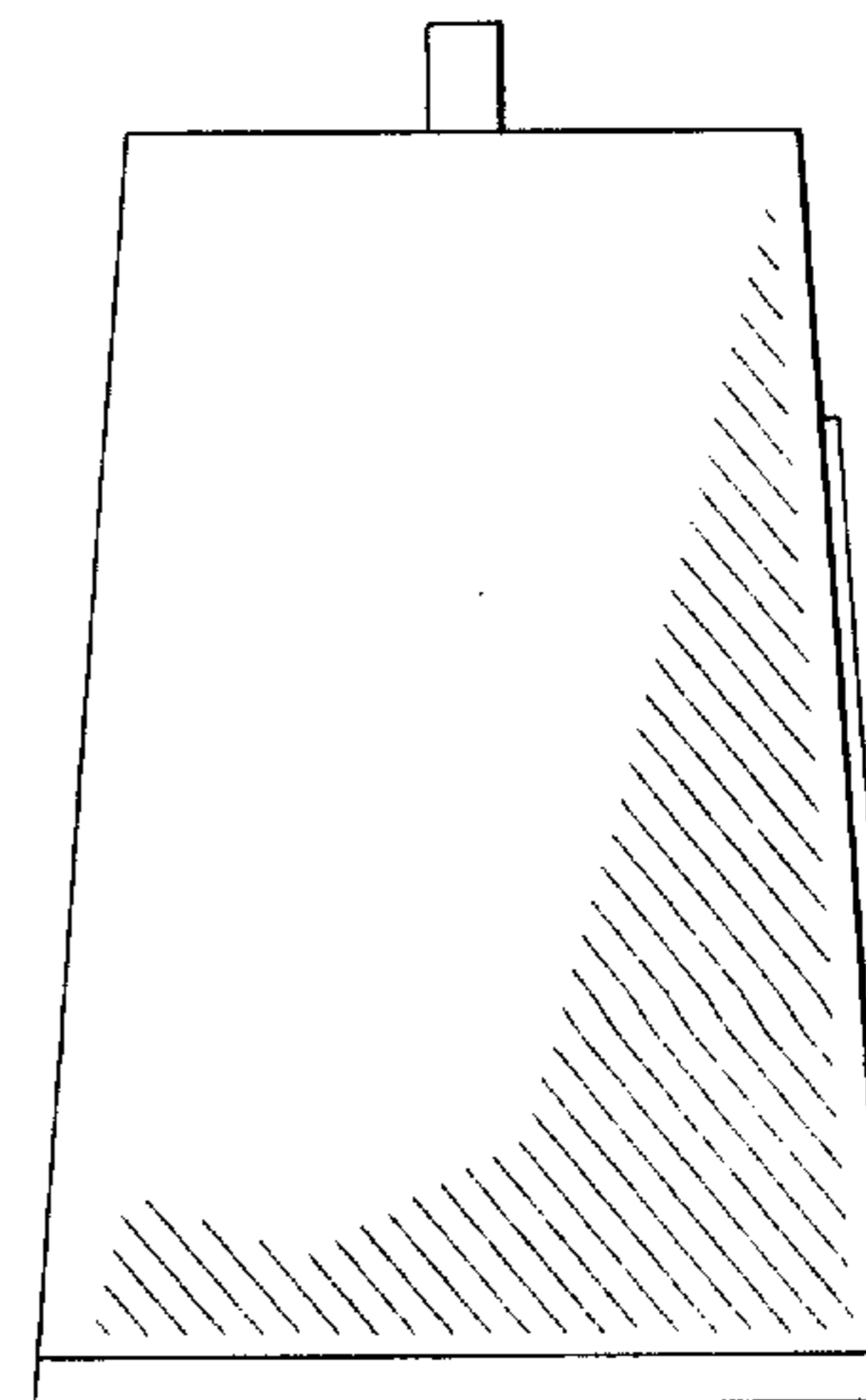

FIG. 12

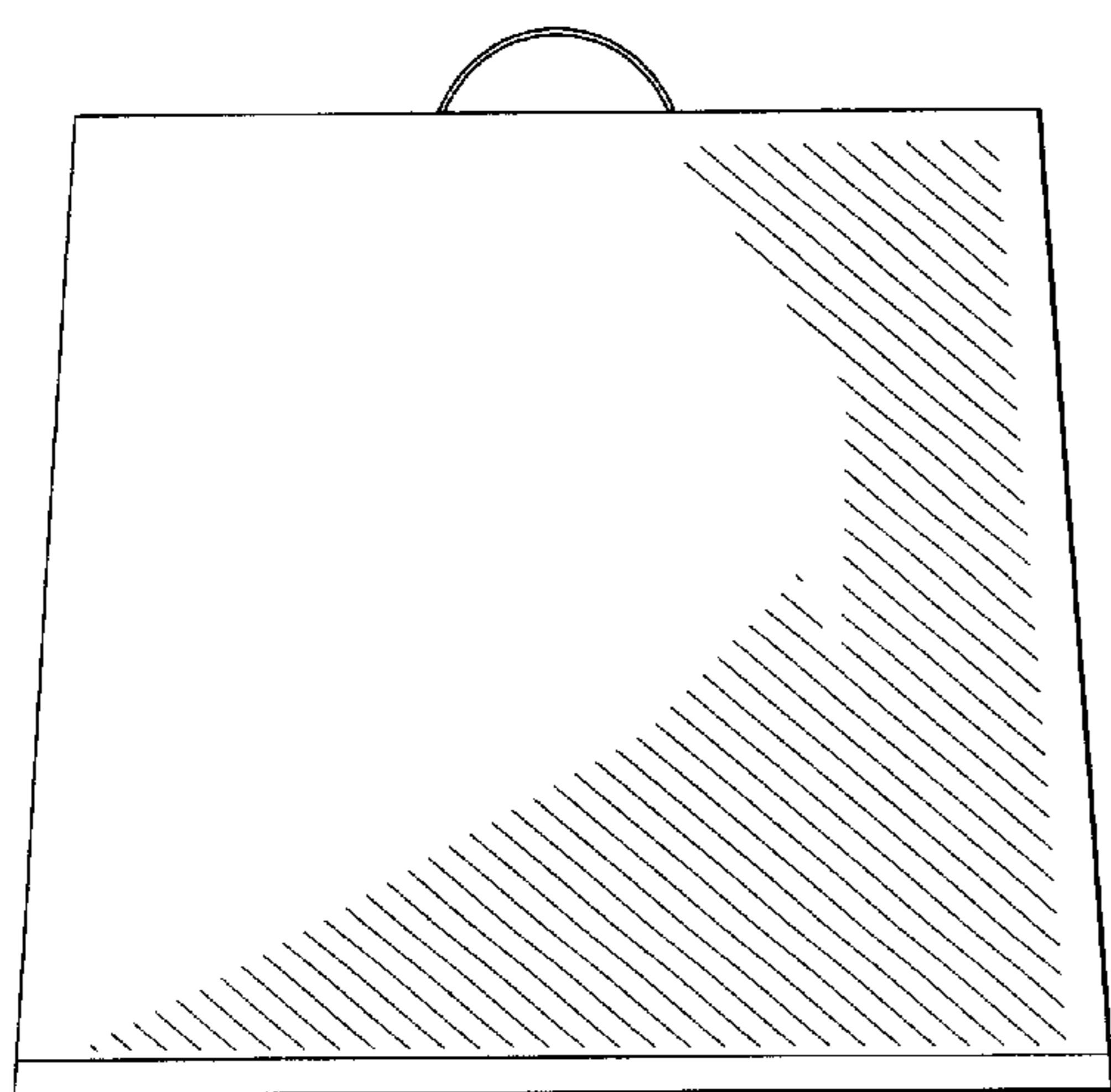

FIG. 13

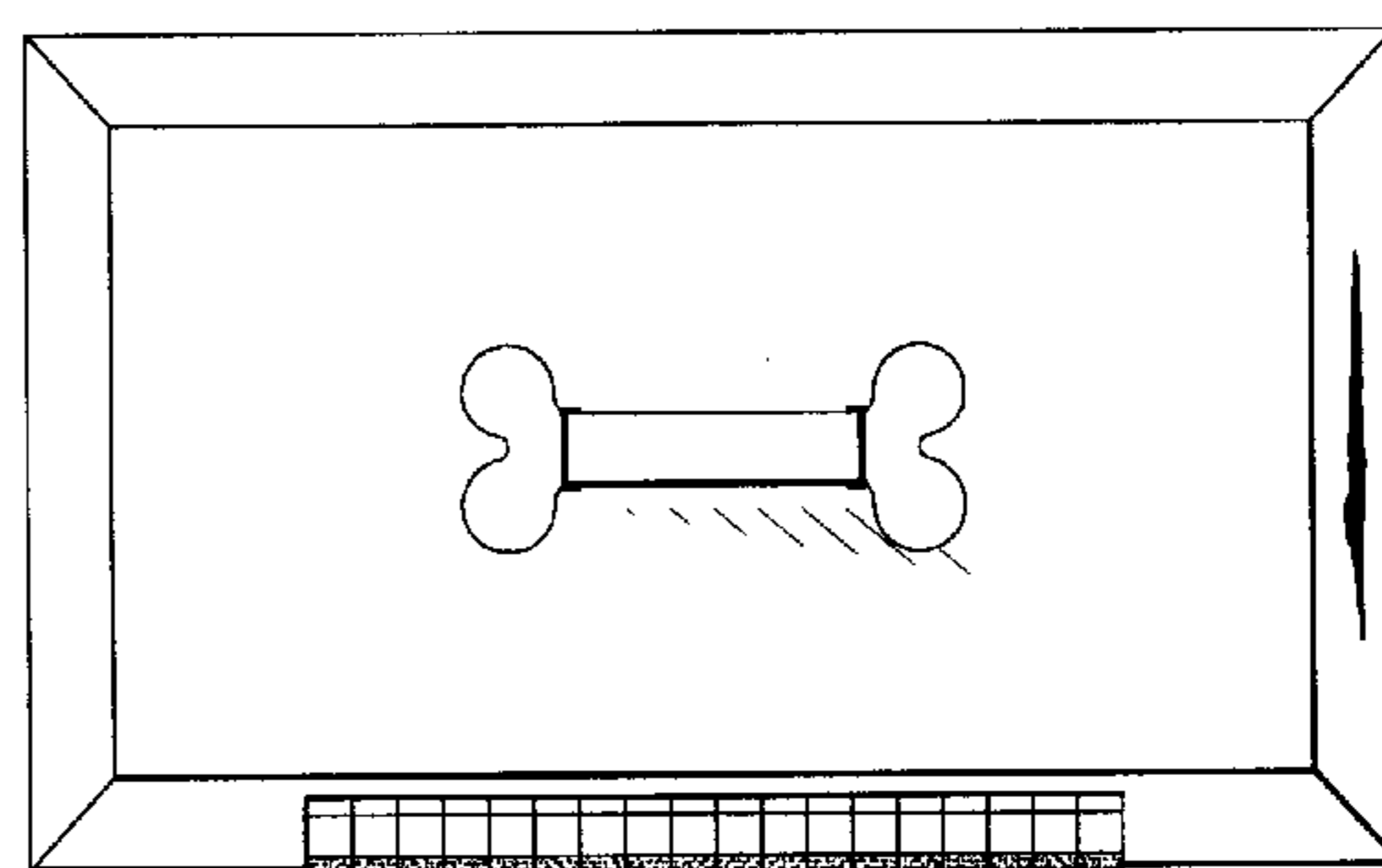

FIG. 14

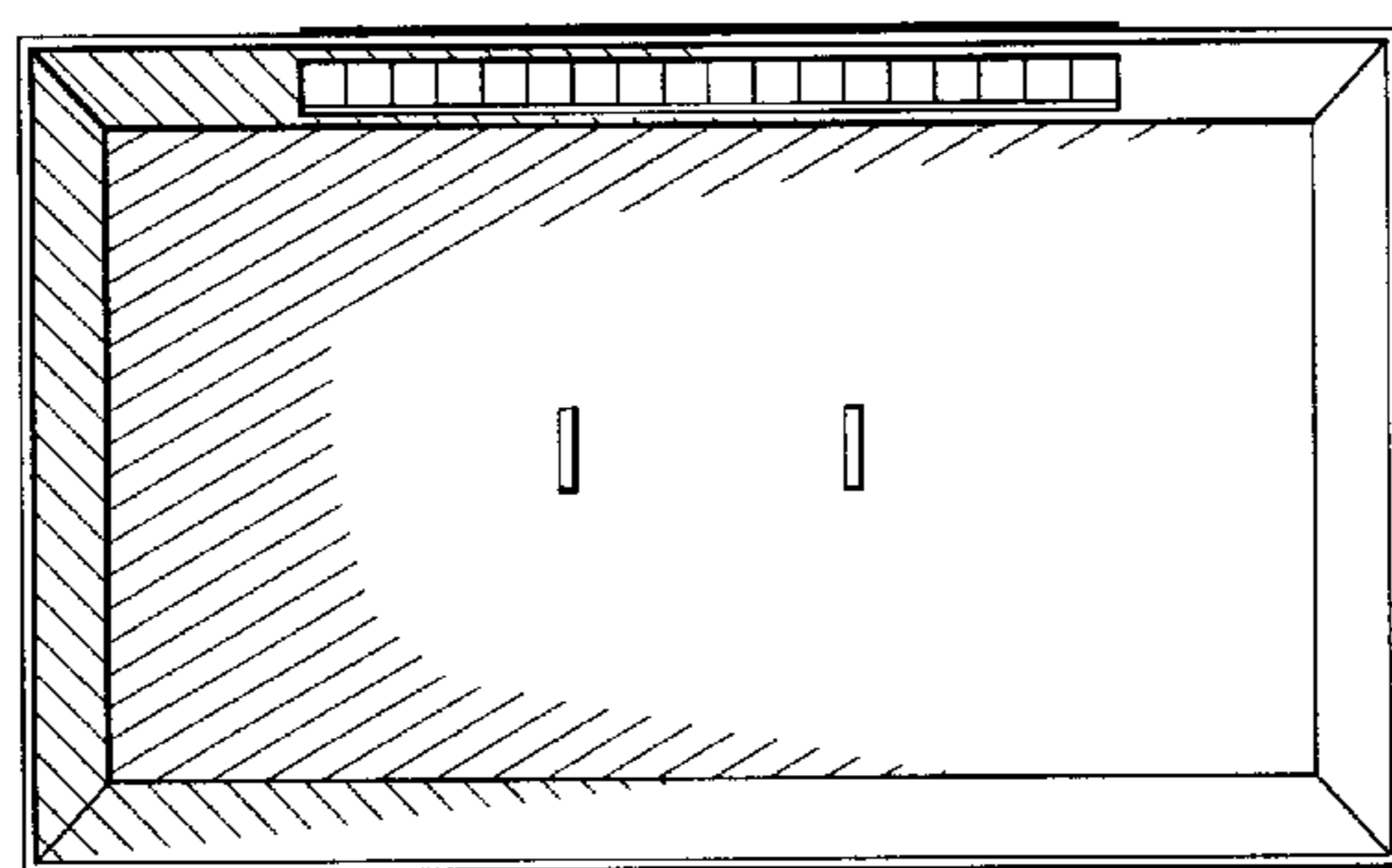

FIG. 15