



US00D523098S

(12) **United States Design Patent**
Keegan

(10) **Patent No.:** **US D523,098 S**
(45) **Date of Patent:** **** Jun. 13, 2006**

(54) **HAND-WRIST SWIM EXERCISE DEVICE**
(75) Inventor: **Steven Keegan**, Los Angeles, CA (US)

D348,914 S * 7/1994 Shelton D21/678
D367,089 S * 2/1996 Hughes et al. D21/678
6,955,633 B1 * 10/2005 Stout 482/55

(73) Assignee: **Warnaco Swimwear Incorporated**,
Commerce, CA (US)

OTHER PUBLICATIONS

Keifer catalog, Holiday 2003 catalog, p. 58, swim workout equipment, found on Google catalogs search engine.*

(**) Term: **14 Years**

* cited by examiner

(21) Appl. No.: **29/223,350**

Primary Examiner—Philip S. Hyder

(22) Filed: **Feb. 11, 2005**

(74) *Attorney, Agent, or Firm*—Katten Muchin Rosenman LLP

(51) **LOC (8) Cl.** **21-02**

(52) **U.S. Cl.** **D21/678; D21/806**

(57) **CLAIM**

(58) **Field of Classification Search** D21/806,
D21/662, 678, 679, 682, 684, 685; 482/108,
482/111, 55

The ornamental design for a hand-wrist swim exercise device, as shown and described.

See application file for complete search history.

DESCRIPTION

(56) **References Cited**

FIG. 1 is a perspective view of a hand-wrist swim exercise device showing my new design;
FIG. 2 is a rear edge view thereof;
FIG. 3 is a front edge view thereof;
FIG. 4 is a right edge view thereof;
FIG. 5 is a left edge view thereof;
FIG. 6 is a top elevation view thereof; and,
FIG. 7 is a bottom elevation view thereof.

U.S. PATENT DOCUMENTS

4,311,306	A	*	1/1982	Solloway	482/111
4,458,896	A	*	7/1984	Solloway	482/111
4,521,011	A	*	6/1985	Solloway	482/111
4,623,142	A	*	11/1986	MacKechnie	482/111
4,819,951	A	*	4/1989	Solloway	482/111
D309,763	S	*	8/1990	Solloway	D21/678
5,033,739	A	*	7/1991	MacKechnie	482/111
D344,113	S	*	2/1994	Shelton et al.	D21/678

1 Claim, 7 Drawing Sheets

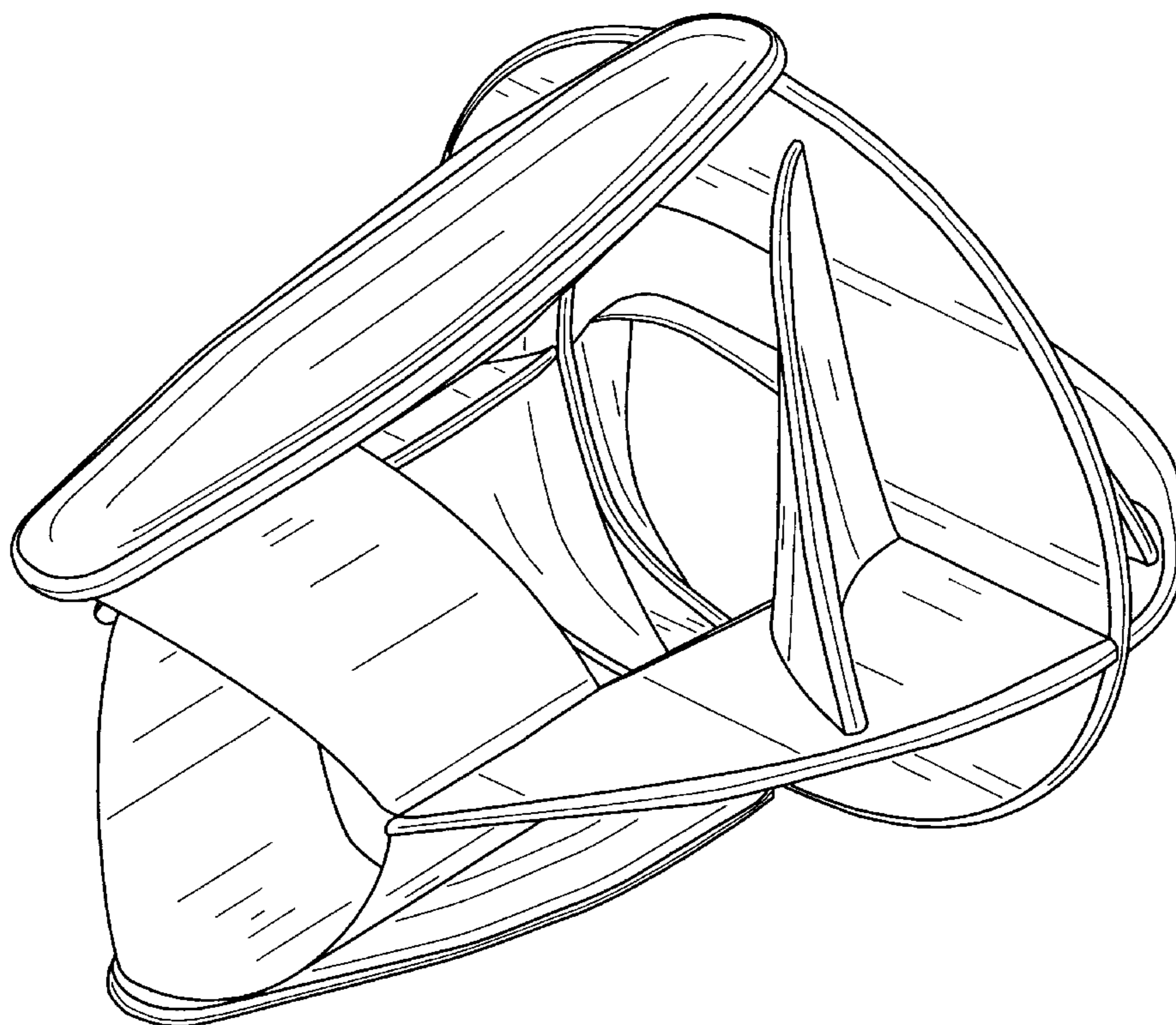

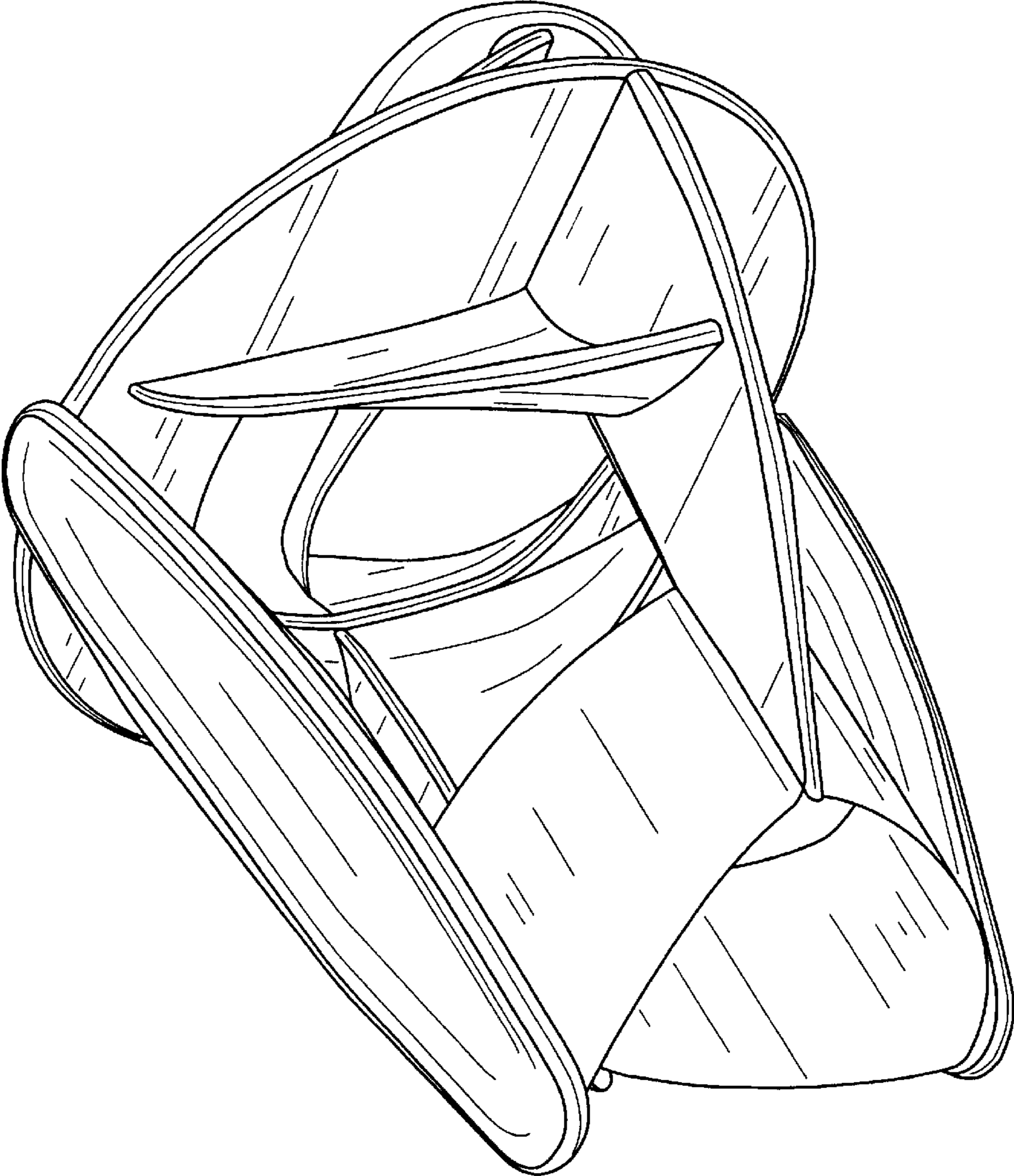

FIG. 1

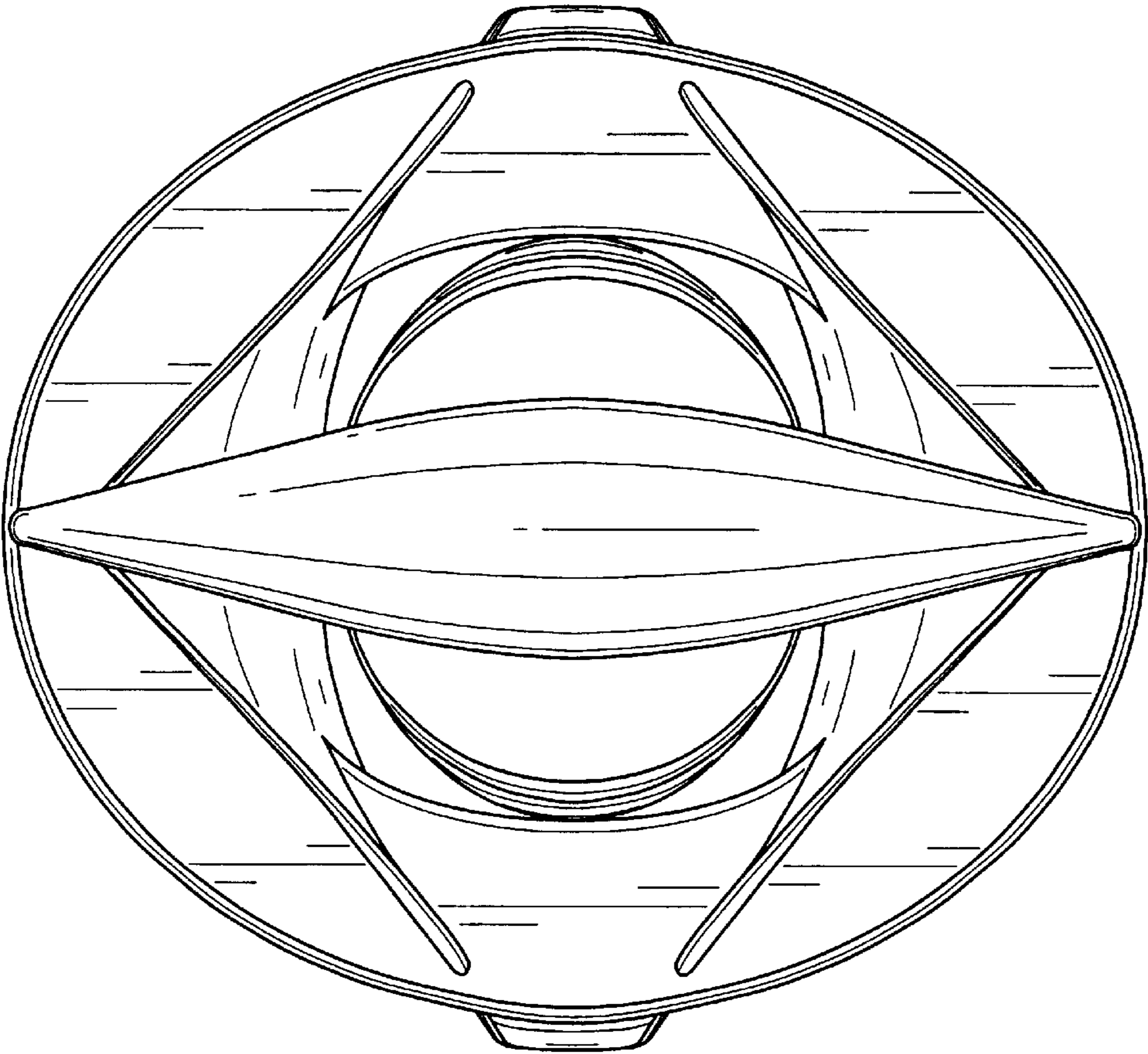

FIG. 2

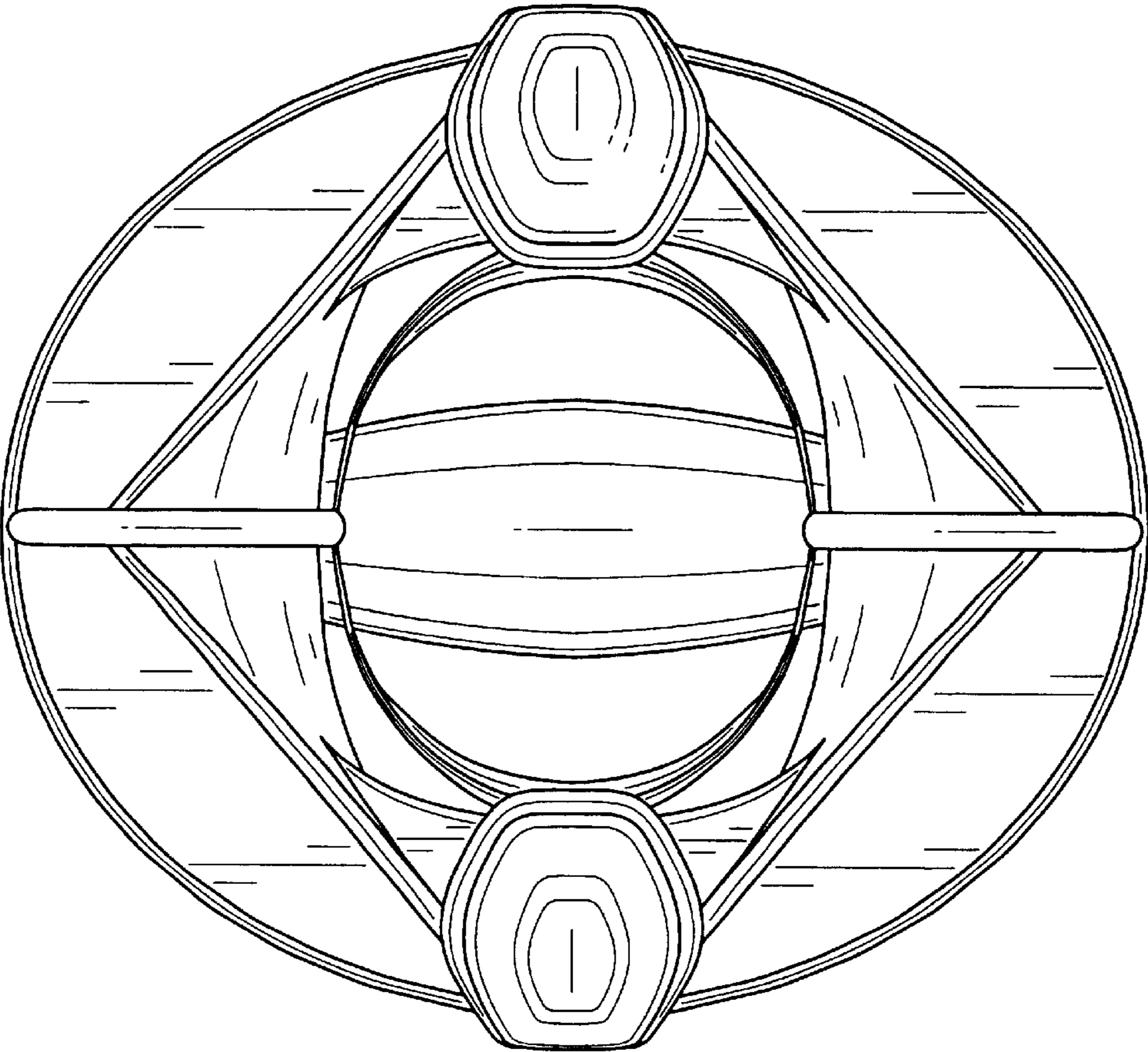

FIG. 3

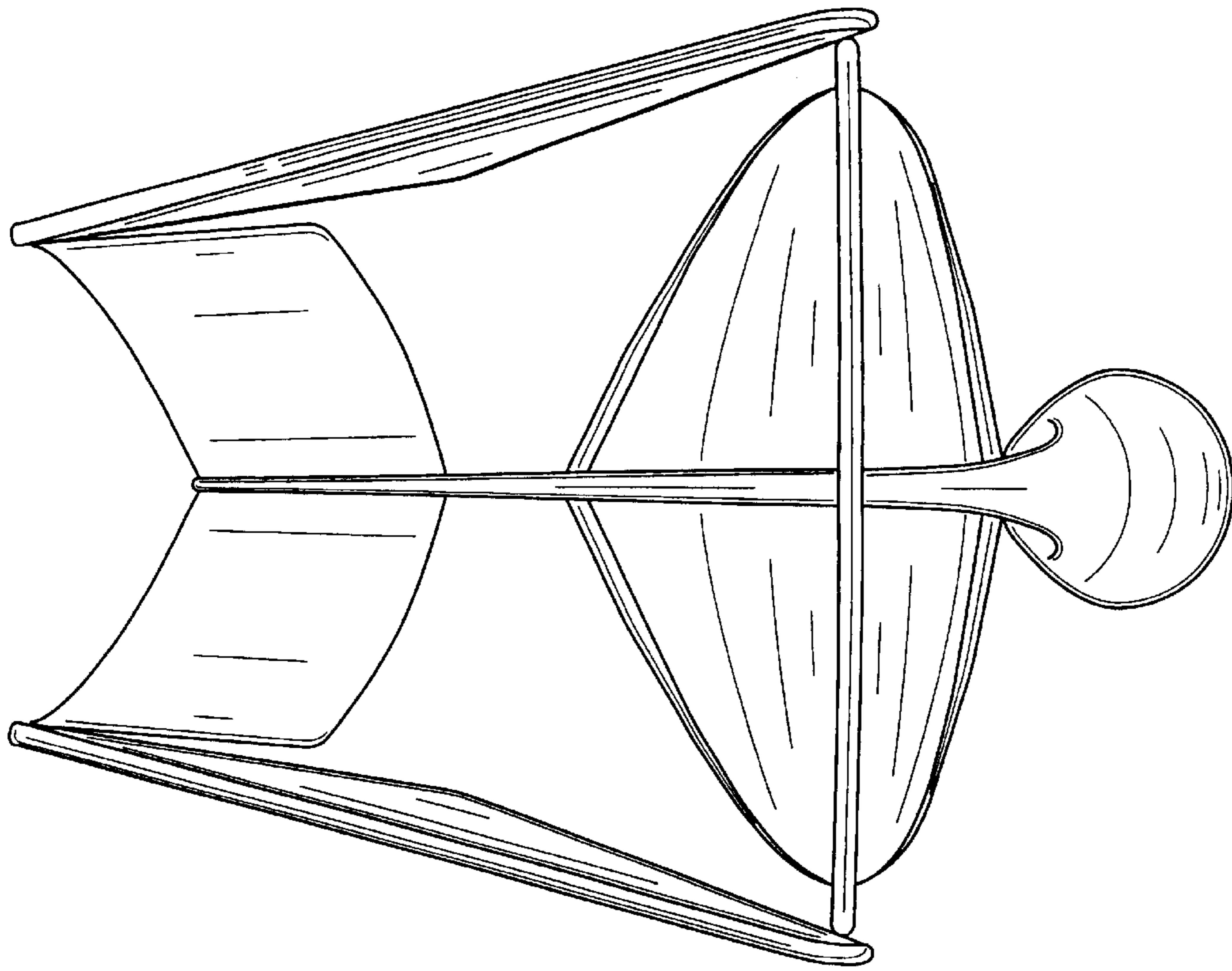

FIG. 4

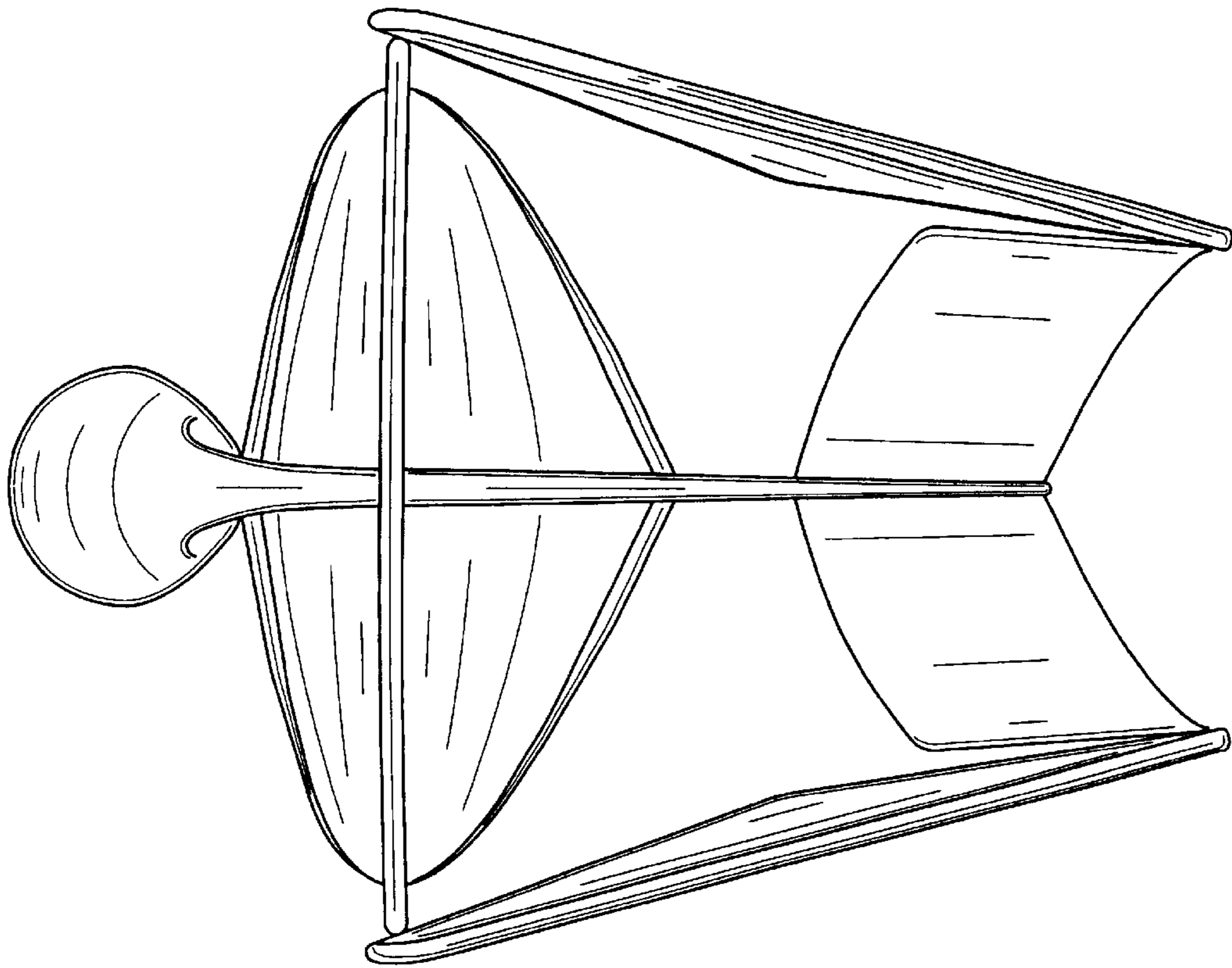

FIG. 5

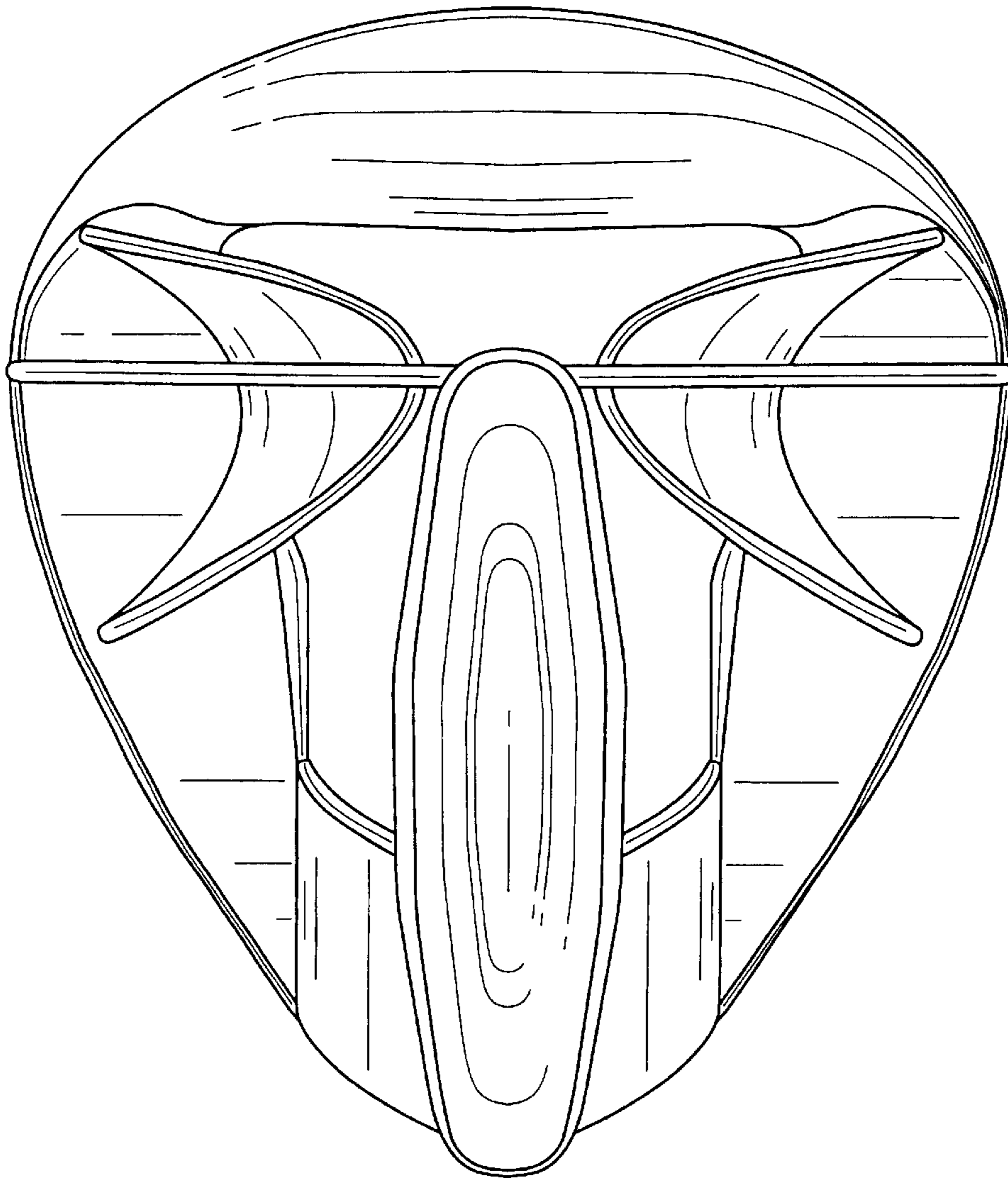

FIG. 6

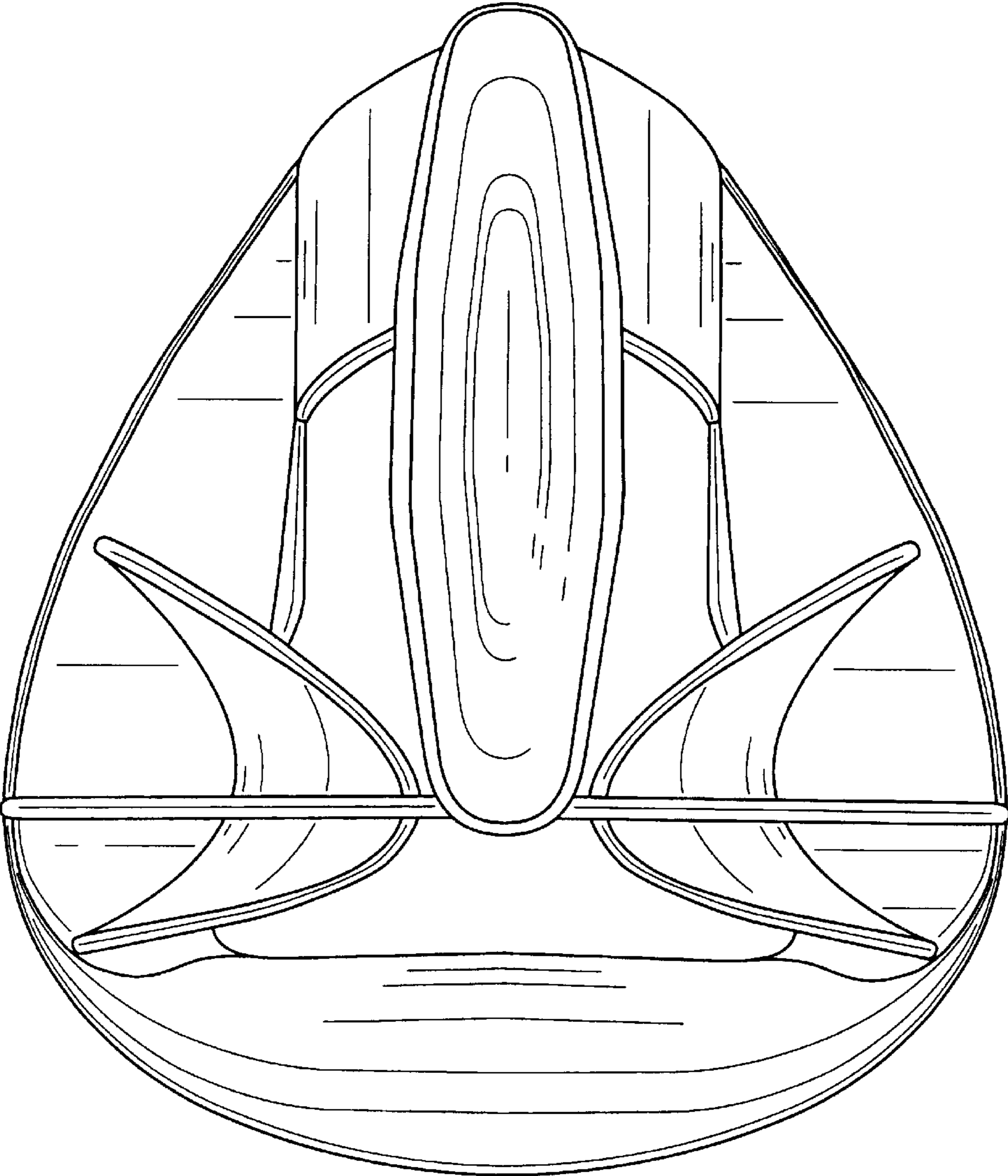

FIG. 7