



US00D523069S

(12) **United States Design Patent**
Akahane et al.

(10) **Patent No.:** **US D523,069 S**

(45) **Date of Patent:** **** Jun. 13, 2006**

(54) **PRINTER**

(75) Inventors: **Manabu Akahane**, Nagano-ken (JP);
Makoto Kobayashi, Nagano-ken (JP);
Hiroyuki Yoda, Nagano-ken (JP);
Takayuki Iijima, Nagano-ken (JP)

(73) Assignee: **Seiko Epson Corporation**, Tokyo (JP)

(**) **Term:** **14 Years**

(21) Appl. No.: **29/189,423**

(22) Filed: **Sep. 5, 2003**

(30) **Foreign Application Priority Data**

Mar. 7, 2003 (JP) 2003-006081

(51) **LOC (8) Cl.** **18-02**

(52) **U.S. Cl.** **D18/50**

(58) **Field of Classification Search** D18/50,
D18/53, 54, 54.1, 55, 19, 36-41; D14/420-425,
D14/462-470, 349; 400/613, 613.1, 613.2,
400/613.3, 613.4, 690.1-690.4, 691-694
See application file for complete search history.

(56) **References Cited**

U.S. PATENT DOCUMENTS

D281,256 S * 11/1985 Yamamoto D18/55

D326,110 S * 5/1992 Tashiro et al. D18/55
D389,861 S * 1/1998 Kobayashi et al. D18/55
D421,455 S * 3/2000 Kobayashi et al. D18/54
D425,552 S * 5/2000 Kobayashi et al. D18/54
D441,394 S * 5/2001 Kobayashi et al. D18/54
D474,501 S * 5/2003 Hayashi D18/55

* cited by examiner

Primary Examiner—Louis S. Zarfes

Assistant Examiner—Anhdao Doan

(74) *Attorney, Agent, or Firm*—Sughrue Mion, PLLC

(57) **CLAIM**

The ornamental design for a printer, as shown and described.

DESCRIPTION

FIG. 1 is a perspective view of the top, front and right side of a printer showing our new design; FIG. 2 is a front elevational view thereof; FIG. 3 is a rear elevational view thereof; FIG. 4 is a left side elevational view thereof; FIG. 5 is a right side elevational view thereof; FIG. 6 is a top plan view thereof; FIG. 7 is a bottom plan view thereof; and, FIG. 8 is a view similar to FIG. 1 with the paper holder trays in the extended position.

1 Claim, 6 Drawing Sheets

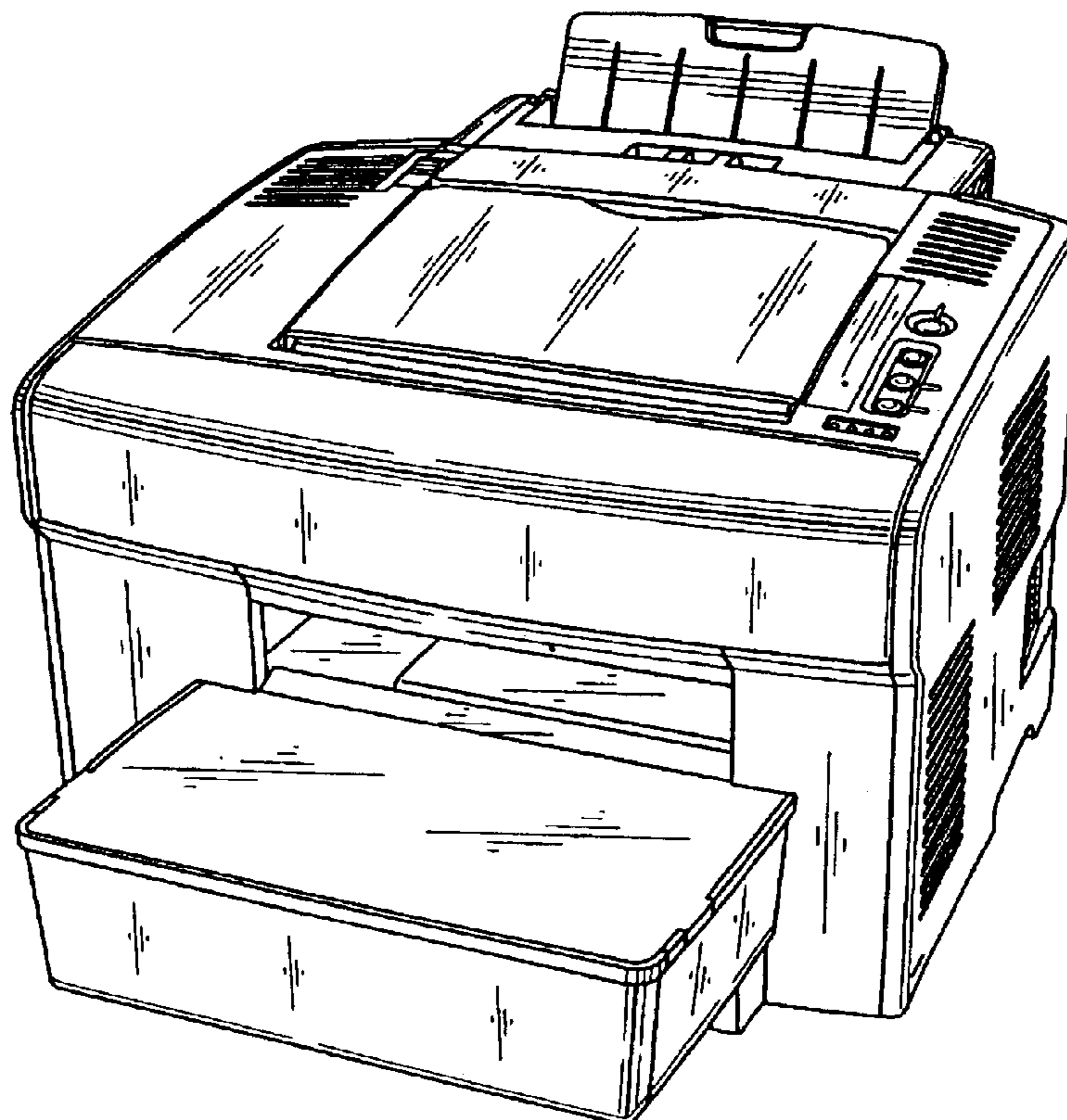

FIG. 1

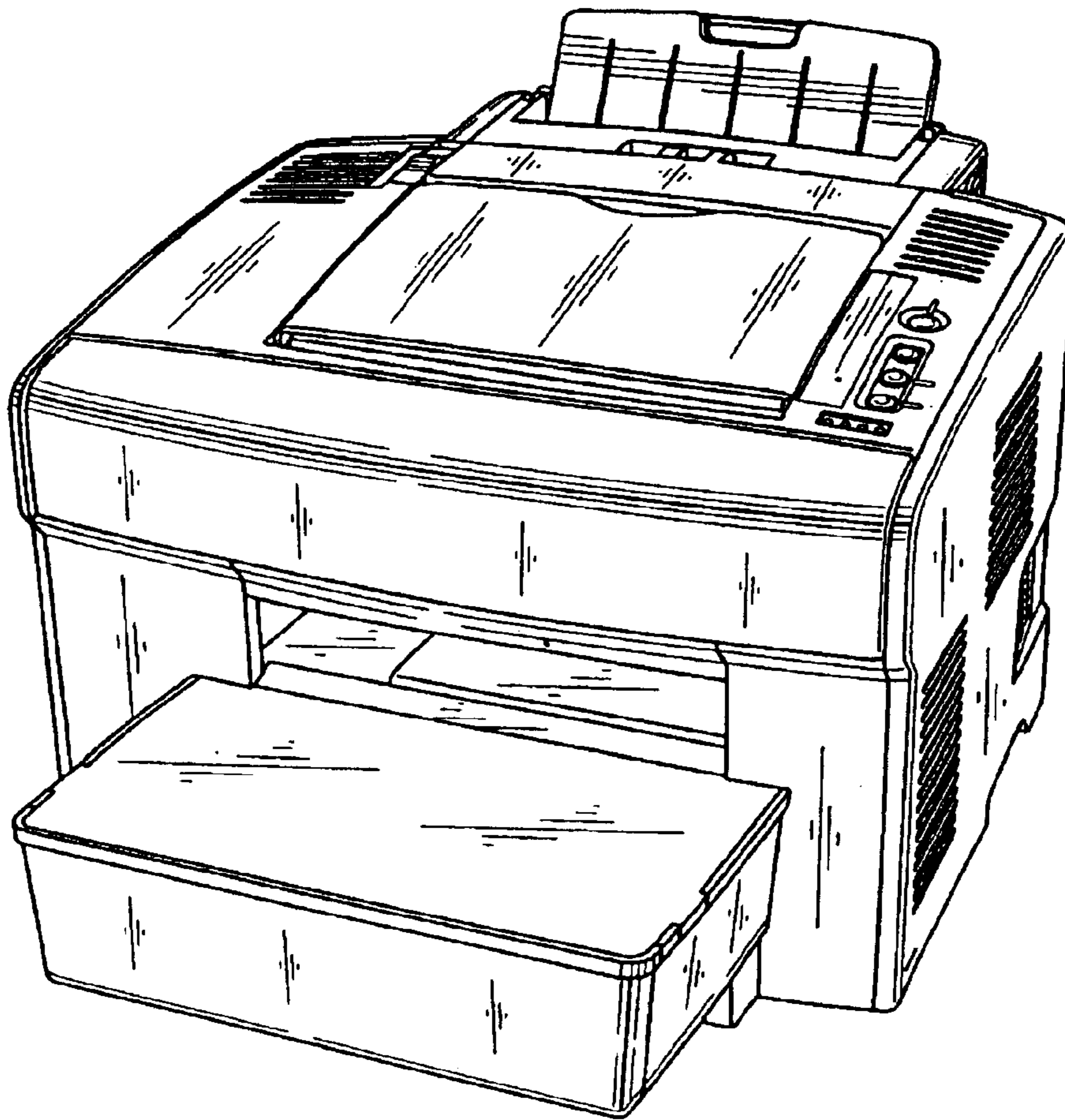

FIG. 2

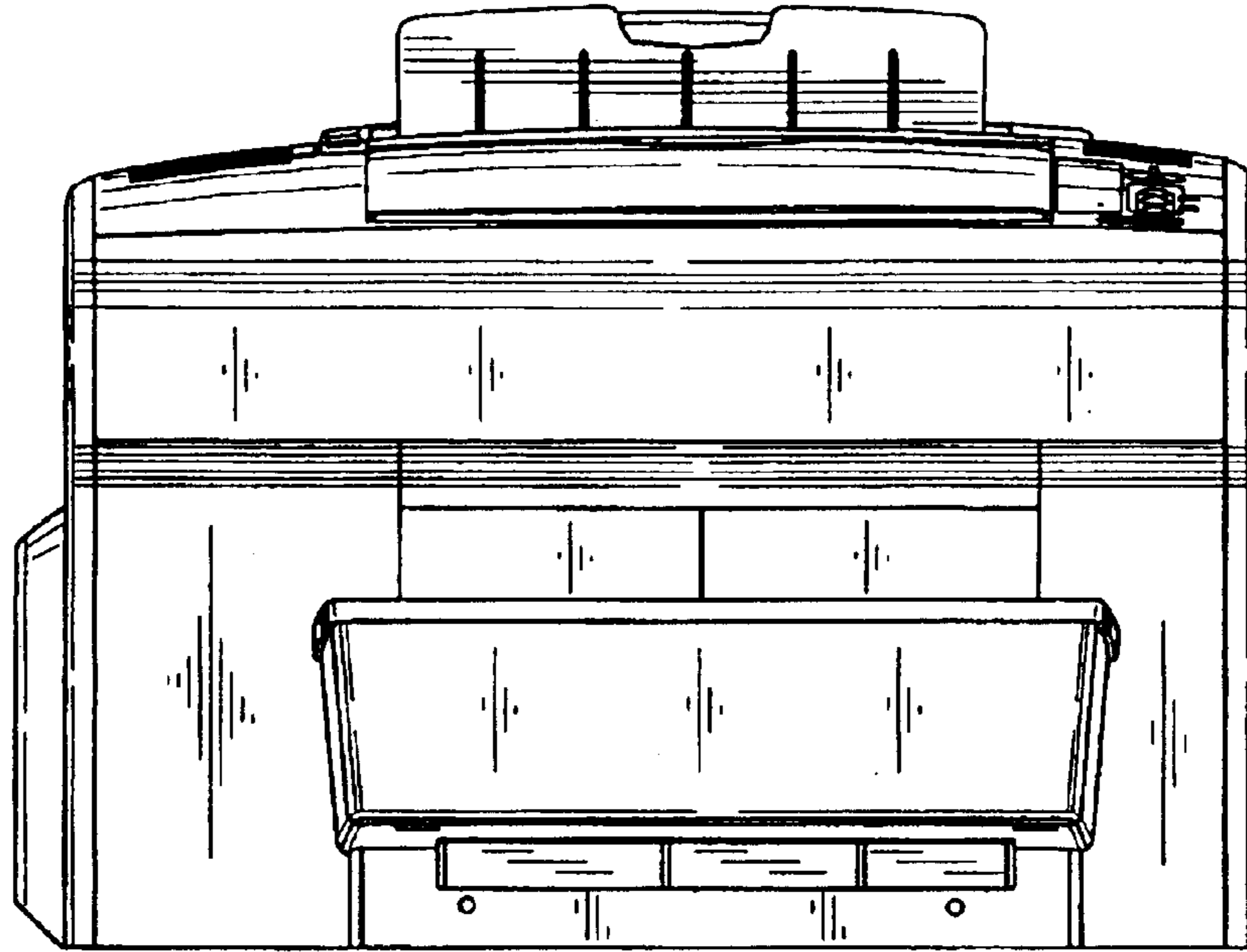

FIG. 3

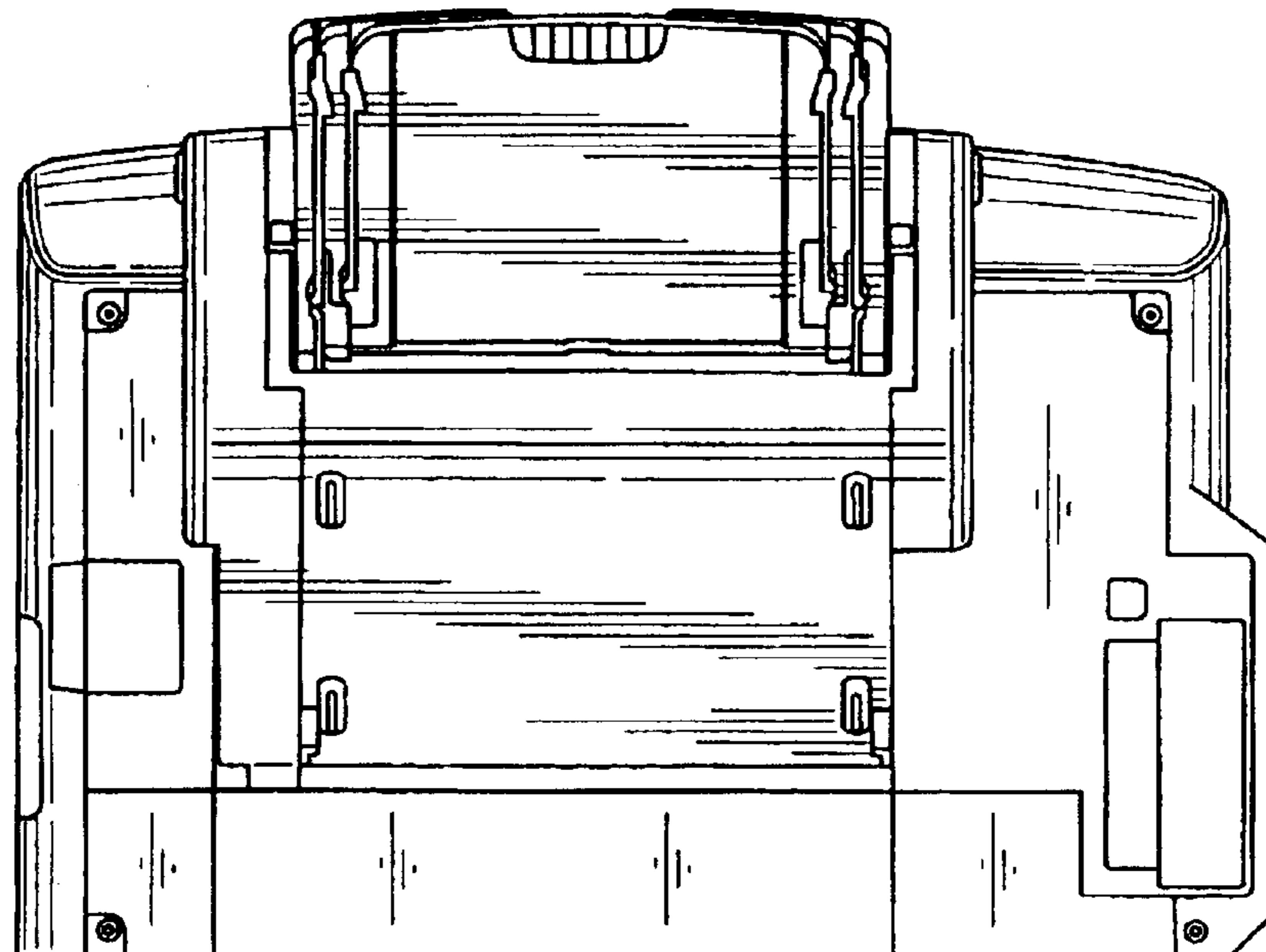

FIG. 4

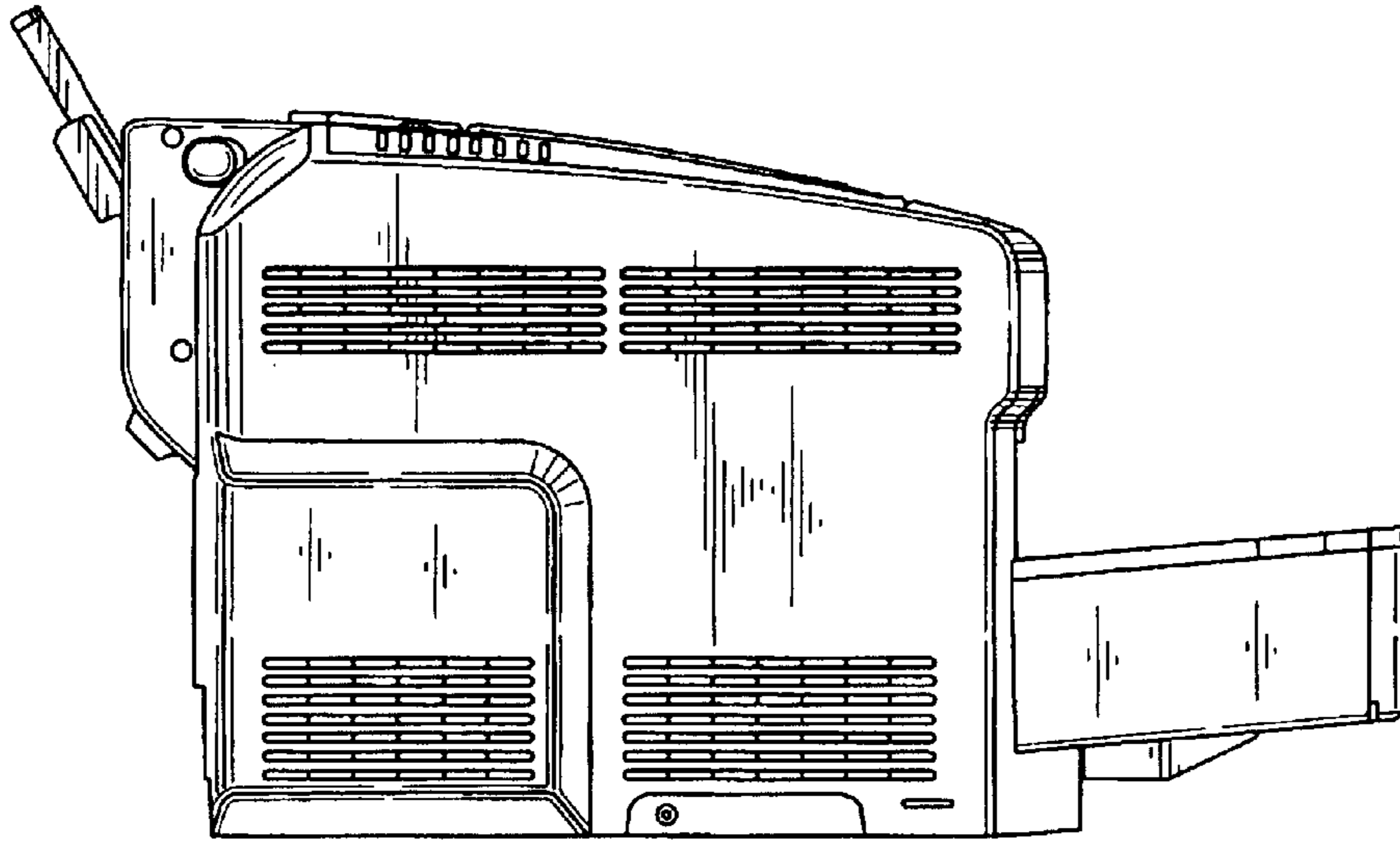

FIG. 5

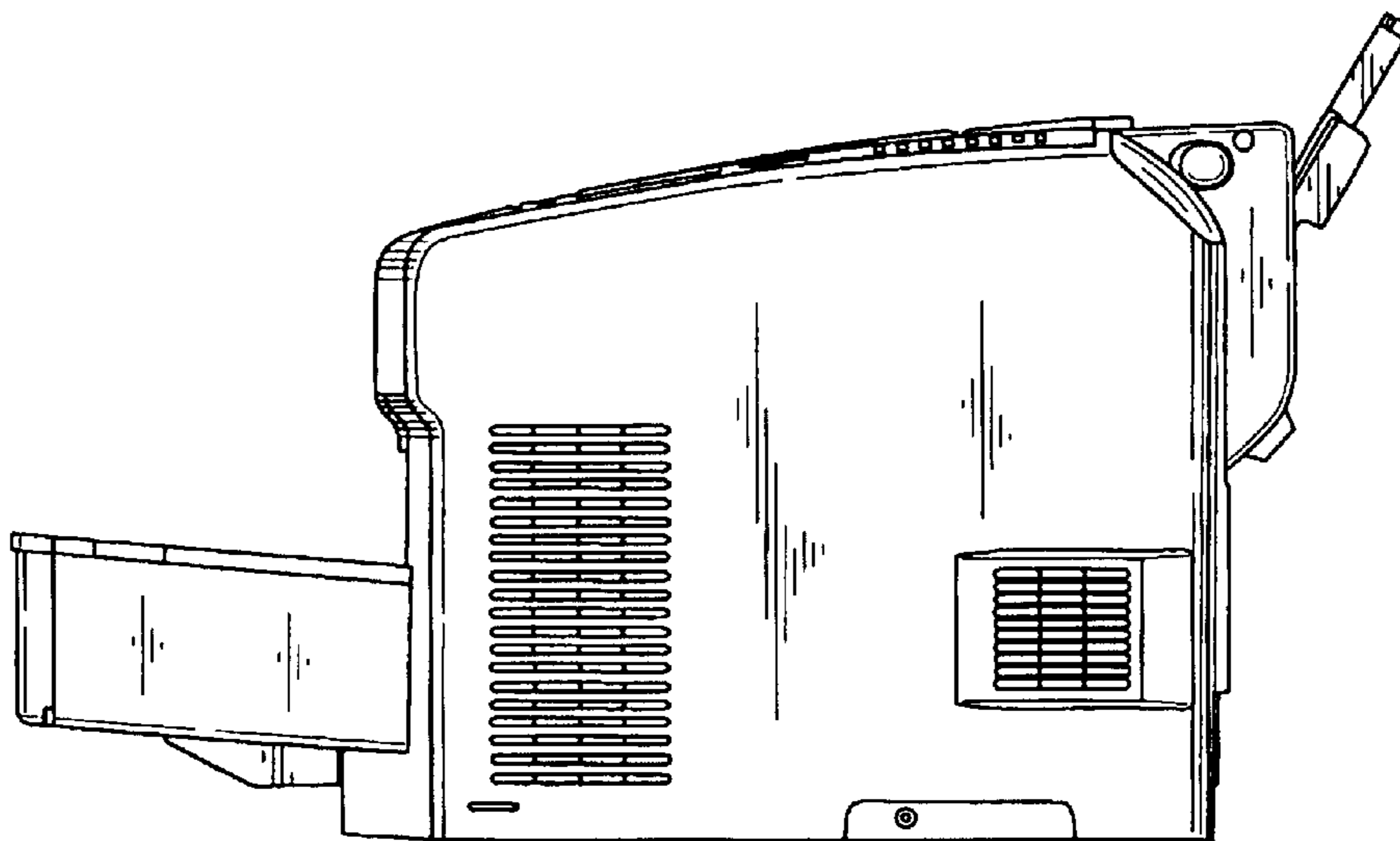

FIG. 6

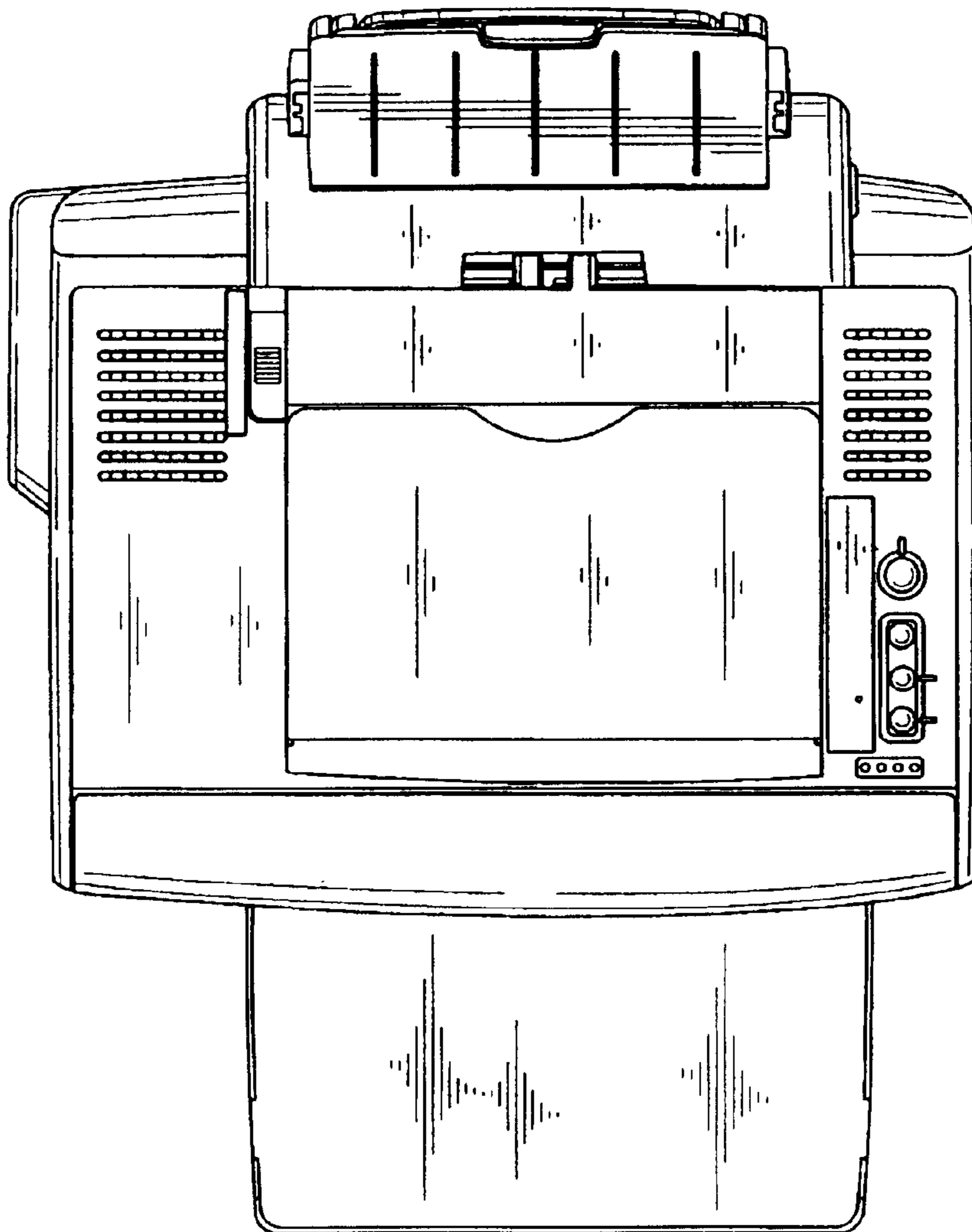

FIG. 7

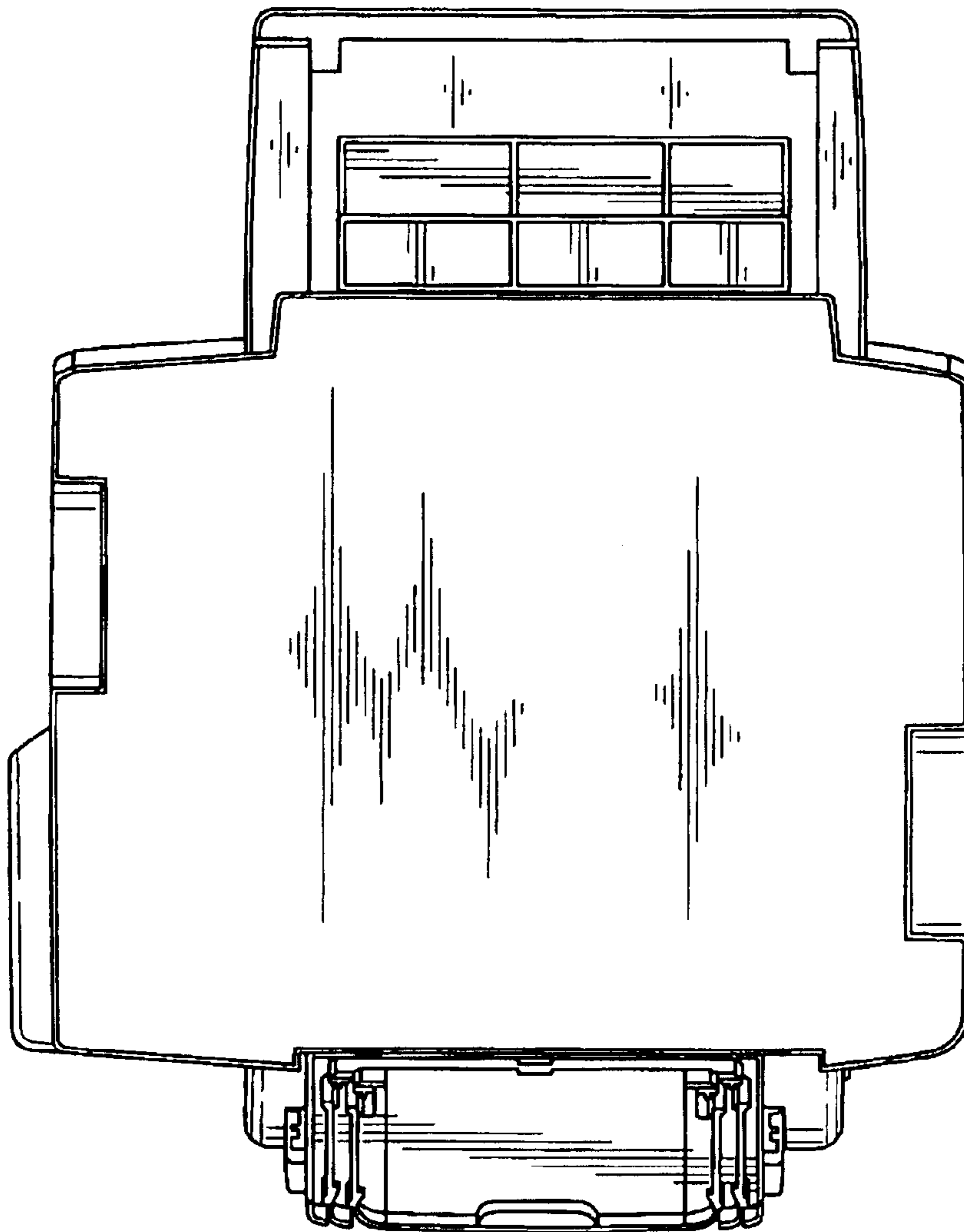

FIG. 8

