

US00D523062S

(12) **United States Design Patent**
Tu

(10) **Patent No.:** **US D523,062 S**

(45) **Date of Patent:** **** Jun. 13, 2006**

(54) **PRINT CARTRIDGE**

(75) Inventor: **Chun-Chang Tu**, Taipei (TW)

(73) Assignee: **Hi-Touch Imaging Technologies Co., Ltd.**, Pan-Chiao (TW)

(**) Term: **14 Years**

(21) Appl. No.: **29/210,939**

(22) Filed: **Aug. 10, 2004**

(30) **Foreign Application Priority Data**

May 28, 2004 (TW) 93303161

(51) **LOC (8) Cl.** **18-01**

(52) **U.S. Cl.** **D18/12**

(58) **Field of Classification Search** D18/12,
D18/36, 40, 43, 44, 56; D16/237, 246-250;
D14/474-484; 399/24-28, 110-112, 116,
399/119, 121, 122, 222-224; 347/49, 86,
347/87, 214; 400/194, 196, 207, 208

See application file for complete search history.

(56) **References Cited**

U.S. PATENT DOCUMENTS

- 3,614,012 A * 10/1971 Edelman et al. D14/481
- 4,160,605 A * 7/1979 Neubaum 400/208
- 4,973,983 A * 11/1990 Yamamoto et al. 347/214
- D327,495 S * 6/1992 Nagai D18/56
- 5,331,378 A * 7/1994 Baker et al. 399/111
- 5,352,049 A * 10/1994 Shiraishi et al. 400/208

- D355,436 S * 2/1995 Suwa D18/12
- D361,592 S * 8/1995 Niwano D18/56
- D383,743 S * 9/1997 Suwa et al. D18/56
- 5,709,485 A * 1/1998 Kohno 400/208
- D397,142 S * 8/1998 Hammill et al. D18/56
- D418,860 S * 1/2000 Shimoyama et al. D18/12
- D420,696 S * 2/2000 Yung et al. D18/12
- D464,670 S * 10/2002 Du D18/12
- 6,624,836 B1 * 9/2003 Sakuta et al. 347/214
- 2005/0052523 A1 * 3/2005 Kaida et al. 347/214
- 2005/0129444 A1 * 6/2005 Igi et al. 400/207
- 2005/0201806 A1 * 9/2005 Yamamoto 400/208

* cited by examiner

Primary Examiner—Caron D. Veynar

Assistant Examiner—Garth Rademaker

(74) *Attorney, Agent, or Firm*—Winston Hsu

(57) **CLAIM**

The ornamental design for a print cartridge, as shown and described.

DESCRIPTION

FIG. 1 is a perspective view of a print cartridge showing my new design;

FIG. 2 is a top plan view thereof;

FIG. 3 is a front view thereof;

FIG. 4 is a right view thereof;

FIG. 5 is a rear view thereof;

FIG. 6 is a left view thereof; and,

FIG. 7 is a bottom plan view thereof.

1 Claim, 7 Drawing Sheets

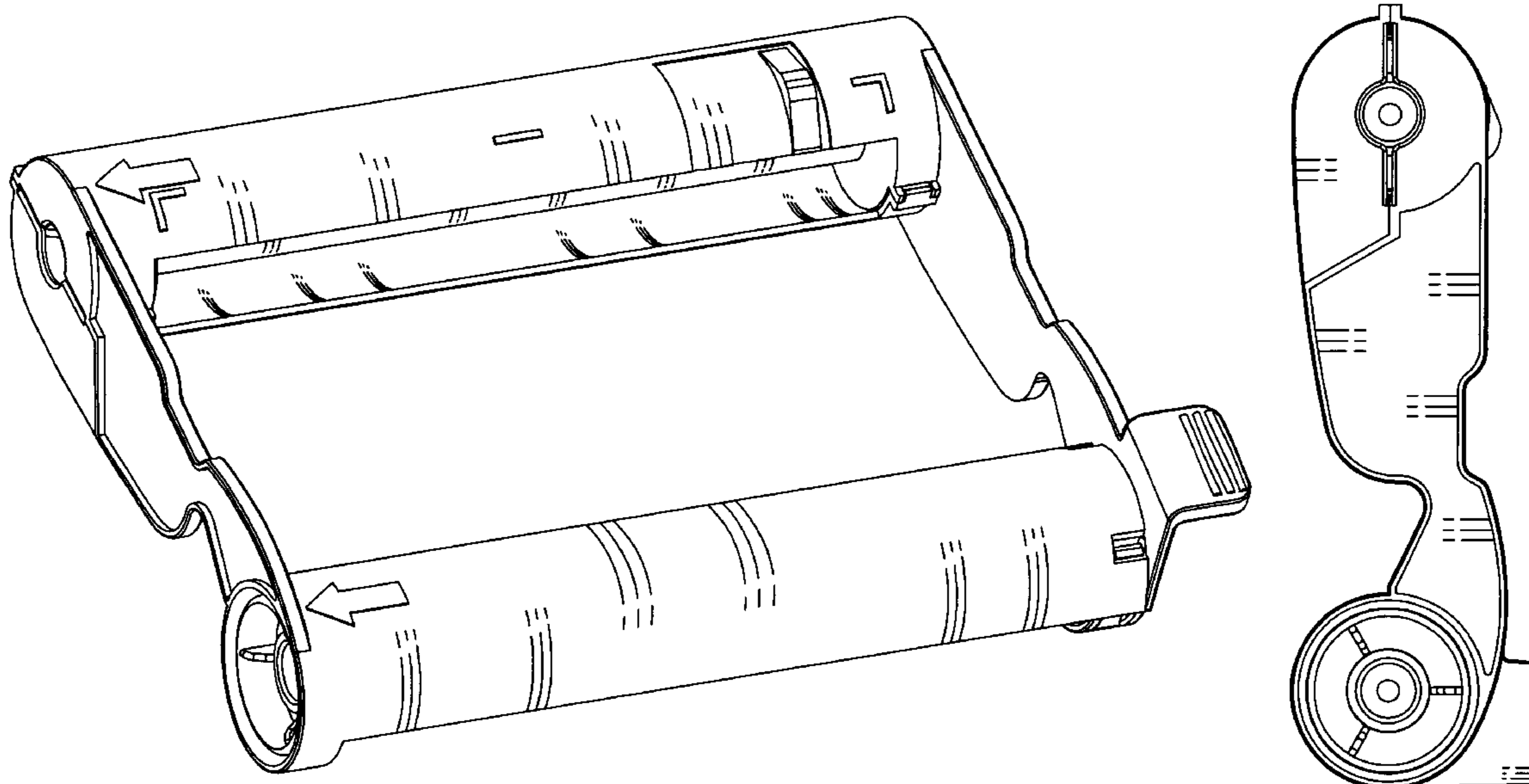

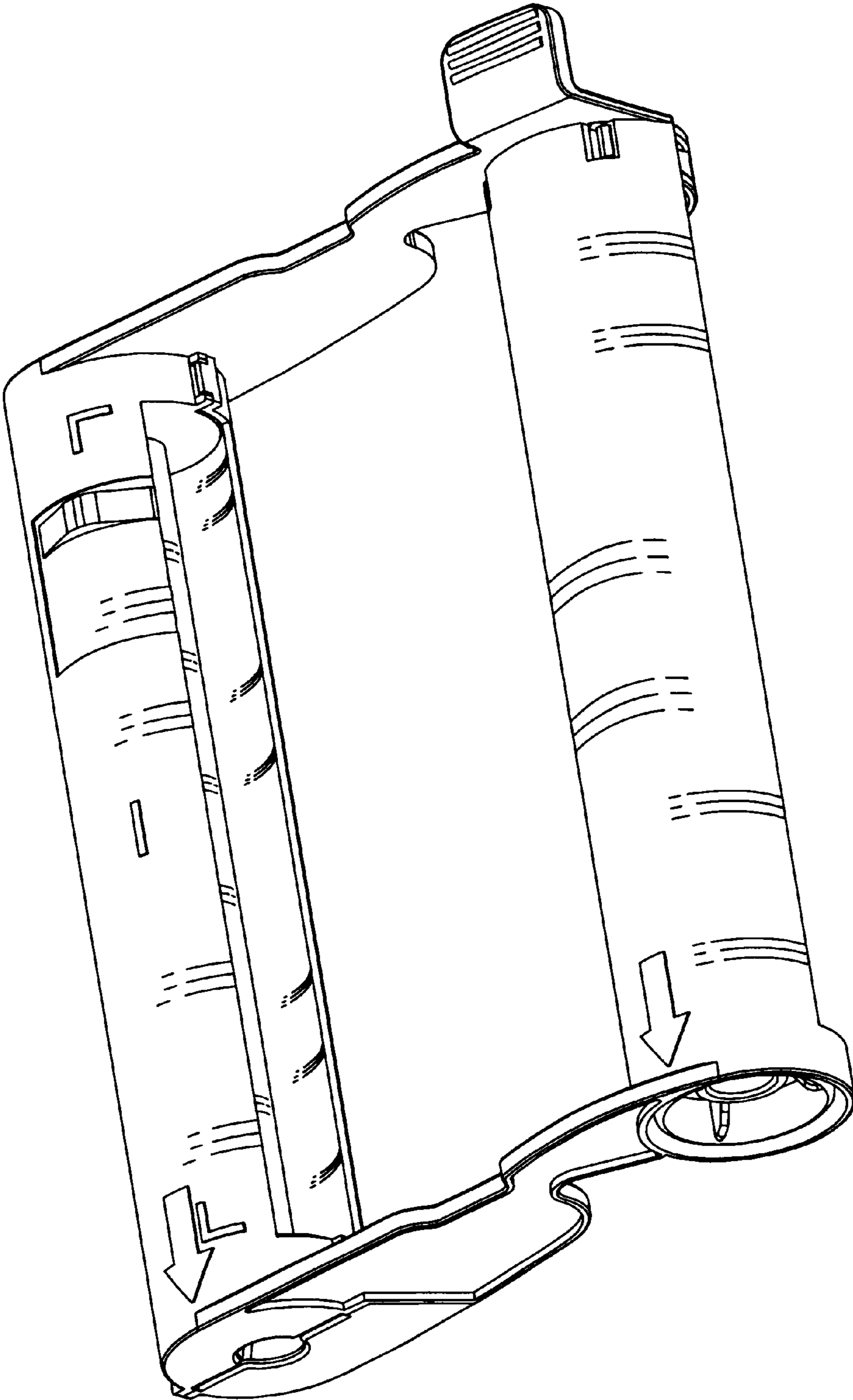

Fig. 1

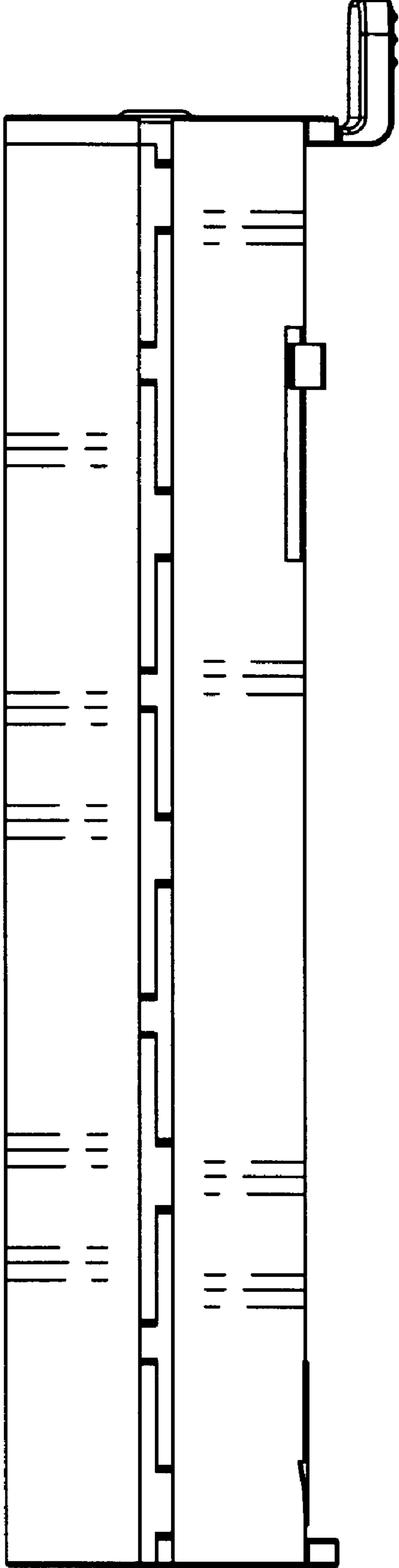

Fig. 2

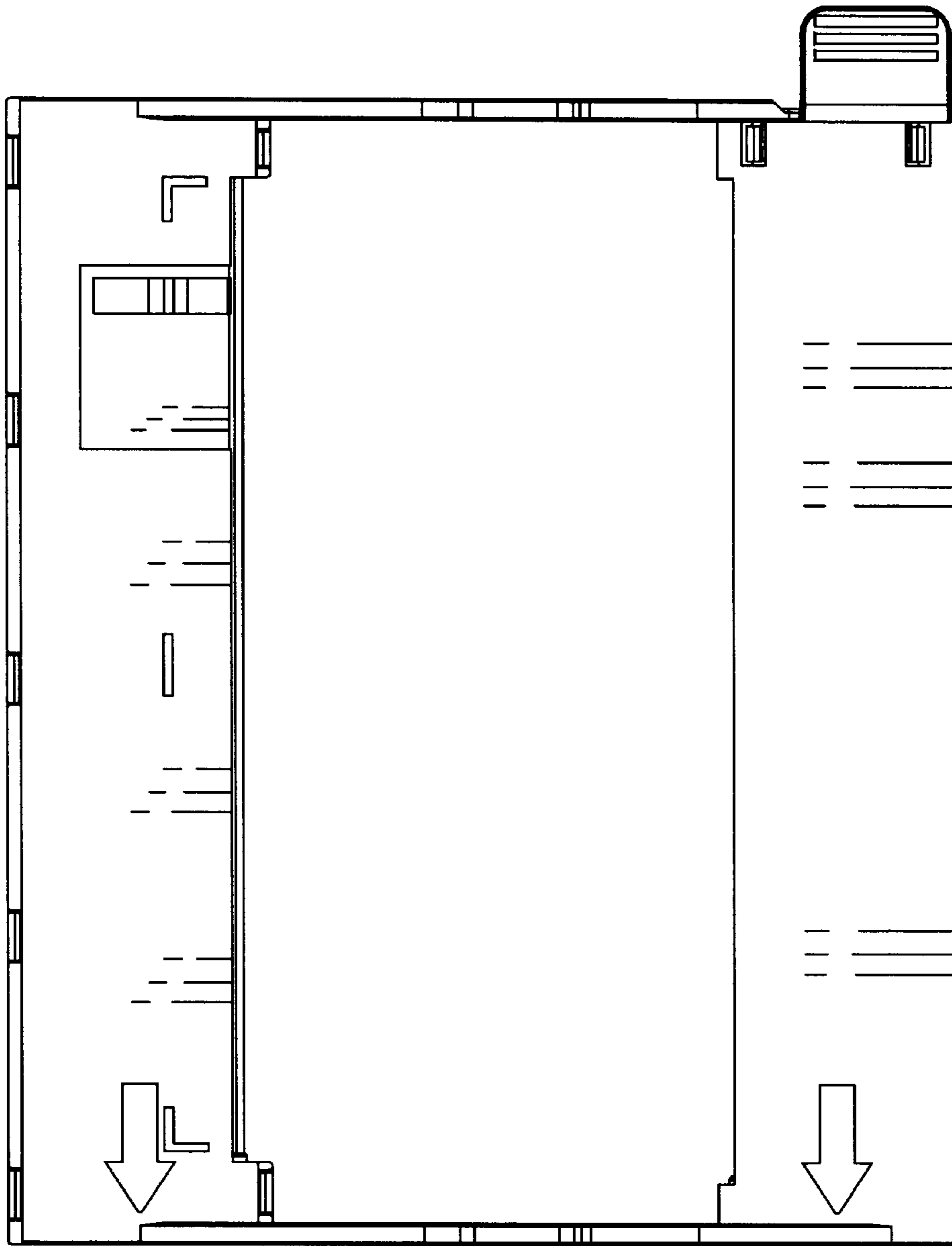

Fig. 3

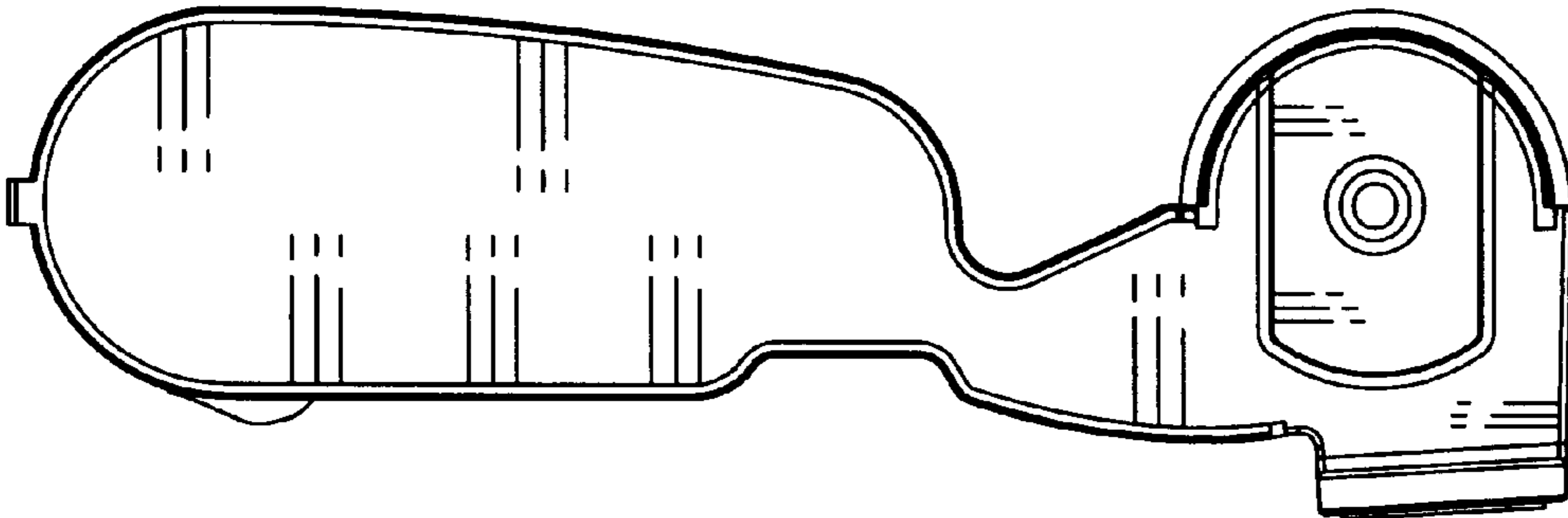

Fig. 4

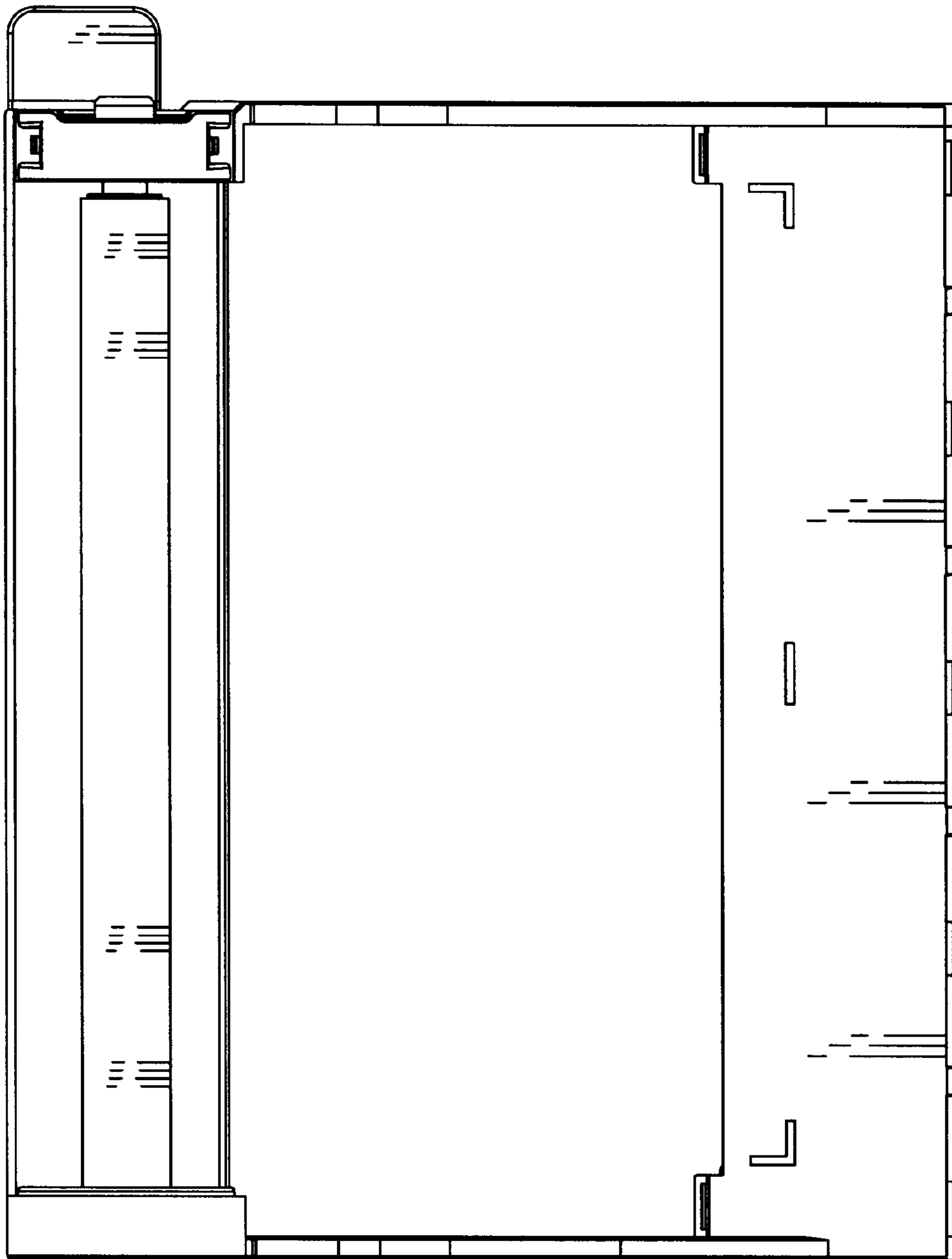

Fig. 5

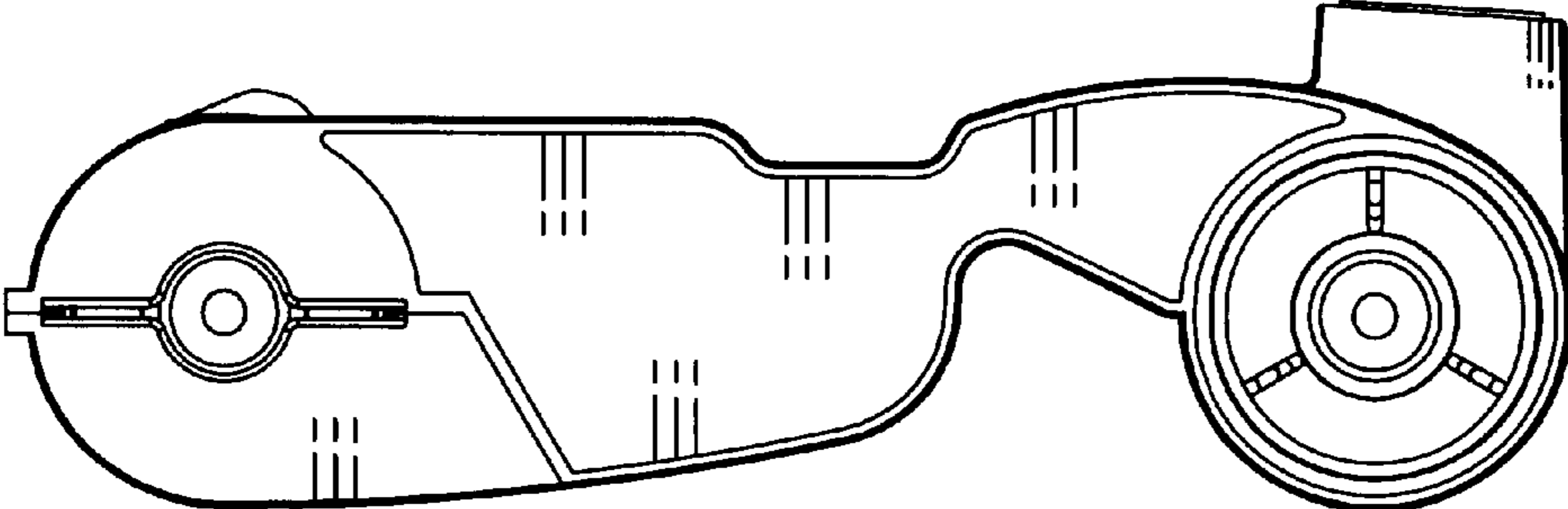

Fig. 6

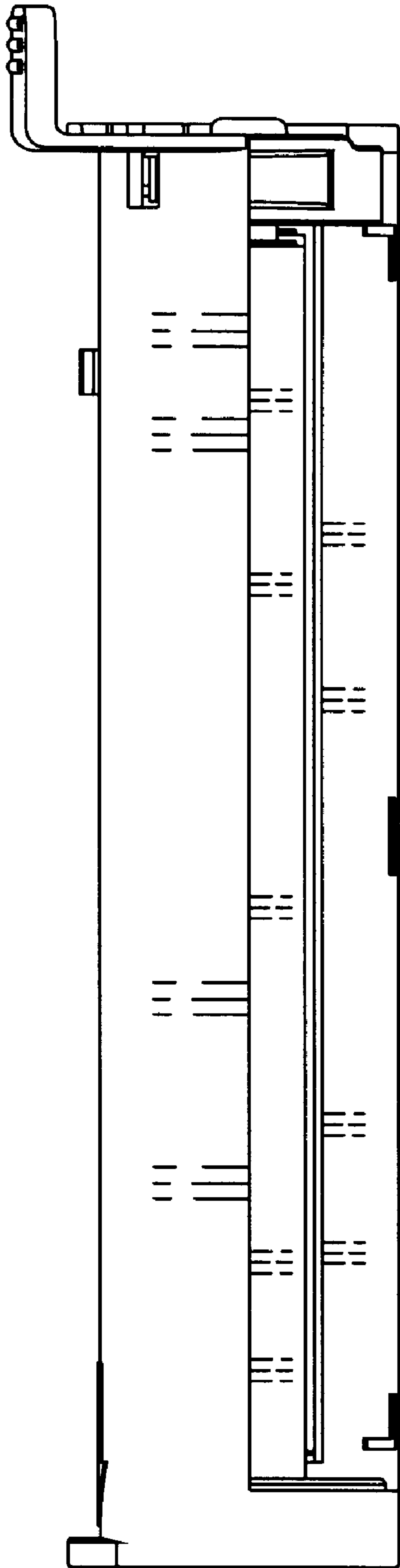

Fig. 7